



# içindekiler

## şalt grubu

|   |   |
|---|---|
| Araç Şarjları, Akü Takviye ve Taşınabilir Şişirme Pompası | 2 |
| Şalt Ürünleri   | 4 |

## anahtar priz grubu

|                            |    |
|----------------------------|----|
| Modüler Sistem             | 32 |
| <b>Rita Premium Serisi</b> | 39 |
| Rita Serisi                | 41 |
| Elitra Plus Serisi         | 48 |
| Candela Serisi             | 53 |
| Bella Serisi               | 59 |
| Nora Serisi                | 61 |
| Bron Serisi                | 63 |
| Grup priz ve aksesuarlar   | 65 |

## kablo kanalları, plastik, tesisat ve aydınlatma grubu

|   |     |
|---|-----|
| Canalex serisi kapalı tip kablo kanalları         | 74  |
| Eko serisi kapalı tip kablo kanalları             | 74  |
| Yapışkan bantlı kapalı tip kablo kanalları        | 74  |
| Meks serisi kapalı tip kablo kanalları            | 75  |
| Meks serisi klima kanalı ve aksesuarları          | 76  |
| Tavan köşe ve süpürgelik kablo kanalları          | 76  |
| Tezgah süpürgeliği                                | 76  |
| Balık sırtı zemin kanalları                       | 76  |
| H.Free Flaret kanal ve aksesuarları               | 77  |
| Kanal aksesuarları                                | 78  |
| Meks plus serisi için priz setleri                | 81  |
| Kanal için ups ve enerji prizleri 45x45           | 82  |
| Sidem serisi renkli kablo kanalları               | 83  |
| Sidem serisi süpürgelikler ve aksesuarları        | 83  |
| Comfort W otomat kutuları                         | 88  |
| Comfort zayıf akım kutuları                       | 89  |
| Meksbox W otomat kutuları                         | 90  |
| H. Free spiraller                                 | 91  |
| Plastik spiraller                                 | 92  |
| Hdpe koruge borular                               | 92  |
| Rögar kutuları                                    | 92  |
| Eko serisi çelik ve izole kaplı spiraller         | 93  |
| Meks serisi çelik ve izole kaplı spiraller        | 94  |
| PVC boy borular                                   | 95  |
| PVC Boru aksesuarları                             | 95  |
| H.Free borular                                    | 96  |
| Eko Serisi borular                                | 97  |
| Kalın boy boru ve dirsek-muflar                   | 99  |
| Polietilen yeraltı boruları                       | 99  |
| Fiber kılavuz, çelik susta ve plastik sustalar    | 100 |
| Kasa, buat ve kapakları                           | 100 |
| Galvaniz sac kroşeler, çivili kroşeler, dübelller | 102 |
| Elektrik izolasyon bandı                          | 102 |

|                                    |     |
|------------------------------------|-----|
| Kapı zilleri ve trafoları          | 103 |
| Yangın algılama ve ikaz sistemleri | 104 |
| ME-FAN aspiratörler                | 105 |
| Mutlusan aspiratörler              | 106 |
| Aydınlatmalı tavan vantilatörü     | 107 |
| Exit - acil aydınlatma armatürleri | 108 |
| Led armatür ve armatür çeşitleri   | 109 |
| Aplikler                           | 111 |
| Solar bahçe aplikleri              | 113 |
| Bahçe armatürleri                  | 114 |

## pano ve endüstriyel ürün grubu

|  |     |
|--|-----|
| Promex delikli kanallar                            | 118 |
| Delikli kablo kanalları                            | 120 |
| Meksplus Abs Panolar                               | 121 |
| Promex Abs panoları ve otomat panoları             | 122 |
| Abs pano aksesuarları                              | 124 |
| <b>Sayaç Panoları</b>                              | 125 |
| Pano prizleri                                      | 126 |
| Higrostat ve termostatlar                          | 127 |
| Promex ve Eko fan tepe fanları                     | 128 |
| Filtreli fanlar ve pano ısıtıcıları                | 130 |
| Promex Ray Klemens ve Aksesuarları                 | 132 |
| Alev yaymayan sıra klemensler                      | 142 |
| Geçmeli ve tırmıklı tip buat klemensler            | 143 |
| Dağıtım üniteleri                                  | 144 |
| UV Kablo bağları, Mutlusan kablo bağları           | 145 |
| Yapışkan kroşeler, Kablo toplama & pano spiralleri | 146 |
| R-Meks plastik kablo rakorları                     | 147 |
| Promex plastik kablo rakoru                        | 148 |
| Polyamid spiral rakorları                          | 149 |
| Yüksükler  | 151 |
| Baralar, raylar ve topraklama çubuğu               | 158 |
| Skp çeşitleri                                      | 159 |
| Cee norm fiş ve prizler                            | 160 |
| Sanayi tipi kauçuk fiş ve prizleri                 | 163 |
| Termoplastik buatlar ve kombinasyon kutuları       | 165 |
| Kombinasyon panoları                               | 167 |
| Kumanda ve vinç kutuları                           | 168 |
| Butonlar ve potansiyometre                         | 170 |
| Ampermetre ve voltmetre                            | 172 |

**Mutlusan**  
**CHARGEBOX**



MUTLUSAN CHARGEBOX EV CHARGER  
22 kW - 7 kW

Senin Enerjin  
Senin Mutluluğun...



Kullanım Kılavuzu  
İçin Lütfen Okutunuz



**TAŞINABİLİR** MUTLUSAN CHARGEBOX  
EV CHARGER  
3.5 kW

10.000  
mAh

**ÇOK FONKSİYONLU  
AKÜ TAKVİYE CİHAZI**



- Akıllı AKÜ Takviyesi
- Dijital Şişirme Pompası
- Acil Aydınlatma Işıkları
- Kamp Cihazları Şarjı
- Mobil Cihaz Şarjı

3.500  
mAh

**TAŞINABİLİR  
AKILLI ŞİŞİRME POMPASI**



- Dijital Şişirme Pompası
- Acil Aydınlatma Işıkları
- Kamp Cihazları Şarjı
- Mobil Cihaz Şarjı

| Ürün Kodu      | Ürün Adı                           | Adet | Fiyat (₺) |
|----------------|------------------------------------|------|-----------|
| 999 999 530001 | ÇOK FONKSİYONLU AKÜ TAKVİYE CİHAZI | 1    | 8.356,75  |

| Ürün Kodu      | Ürün Adı                           | Adet | Fiyat (₺) |
|----------------|------------------------------------|------|-----------|
| 999 999 530002 | TAŞINABİLİR AKILLI ŞİŞİRME POMPASI | 1    | 3.633,37  |

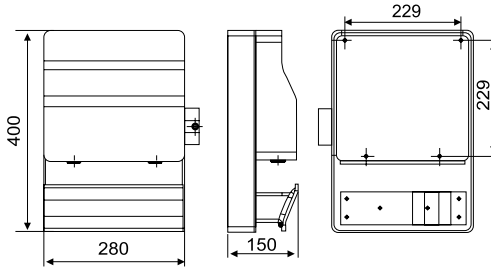

## ARAÇ ŞARJ CİHAZLARI

| Ürün Kodu                                  | Ürün Adı  | Kutu Adedi | Fiyat (\$) |
|--|---|------------|------------|
| <b>22 kW ARAÇ ŞARJ CİHAZLARI - TRİFAZE</b> |   |            |            |
| 001 191 022001 00 00                       | MUTLUSAN CHARGEBOX 22 kW EV CHARGER - <b>SOKETLİ</b>                | 1          | 1.800 \$   |
| 001 191 022002 00 00                       | MUTLUSAN CHARGEBOX 22 kW EV CHARGER - <b>KABLOLU</b>                | 1          | 2.050 \$   |
| 001 191 022011 00 00                       | MUTLUSAN CHARGEBOX 22 kW RFID EKLENTİLİ EV CHARGER - <b>SOKETLİ</b> | 1          | 2.000 \$   |
| 001 191 022012 00 00                       | MUTLUSAN CHARGEBOX 22 kW RFID EKLENTİLİ EV CHARGE - <b>KABLOLU</b>  | 1          | 2.250 \$   |
| 001 191 000054 00 00                       | MUTLUSAN CHARGEBOX STAND  | 1          | 525 \$     |

| Ürün Kodu                                  | Ürün Adı   | Kutu Adedi | Fiyat (\$) |
|--|--|------------|------------|
| <b>7 kW ARAÇ ŞARJ CİHAZLARI - MONOFAZE</b> |  |            |            |
| 001 191 070001 00 00                       | MUTLUSAN CHARGEBOX 7 kW EV CHARGER - <b>SOKETLİ</b>                | 1          | 1.550 \$   |
| 001 191 070002 00 00                       | MUTLUSAN CHARGEBOX 7 kW EV CHARGER - <b>KABLOLU</b>                | 1          | 1.750 \$   |
| 001 191 070011 00 00                       | MUTLUSAN CHARGEBOX 7 kW RFID EKLENTİLİ EV CHARGER - <b>SOKETLİ</b> | 1          | 1.750 \$   |
| 001 191 070012 00 00                       | MUTLUSAN CHARGEBOX 7 kW RFID EKLENTİLİ EV CHARGER - <b>KABLOLU</b> | 1          | 1.950 \$   |

| Ürün Kodu                                    | Ürün Adı                                       | Kutu Adedi | Fiyat (\$) |
|--|--|------------|------------|
| <b>3,5 kW ARAÇ ŞARJ CİHAZI - TAŞINABİLİR</b> |  |            |            |
| 001 191 030000 00 00                         | MUTLUSAN CHARGEBOX 3.5 kW - <b>TAŞINABİLİR</b> | 1          | 850 \$     |

| Ürün Kodu | Ürün Adı | Kutu Adedi | Fiyat (\$) |
|-----------|----------|------------|------------|
|-----------|----------|------------|------------|

## ŞARJ CİHAZI KABLOLU FİŞLER (5 MT)

|                |  |   |        |
|----------------|--|---|--------|
| 999 983 000010 | MUTLUSAN CHARGEBOX 7 kW ÇİFT TARAFLI KABLOLU FİŞ                   | 1 | 790 \$ |
| 999 983 000012 | MUTLUSAN CHARGEBOX 22 kW ÇİFT TARAFLI KABLOLU FİŞ                  | 1 | 940 \$ |
| 999 983 000064 | MUTLUSAN CHARGEBOX 7 kW ÇİFT TARAFLI KABLOLU FİŞ - <b>SİRALLİ</b>  | 1 | 640 \$ |
| 999 983 000066 | MUTLUSAN CHARGEBOX 22 kW ÇİFT TARAFLI KABLOLU FİŞ - <b>SİRALLİ</b> | 1 | 790 \$ |

| Ürün Kodu | Ürün Adı | Kutu Adedi | Fiyat (\$) |
|-----------|----------|------------|------------|
|-----------|----------|------------|------------|

## RFID KART

|                |                              |   |          |
|----------------|------------------------------|---|----------|
| 999 983 000050 | MUTLUSAN CHARGEBOX RFID KART | 1 | 20,65 \$ |
|----------------|------------------------------|---|----------|



## B - C - D TİPİ OTOMATİK SİGORTALAR

- Hata korumalı terminal bloklarına sahip terminal ve kontak konumu gösteren pencere ile daha yüksek güvenlik.
- Manyetik üflemlerle ark seperatörü açma - kapatma anında oluşan arkı güvenli bir şekilde söndürer.
- Kalıp ve fonksiyon parçalarının tümü, yüksek alev geciktirici ve yüksek sıcaklık dayanımı, aynı zamanda darbeye dayanıklı PA66 polyamid malzemeden yapılmıştır.



960°C'ye kadar alev iletmez. Kaliteli polyamid 66 malzeme

Renkli kontak konumu göstergesi, cihazın durumunun ve yalıtım fonksiyonunun görsel olarak gösterilmesini sağlar.

B/C/D tipi seçenekleriyle

6-10 kA kesme kapasitesi

Kurma kolunun pozisyonu ON-I konumunda akıma açık, O-OFF konumunda akıma kapalıdır.

Farklı amper değerlerinde üretilmiş olan bu otomatik sigortalar ya da diğer adıyla minyatür devre kesiciler, elektrik tesisatını ve sistemi aşırı akım ve kısa devrelere karşı korumak amacıyla tasarlanmış koruma ve anahtarlama devre elemanlarıdır. Devreden geçen akım, sigortaların nominal akımlarının belirli bir seviye üstüne çıkması durumunda ya da devrede bir kısa devre meydana gelmesi durumunda otomatik sigortalar elektrik akımını keserek kendinden sonraki sistemi korumaya almaktadır.



1 Kutup



2 Kutup



3 Kutup



4 Kutup

## OTOMATİK SİGORTA REFERANS KODU SEÇİMİ

| MTS                        | Kiloamper (kA) | Kutup Sayısı | Amper (A)       | Tip (Eğri) |
|----------------------------|----------------|--------------|-----------------|------------|
| Otomatik Sigorta Seri Kodu | 06/10          | 1/2/3/4      | XXX<br>1A...63A | B/C/D      |

**ÖRNEK REFERANS SEÇİMİ :**  
MTS06-2050C ( 6kA, 2 Kutup, 50A, C Tipi)

XXX: 001 (1A Otomatik Sigorta)  
XXX: 010 (10A Otomatik Sigorta)  
XXX: 100 (100A Otomatik Sigorta)



## B - C - D TİPİ OTOMATİK SİGORTALAR - 6kA (MCB)

### MTS-6 SERİSİ



| Kutup Sayısı | In (A) Anma Akımı | B Tipi Ürün Kodu | C Tipi Ürün Kodu | D Tipi Ürün Kodu | Kutu Adedi | Koli Adedi | Fiyat (\$) |
|--------------|-------------------|------------------|------------------|------------------|------------|------------|------------|
| 1P           | 1A                | MTS06-1001B      | MTS06-1001C      | MTS06-1001D      | 12         | 240        | 6,15 \$    |
|              | 2A                | MTS06-1002B      | MTS06-1002C      | MTS06-1002D      | 12         | 240        | 6,15 \$    |
|              | 3A                | MTS06-1003B      | MTS06-1003C      | MTS06-1003D      | 12         | 240        | 6,15 \$    |
|              | 4A                | MTS06-1004B      | MTS06-1004C      | MTS06-1004D      | 12         | 240        | 6,15 \$    |
|              | 5A                | MTS06-1005B      | MTS06-1005C      | MTS06-1005D      | 12         | 240        | 6,15 \$    |
|              | 6A                | MTS06-1006B      | MTS06-1006C      | MTS06-1006D      | 12         | 240        | 5,08 \$    |
|              | 10A               | MTS06-1010B      | MTS06-1010C      | MTS06-1010D      | 12         | 240        | 4,58 \$    |
|              | 16A               | MTS06-1016B      | MTS06-1016C      | MTS06-1016D      | 12         | 240        | 4,58 \$    |
|              | 20A               | MTS06-1020B      | MTS06-1020C      | MTS06-1020D      | 12         | 240        | 4,58 \$    |
|              | 25A               | MTS06-1025B      | MTS06-1025C      | MTS06-1025D      | 12         | 240        | 4,58 \$    |
|              | 32A               | MTS06-1032B      | MTS06-1032C      | MTS06-1032D      | 12         | 240        | 5,14 \$    |
|              | 40A               | MTS06-1040B      | MTS06-1040C      | MTS06-1040D      | 12         | 240        | 5,77 \$    |
|              | 50A               | MTS06-1050B      | MTS06-1050C      | MTS06-1050D      | 12         | 240        | 6,37 \$    |
| 63A          | MTS06-1063B       | MTS06-1063C      | MTS06-1063D      | 12               | 240        | 6,58 \$    |            |



|     |             |             |             |             |     |          |          |
|-----|-------------|-------------|-------------|-------------|-----|----------|----------|
| 2P  | 1A          | MTS06-2001B | MTS06-2001C | MTS06-2001D | 6   | 120      | 11,54 \$ |
|     | 2A          | MTS06-2002B | MTS06-2002C | MTS06-2002D | 6   | 120      | 11,54 \$ |
|     | 3A          | MTS06-2003B | MTS06-2003C | MTS06-2003D | 6   | 120      | 11,54 \$ |
|     | 4A          | MTS06-2004B | MTS06-2004C | MTS06-2004D | 6   | 120      | 11,54 \$ |
|     | 5A          | MTS06-2005B | MTS06-2005C | MTS06-2005D | 6   | 120      | 11,54 \$ |
|     | 6A          | MTS06-2006B | MTS06-2006C | MTS06-2006D | 6   | 120      | 9,62 \$  |
|     | 10A         | MTS06-2010B | MTS06-2010C | MTS06-2010D | 6   | 120      | 9,62 \$  |
|     | 16A         | MTS06-2016B | MTS06-2016C | MTS06-2016D | 6   | 120      | 9,62 \$  |
|     | 20A         | MTS06-2020B | MTS06-2020C | MTS06-2020D | 6   | 120      | 9,62 \$  |
|     | 25A         | MTS06-2025B | MTS06-2025C | MTS06-2025D | 6   | 120      | 9,62 \$  |
|     | 32A         | MTS06-2032B | MTS06-2032C | MTS06-2032D | 6   | 120      | 13,45 \$ |
|     | 40A         | MTS06-2040B | MTS06-2040C | MTS06-2040D | 6   | 120      | 13,45 \$ |
|     | 50A         | MTS06-2050B | MTS06-2050C | MTS06-2050D | 6   | 120      | 14,87 \$ |
| 63A | MTS06-2063B | MTS06-2063C | MTS06-2063D | 6           | 120 | 15,30 \$ |          |



|     |             |             |             |             |    |          |          |
|-----|-------------|-------------|-------------|-------------|----|----------|----------|
| 3P  | 1A          | MTS06-3001B | MTS06-3001C | MTS06-3001D | 4  | 80       | 18,99 \$ |
|     | 2A          | MTS06-3002B | MTS06-3002C | MTS06-3002D | 4  | 80       | 18,99 \$ |
|     | 3A          | MTS06-3003B | MTS06-3003C | MTS06-3003D | 4  | 80       | 18,99 \$ |
|     | 4A          | MTS06-3004B | MTS06-3004C | MTS06-3004D | 4  | 80       | 18,99 \$ |
|     | 5A          | MTS06-3005B | MTS06-3005C | MTS06-3005D | 4  | 80       | 19,00 \$ |
|     | 6A          | MTS06-3006B | MTS06-3006C | MTS06-3006D | 4  | 80       | 15,73 \$ |
|     | 10A         | MTS06-3010B | MTS06-3010C | MTS06-3010D | 4  | 80       | 15,74 \$ |
|     | 16A         | MTS06-3016B | MTS06-3016C | MTS06-3016D | 4  | 80       | 15,74 \$ |
|     | 20A         | MTS06-3020B | MTS06-3020C | MTS06-3020D | 4  | 80       | 15,74 \$ |
|     | 25A         | MTS06-3025B | MTS06-3025C | MTS06-3025D | 4  | 80       | 15,96 \$ |
|     | 32A         | MTS06-3032B | MTS06-3032C | MTS06-3032D | 4  | 80       | 18,46 \$ |
|     | 40A         | MTS06-3040B | MTS06-3040C | MTS06-3040D | 4  | 80       | 18,46 \$ |
|     | 50A         | MTS06-3050B | MTS06-3050C | MTS06-3050D | 4  | 80       | 18,85 \$ |
| 63A | MTS06-3063B | MTS06-3063C | MTS06-3063D | 4           | 80 | 21,15 \$ |          |



|     |             |             |             |             |    |          |          |
|-----|-------------|-------------|-------------|-------------|----|----------|----------|
| 4P  | 1A          | MTS06-4001B | MTS06-4001C | MTS06-4001D | 3  | 60       | 27,01 \$ |
|     | 2A          | MTS06-4002B | MTS06-4002C | MTS06-4002D | 3  | 60       | 27,01 \$ |
|     | 3A          | MTS06-4003B | MTS06-4003C | MTS06-4003D | 3  | 60       | 27,01 \$ |
|     | 4A          | MTS06-4004B | MTS06-4004C | MTS06-4004D | 3  | 60       | 27,01 \$ |
|     | 5A          | MTS06-4005B | MTS06-4005C | MTS06-4005D | 3  | 60       | 28,46 \$ |
|     | 6A          | MTS06-4006B | MTS06-4006C | MTS06-4006D | 3  | 60       | 25,17 \$ |
|     | 10A         | MTS06-4010B | MTS06-4010C | MTS06-4010D | 3  | 60       | 22,46 \$ |
|     | 16A         | MTS06-4016B | MTS06-4016C | MTS06-4016D | 3  | 60       | 22,46 \$ |
|     | 20A         | MTS06-4020B | MTS06-4020C | MTS06-4020D | 3  | 60       | 22,46 \$ |
|     | 25A         | MTS06-4025B | MTS06-4025C | MTS06-4025D | 3  | 60       | 22,46 \$ |
|     | 32A         | MTS06-4032B | MTS06-4032C | MTS06-4032D | 3  | 60       | 25,93 \$ |
|     | 40A         | MTS06-4040B | MTS06-4040C | MTS06-4040D | 3  | 60       | 27,01 \$ |
|     | 50A         | MTS06-4050B | MTS06-4050C | MTS06-4050D | 3  | 60       | 29,07 \$ |
| 63A | MTS06-4063B | MTS06-4063C | MTS06-4063D | 3           | 60 | 31,79 \$ |          |

## B - C TİPİ OTOMATİK SİGORTALAR - 10kA (MCB)



### MTS-10 SERİSİ

| Kutup Sayısı | In (A)<br>Anma Akımı | B Tipi<br>Ürün Kodu | C Tipi<br>Ürün Kodu | Kutu<br>Adedi | Koli<br>Adedi | Fiyat<br>(\$) |
|--------------|----------------------|---------------------|---------------------|---------------|---------------|---------------|
| 1P           | 1A                   | MTS10-1001B         | MTS10-1001C         | 12            | 240           | 10,58 \$      |
|              | 2A                   | MTS10-1002B         | MTS10-1002C         | 12            | 240           | 10,58 \$      |
|              | 3A                   | MTS10-1003B         | MTS10-1003C         | 12            | 240           | 10,58 \$      |
|              | 4A                   | MTS10-1004B         | MTS10-1004C         | 12            | 240           | 10,58 \$      |
|              | 5A                   | MTS10-1005B         | MTS10-1005C         | 12            | 240           | 10,58 \$      |
|              | 6A                   | MTS10-1006B         | MTS10-1006C         | 12            | 240           | 8,99 \$       |
|              | 10A                  | MTS10-1010B         | MTS10-1010C         | 12            | 240           | 8,08 \$       |
|              | 16A                  | MTS10-1016B         | MTS10-1016C         | 12            | 240           | 8,08 \$       |
|              | 20A                  | MTS10-1020B         | MTS10-1020C         | 12            | 240           | 8,08 \$       |
|              | 25A                  | MTS10-1025B         | MTS10-1025C         | 12            | 240           | 8,08 \$       |
|              | 32A                  | MTS10-1032B         | MTS10-1032C         | 12            | 240           | 8,65 \$       |
|              | 40A                  | MTS10-1040B         | MTS10-1040C         | 12            | 240           | 9,98 \$       |
|              | 50A                  | MTS10-1050B         | MTS10-1050C         | 12            | 240           | 10,58 \$      |
|              | 63A                  | MTS10-1063B         | MTS10-1063C         | 12            | 240           | 12,12 \$      |
| 80A          | MTS10-1080B          | MTS10-1080C         | 12                  | 240           | 21,24 \$      |               |
| 100A         | MTS10-1100B          | MTS10-1100C         | 12                  | 240           | 21,97 \$      |               |
| 125A         | MTS10-1125B          | MTS10-1125C         | 12                  | 240           | 25,19 \$      |               |
| 2P           | 1A                   | MTS10-2001B         | MTS10-2001C         | 6             | 120           | 25,00 \$      |
|              | 2A                   | MTS10-2002B         | MTS10-2002C         | 6             | 120           | 25,00 \$      |
|              | 3A                   | MTS10-2003B         | MTS10-2003C         | 6             | 120           | 25,00 \$      |
|              | 4A                   | MTS10-2004B         | MTS10-2004C         | 6             | 120           | 25,00 \$      |
|              | 5A                   | MTS10-2005B         | MTS10-2005C         | 6             | 120           | 25,00 \$      |
|              | 6A                   | MTS10-2006B         | MTS10-2006C         | 6             | 120           | 24,23 \$      |
|              | 10A                  | MTS10-2010B         | MTS10-2010C         | 6             | 120           | 22,78 \$      |
|              | 16A                  | MTS10-2016B         | MTS10-2016C         | 6             | 120           | 22,78 \$      |
|              | 20A                  | MTS10-2020B         | MTS10-2020C         | 6             | 120           | 22,78 \$      |
|              | 25A                  | MTS10-2025B         | MTS10-2025C         | 6             | 120           | 22,78 \$      |
|              | 32A                  | MTS10-2032B         | MTS10-2032C         | 6             | 120           | 26,35 \$      |
|              | 40A                  | MTS10-2040B         | MTS10-2040C         | 6             | 120           | 27,34 \$      |
|              | 50A                  | MTS10-2050B         | MTS10-2050C         | 6             | 120           | 28,08 \$      |
|              | 63A                  | MTS10-2063B         | MTS10-2063C         | 6             | 120           | 28,85 \$      |
| 80A          | MTS10-2080B          | MTS10-2080C         | 6                   | 120           | 39,15 \$      |               |
| 100A         | MTS10-2100B          | MTS10-2100C         | 6                   | 120           | 42,25 \$      |               |
| 125A         | MTS10-2125B          | MTS10-2125C         | 6                   | 120           | 46,93 \$      |               |
| 3P           | 1A                   | MTS10-3001B         | MTS10-3001C         | 4             | 80            | 36,54 \$      |
|              | 2A                   | MTS10-3002B         | MTS10-3002C         | 4             | 80            | 36,54 \$      |
|              | 3A                   | MTS10-3003B         | MTS10-3003C         | 4             | 80            | 36,54 \$      |
|              | 4A                   | MTS10-3004B         | MTS10-3004C         | 4             | 80            | 36,54 \$      |
|              | 5A                   | MTS10-3005B         | MTS10-3005C         | 4             | 80            | 36,54 \$      |
|              | 6A                   | MTS10-3006B         | MTS10-3006C         | 4             | 80            | 29,72 \$      |
|              | 10A                  | MTS10-3010B         | MTS10-3010C         | 4             | 80            | 27,55 \$      |
|              | 16A                  | MTS10-3016B         | MTS10-3016C         | 4             | 80            | 27,55 \$      |
|              | 20A                  | MTS10-3020B         | MTS10-3020C         | 4             | 80            | 27,55 \$      |
|              | 25A                  | MTS10-3025B         | MTS10-3025C         | 4             | 80            | 28,85 \$      |
|              | 32A                  | MTS10-3032B         | MTS10-3032C         | 4             | 80            | 29,42 \$      |
|              | 40A                  | MTS10-3040B         | MTS10-3040C         | 4             | 80            | 31,54 \$      |
|              | 50A                  | MTS10-3050B         | MTS10-3050C         | 4             | 80            | 35,58 \$      |
|              | 63A                  | MTS10-3063B         | MTS10-3063C         | 4             | 80            | 40,38 \$      |
| 80A          | MTS10-3080B          | MTS10-3080C         | 6                   | 120           | 74,83 \$      |               |
| 100A         | MTS10-3100B          | MTS10-3100C         | 6                   | 120           | 77,08 \$      |               |
| 125A         | MTS10-3125B          | MTS10-3125C         | 6                   | 120           | 83,97 \$      |               |
| 4P           | 1A                   | MTS10-4001B         | MTS10-4001C         | 3             | 60            | 51,10 \$      |
|              | 2A                   | MTS10-4002B         | MTS10-4002C         | 3             | 60            | 51,10 \$      |
|              | 3A                   | MTS10-4003B         | MTS10-4003C         | 3             | 60            | 51,10 \$      |
|              | 4A                   | MTS10-4004B         | MTS10-4004C         | 3             | 60            | 51,10 \$      |
|              | 5A                   | MTS10-4005B         | MTS10-4005C         | 3             | 60            | 51,12 \$      |
|              | 6A                   | MTS10-4006B         | MTS10-4006C         | 3             | 60            | 41,33 \$      |
|              | 10A                  | MTS10-4010B         | MTS10-4010C         | 3             | 60            | 38,22 \$      |
|              | 16A                  | MTS10-4016B         | MTS10-4016C         | 3             | 60            | 38,22 \$      |
|              | 20A                  | MTS10-4020B         | MTS10-4020C         | 3             | 60            | 38,22 \$      |
|              | 25A                  | MTS10-4025B         | MTS10-4025C         | 3             | 60            | 38,22 \$      |
|              | 32A                  | MTS10-4032B         | MTS10-4032C         | 3             | 60            | 38,33 \$      |
|              | 40A                  | MTS10-4040B         | MTS10-4040C         | 3             | 60            | 38,33 \$      |
|              | 50A                  | MTS10-4050B         | MTS10-4050C         | 3             | 60            | 50,00 \$      |
|              | 63A                  | MTS10-4063B         | MTS10-4063C         | 3             | 60            | 53,85 \$      |
| 80A          | MTS10-4080B          | MTS10-4080C         | 4                   | 80            | 102,04 \$     |               |
| 100A         | MTS10-4100B          | MTS10-4100C         | 4                   | 80            | 105,52 \$     |               |
| 125A         | MTS10-4125B          | MTS10-4125C         | 4                   | 80            | 118,46 \$     |               |





## B - C TİPİ OTOMATİK SİGORTALAR - 10kA (MCB) - GENİŞ KASA

### MTH SERİSİ

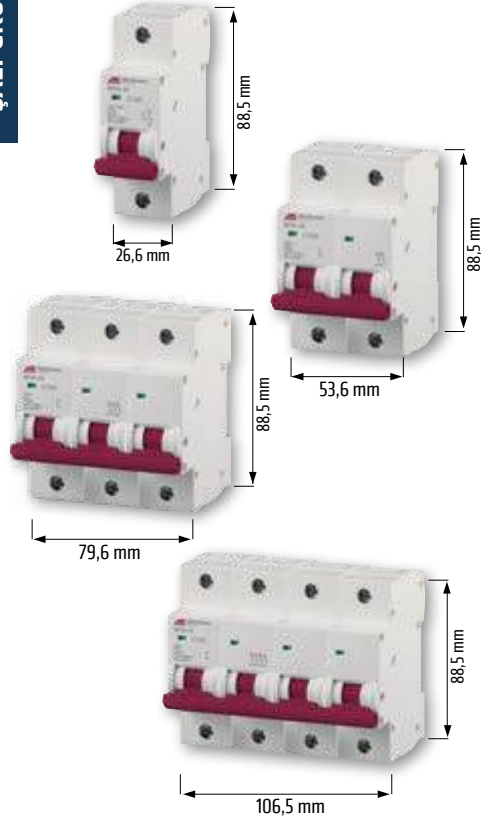

| Kutup Sayısı | In (A)<br>Anma Akımı | B Tipi<br>Ürün Kodu | C Tipi<br>Ürün Kodu | Kutu<br>Adedi | Koli<br>Adedi | Fiyat<br>(\$) |
|--------------|----------------------|---------------------|---------------------|---------------|---------------|---------------|
| 1P           | 80A                  | MTH10-1080B         | MTH10-1080C         | 12            | 120           | 23,85 \$      |
|              | 100A                 | MTH10-1100B         | MTH10-1100C         | 12            | 120           | 26,92 \$      |
|              | 125A                 | MTH10-1125B         | MTH10-1125C         | 12            | 120           | 28,85 \$      |
| 2P           | 80A                  | MTH10-2080B         | MTH10-2080C         | 6             | 60            | 44,23 \$      |
|              | 100A                 | MTH10-2100B         | MTH10-2100C         | 6             | 60            | 46,15 \$      |
|              | 125A                 | MTH10-2125B         | MTH10-2125C         | 6             | 60            | 53,85 \$      |
| 3P           | 80A                  | MTH10-3080B         | MTH10-3080C         | 4             | 40            | 76,15 \$      |
|              | 100A                 | MTH10-3100B         | MTH10-3100C         | 4             | 40            | 80,00 \$      |
|              | 125A                 | MTH10-3125B         | MTH10-3125C         | 4             | 40            | 88,46 \$      |
| 4P           | 80A                  | MTH10-4080B         | MTH10-4080C         | 3             | 30            | 98,08 \$      |
|              | 100A                 | MTH10-4100B         | MTH10-4100C         | 3             | 30            | 103,85 \$     |
|              | 125A                 | MTH10-4125B         | MTH10-4125C         | 3             | 30            | 130,77 \$     |

## OTOMATİK SİGORTA AKSESUARLARI

| Ürün Kodu   | Ürün Adı  | Kutu<br>Adedi | Fiyat<br>(\$) |
|-------------|---|---------------|---------------|
| MTSAUX-AC12 | Yardımcı Kontakt 1NO+1NC (MTS06 ve MTS10 için)                | 1             | 11,92 \$      |
| MTSAUX-230  | Açtırma Bobini 230V AC (MTS06 ve MTS10 için)                  | 1             | 17,69 \$      |
| MTSAUX-063  | Alarm Kontakt (MTS06 ve MTS10 için)                           | 1             | 11,92 \$      |
| MTSACC-SL1  | Emniyet Kilit Aparatı (MTS serileri için)                     | 1             | 30,77 \$      |
| MTSACC-SL2  | Emniyet Kilit Aparatı (MRC ve MTH (Geniş kasa) serileri için) | 1             | 30,77 \$      |



## FAZ+NÖTR SİGORTALAR - 4,5kA (DPN+MCB)

### MTS04-LN SERİSİ



| Kutup Sayısı | In (A)<br>Anma Akımı | Ürün Kodu   | Kutu<br>Adedi | Koli<br>Adedi | Fiyat<br>(\$) |
|--------------|----------------------|-------------|---------------|---------------|---------------|
| 1P+N         | 6A                   | MTS04-106CN | 12            | 240           | 7,62 \$       |
|              | 10A                  | MTS04-110CN | 12            | 240           | 7,62 \$       |
|              | 16A                  | MTS04-116CN | 12            | 240           | 7,62 \$       |
|              | 20A                  | MTS04-120CN | 12            | 240           | 7,62 \$       |
|              | 25A                  | MTS04-125CN | 12            | 240           | 7,62 \$       |
|              | 32A                  | MTS04-132CN | 12            | 240           | 8,38 \$       |
|              | 40A                  | MTS04-140CN | 12            | 240           | 8,38 \$       |

| MTS                     | Kiloamper<br>(kA) | Kutup<br>Sayısı | Amper<br>(A)   | Tip<br>(Eğri) | Nötr |
|-------------------------|-------------------|-----------------|----------------|---------------|------|
| Faz + Nötr<br>Seri Kodu | 04                | 1               | XX<br>6A...40A | C             | N    |

|                               |                       |                     |                       |                  |                         |
|-------------------------------|-----------------------|---------------------|-----------------------|------------------|-------------------------|
| <b>MRC</b>                    | <b>Kiloamper (kA)</b> | <b>Kutup Sayısı</b> | <b>Miliamper (mA)</b> | <b>Amper (A)</b> | <b>Tip</b>              |
| Kaçak Akım Koruma Serisi Kodu | 06/10                 | 2/4                 | 030/300               | XXX<br>1A...100A | A / A tipi<br>/ AC tipi |

## KAÇAK AKIM DEVRE KORUMA 6kA / AC TİPİ (RCCB)



### MRC-2 / MRC-4 SERİSİ

| Kutup Sayısı | In (A)<br>Anma Akımı | mA            | AC Tipi<br>Ürün Kodu | Kutu Adedi   | Koli Adedi | Fiyat (\$) |
|--------------|----------------------|---------------|----------------------|--------------|------------|------------|
| 2P           | 16A                  | 10 mA         | MRC06-201016         | 1            | 100        | 36,93 \$   |
|              | 25A                  |               | MRC06-201025         | 1            | 100        | 37,66 \$   |
|              | 16A                  |               | 30 mA                | MRC06-203016 | 1          | 100        |
|              | 20A                  | MRC06-203020  |                      | 1            | 100        | 33,08 \$   |
|              | 25A                  | MRC06-203025  |                      | 1            | 100        | 33,08 \$   |
|              | 32A                  | MRC06-203032  |                      | 1            | 100        | 33,08 \$   |
|              | 40A                  | MRC06-203040  |                      | 1            | 100        | 33,08 \$   |
|              | 50A                  | MRC06-203050  |                      | 1            | 100        | 34,62 \$   |
|              | 63A                  | MRC06-203063  |                      | 1            | 100        | 36,45 \$   |
|              | 80A                  | MRC06-203080  |                      | 1            | 100        | 49,46 \$   |
|              | 100A                 | MRC06-2030100 |                      | 1            | 100        | 59,66 \$   |
|              | 16A                  | 100 mA        | MRC06-210016         | 1            | 100        | 33,74 \$   |
|              | 20A                  |               | MRC06-210020         | 1            | 100        | 33,74 \$   |
|              | 25A                  |               | MRC06-210025         | 1            | 100        | 33,74 \$   |
|              | 32A                  |               | MRC06-210032         | 1            | 100        | 33,74 \$   |
|              | 40A                  |               | MRC06-210040         | 1            | 100        | 33,74 \$   |
|              | 50A                  |               | MRC06-210050         | 1            | 100        | 33,74 \$   |
|              | 63A                  |               | MRC06-210063         | 1            | 100        | 33,74 \$   |
|              | 80A                  |               | MRC06-210080         | 1            | 100        | 48,92 \$   |
|              | 100A                 |               | MRC06-2100100        | 1            | 100        | 54,59 \$   |
|              | 16A                  | 300 mA        | MRC06-230016         | 1            | 100        | 33,74 \$   |
|              | 20A                  |               | MRC06-230020         | 1            | 100        | 33,74 \$   |
|              | 25A                  |               | MRC06-230025         | 1            | 100        | 31,92 \$   |
|              | 32A                  |               | MRC06-230032         | 1            | 100        | 31,92 \$   |
|              | 40A                  |               | MRC06-230040         | 1            | 100        | 31,92 \$   |
|              | 50A                  |               | MRC06-230050         | 1            | 100        | 31,92 \$   |
|              | 63A                  |               | MRC06-230063         | 1            | 100        | 36,24 \$   |
|              | 80A                  |               | MRC06-230080         | 1            | 100        | 48,92 \$   |
|              | 100A                 |               | MRC06-2300100        | 1            | 100        | 54,57 \$   |
|              | 4P                   | 16A           | 30 mA                | MRC06-403016 | 1          | 50         |
| 20A          |                      | MRC06-403020  |                      | 1            | 50         | 48,08 \$   |
| 25A          |                      | MRC06-403025  |                      | 1            | 50         | 48,08 \$   |
| 32A          |                      | MRC06-403032  |                      | 1            | 50         | 48,08 \$   |
| 40A          |                      | MRC06-403040  |                      | 1            | 50         | 48,08 \$   |
| 50A          |                      | MRC06-403050  |                      | 1            | 50         | 49,56 \$   |
| 63A          |                      | MRC06-403063  |                      | 1            | 50         | 50,77 \$   |
| 80A          |                      | MRC06-403080  |                      | 1            | 50         | 70,22 \$   |
| 100A         |                      | MRC06-4030100 |                      | 1            | 50         | 70,22 \$   |
| 16A          |                      | 100 mA        | MRC06-410016         | 1            | 50         | 49,56 \$   |
| 20A          |                      |               | MRC06-410020         | 1            | 50         | 49,56 \$   |
| 25A          |                      |               | MRC06-410025         | 1            | 50         | 49,56 \$   |
| 32A          |                      |               | MRC06-410032         | 1            | 50         | 49,56 \$   |
| 40A          |                      |               | MRC06-410040         | 1            | 50         | 49,56 \$   |
| 50A          |                      |               | MRC06-410050         | 1            | 50         | 49,56 \$   |
| 63A          |                      |               | MRC06-410063         | 1            | 50         | 49,56 \$   |
| 80A          |                      |               | MRC06-410080         | 1            | 50         | 64,56 \$   |
| 100A         |                      |               | MRC06-4100100        | 1            | 50         | 69,27 \$   |
| 16A          |                      | 300 mA        | MRC06-430016         | 1            | 50         | 49,56 \$   |
| 20A          |                      |               | MRC06-430020         | 1            | 50         | 49,56 \$   |
| 25A          |                      |               | MRC06-430025         | 1            | 50         | 49,58 \$   |
| 32A          |                      |               | MRC06-430032         | 1            | 50         | 49,58 \$   |
| 40A          |                      |               | MRC06-430040         | 1            | 50         | 49,58 \$   |
| 50A          |                      |               | MRC06-430050         | 1            | 50         | 49,58 \$   |
| 63A          |                      |               | MRC06-430063         | 1            | 50         | 50,00 \$   |
| 80A          |                      |               | MRC06-430080         | 1            | 50         | 70,72 \$   |
| 100A         |                      |               | MRC06-4300100        | 1            | 50         | 79,52 \$   |



## CE KAÇAK AKIM DEVRE KORUMA 10kA / AC TİPİ (RCCB)

### MRC-2-10 / MRC-4 -10 SERİSİ



| Kutup Sayısı | In (A)<br>Anma Akımı | mA            | AC Tipi<br>Ürün Kodu | Kutu Adedi   | Koli Adedi | Fiyat (\$) |          |
|--------------|----------------------|---------------|----------------------|--------------|------------|------------|----------|
| 2P           | 16A                  | 30<br>mA      | MRC10-203016         | 1            | 100        | 39,62 \$   |          |
|              | 20A                  |               | MRC10-203020         | 1            | 100        | 39,62 \$   |          |
|              | 25A                  |               | MRC10-203025         | 1            | 100        | 39,62 \$   |          |
|              | 32A                  |               | MRC10-203032         | 1            | 100        | 39,62 \$   |          |
|              | 40A                  |               | MRC10-203040         | 1            | 100        | 39,62 \$   |          |
|              | 50A                  |               | MRC10-203050         | 1            | 100        | 42,31 \$   |          |
|              | 63A                  |               | MRC10-203063         | 1            | 100        | 42,31 \$   |          |
|              | 80A                  |               | MRC10-203080         | 1            | 100        | 64,69 \$   |          |
|              | 100A                 |               | MRC10-2030100        | 1            | 100        | 64,69 \$   |          |
|              | 125A                 |               | MRC10-2030125        | 1            | 50         | 76,92 \$   |          |
|              | 16A                  | 300<br>mA     | MRC10-230016         | 1            | 100        | 39,62 \$   |          |
|              | 20A                  |               | MRC10-230020         | 1            | 100        | 39,62 \$   |          |
|              | 25A                  |               | MRC10-230025         | 1            | 100        | 39,62 \$   |          |
|              | 32A                  |               | MRC10-230032         | 1            | 100        | 39,62 \$   |          |
|              | 40A                  |               | MRC10-230040         | 1            | 100        | 39,62 \$   |          |
|              | 50A                  |               | MRC10-230050         | 1            | 100        | 42,31 \$   |          |
|              | 63A                  |               | MRC10-230063         | 1            | 100        | 42,31 \$   |          |
|              | 80A                  |               | MRC10-230080         | 1            | 100        | 64,69 \$   |          |
|              | 100A                 |               | MRC10-2300100        | 1            | 100        | 64,69 \$   |          |
|              | 125A                 |               | MRC10-2300125        | 1            | 50         | 76,92 \$   |          |
|              | 4P                   | 16A           | 30<br>mA             | MRC10-403016 | 1          | 50         | 67,31 \$ |
|              |                      | 20A           |                      | MRC10-403020 | 1          | 50         | 67,31 \$ |
|              |                      | 25A           |                      | MRC10-403025 | 1          | 50         | 67,31 \$ |
|              |                      | 32A           |                      | MRC10-403032 | 1          | 50         | 67,31 \$ |
| 40A          |                      | MRC10-403040  |                      | 1            | 50         | 67,31 \$   |          |
| 50A          |                      | MRC10-403050  |                      | 1            | 50         | 67,31 \$   |          |
| 63A          |                      | MRC10-403063  |                      | 1            | 50         | 67,31 \$   |          |
| 80A          |                      | MRC10-403080  |                      | 1            | 50         | 88,87 \$   |          |
| 100A         |                      | MRC10-4030100 |                      | 1            | 50         | 88,87 \$   |          |
| 125A         |                      | MRC10-4030125 |                      | 1            | 50         | 100,00 \$  |          |
| 16A          |                      | 300<br>mA     | MRC10-430016         | 1            | 50         | 67,34 \$   |          |
| 20A          |                      |               | MRC10-430020         | 1            | 50         | 67,34 \$   |          |
| 25A          |                      |               | MRC10-430025         | 1            | 50         | 67,34 \$   |          |
| 32A          |                      |               | MRC10-430032         | 1            | 50         | 67,34 \$   |          |
| 40A          |                      |               | MRC10-430040         | 1            | 50         | 67,34 \$   |          |
| 50A          |                      |               | MRC10-430050         | 1            | 50         | 67,34 \$   |          |
| 63A          |                      |               | MRC10-430063         | 1            | 50         | 67,34 \$   |          |
| 80A          |                      |               | MRC10-430080         | 1            | 50         | 88,87 \$   |          |
| 100A         |                      |               | MRC10-4300100        | 1            | 50         | 88,87 \$   |          |
| 125A         |                      |               | MRC10-4300125        | 1            | 50         | 100,00 \$  |          |



## KAÇAK AKIM DEVRE KORUMA 6kA / A TİPİ (RCCB)

CE

MRC-2 / MRC-4 SERİSİ

| Kutup Sayısı | In (A)<br>Anma Akımı | mA        | A Tipi<br>Ürün Kodu | Kutu<br>Adedi | Koli<br>Adedi | Fiyat<br>(\$) |
|--------------|----------------------|-----------|---------------------|---------------|---------------|---------------|
| 2P           | 16A                  | 30<br>mA  | MRC06-203016A       | 1             | 100           | 50,48 \$      |
|              | 20A                  |           | MRC06-203020A       | 1             | 100           | 50,48 \$      |
|              | 25A                  |           | MRC06-203025A       | 1             | 100           | 50,48 \$      |
|              | 32A                  |           | MRC06-203032A       | 1             | 100           | 50,48 \$      |
|              | 40A                  |           | MRC06-203040A       | 1             | 100           | 50,48 \$      |
|              | 50A                  |           | MRC06-203050A       | 1             | 100           | 50,48 \$      |
|              | 63A                  |           | MRC06-203063A       | 1             | 100           | 50,48 \$      |
|              | 80A                  |           | MRC06-203080A       | 1             | 100           | 86,59 \$      |
|              | 100A                 |           | MRC06-2030100A      | 1             | 100           | 86,59 \$      |
|              | 16A                  | 300<br>mA | MRC06-230016A       | 1             | 100           | 50,48 \$      |
|              | 20A                  |           | MRC06-230020A       | 1             | 100           | 50,48 \$      |
|              | 25A                  |           | MRC06-230025A       | 1             | 100           | 50,48 \$      |
|              | 32A                  |           | MRC06-230032A       | 1             | 100           | 50,48 \$      |
|              | 40A                  |           | MRC06-230040A       | 1             | 100           | 50,48 \$      |
|              | 50A                  |           | MRC06-230050A       | 1             | 100           | 50,48 \$      |
|              | 63A                  |           | MRC06-230063A       | 1             | 100           | 50,48 \$      |
|              | 80A                  |           | MRC06-230080A       | 1             | 100           | 65,84 \$      |
|              | 100A                 |           | MRC06-2300100A      | 1             | 100           | 65,84 \$      |
| 4P           | 16A                  | 30<br>mA  | MRC06-403016A       | 1             | 50            | 64,46 \$      |
|              | 20A                  |           | MRC06-403020A       | 1             | 50            | 64,46 \$      |
|              | 25A                  |           | MRC06-403025A       | 1             | 50            | 64,46 \$      |
|              | 32A                  |           | MRC06-403032A       | 1             | 50            | 64,46 \$      |
|              | 40A                  |           | MRC06-403040A       | 1             | 50            | 64,46 \$      |
|              | 50A                  |           | MRC06-403050A       | 1             | 50            | 64,46 \$      |
|              | 63A                  |           | MRC06-403063A       | 1             | 50            | 64,46 \$      |
|              | 80A                  |           | MRC06-403080A       | 1             | 50            | 102,87 \$     |
|              | 100A                 |           | MRC06-4030100A      | 1             | 50            | 102,87 \$     |
|              | 16A                  | 300<br>mA | MRC06-430016A       | 1             | 50            | 64,46 \$      |
|              | 20A                  |           | MRC06-430020A       | 1             | 50            | 64,46 \$      |
|              | 25A                  |           | MRC06-430025A       | 1             | 50            | 64,46 \$      |
|              | 32A                  |           | MRC06-430032A       | 1             | 50            | 64,46 \$      |
|              | 40A                  |           | MRC06-430040A       | 1             | 50            | 64,46 \$      |
|              | 50A                  |           | MRC06-430050A       | 1             | 50            | 64,46 \$      |
|              | 63A                  |           | MRC06-430063A       | 1             | 50            | 64,46 \$      |
|              | 80A                  |           | MRC06-430080A       | 1             | 50            | 88,46 \$      |
|              | 100A                 |           | MRC06-4300100A      | 1             | 50            | 88,46 \$      |



## CE KAÇAK AKIM DEVRE KORUMA 10kA / A TİPİ (RCCB)

### MRC-2-10 / MRC-4 -10 SERİSİ



| Kutup Sayısı | In (A)<br>Anma Akımı | mA             | A Tipi<br>Ürün Kodu | Kutu<br>Adedi | Koli<br>Adedi | Fiyat<br>(\$) |
|--------------|----------------------|----------------|---------------------|---------------|---------------|---------------|
| 2P           | 16A                  | 30<br>mA       | MRC10-203016A       | 1             | 100           | 58,52 \$      |
|              | 20A                  |                | MRC10-203020A       | 1             | 100           | 58,52 \$      |
|              | 25A                  |                | MRC10-203025A       | 1             | 100           | 58,52 \$      |
|              | 32A                  |                | MRC10-203032A       | 1             | 100           | 58,52 \$      |
|              | 40A                  |                | MRC10-203040A       | 1             | 100           | 58,52 \$      |
|              | 50A                  |                | MRC10-203050A       | 1             | 100           | 58,52 \$      |
|              | 63A                  |                | MRC10-203063A       | 1             | 100           | 58,52 \$      |
|              | 80A                  |                | MRC10-203080A       | 1             | 100           | 94,55 \$      |
|              | 100A                 |                | MRC10-2030100A      | 1             | 100           | 94,55 \$      |
|              | 125A                 | MRC10-2030125A | 1                   | 100           | 103,85 \$     |               |
|              | 16A                  | 300<br>mA      | MRC10-230016A       | 1             | 100           | 58,52 \$      |
|              | 20A                  |                | MRC10-230020A       | 1             | 100           | 58,52 \$      |
|              | 25A                  |                | MRC10-230025A       | 1             | 100           | 58,52 \$      |
|              | 32A                  |                | MRC10-230032A       | 1             | 100           | 58,52 \$      |
|              | 40A                  |                | MRC10-230040A       | 1             | 100           | 58,52 \$      |
|              | 50A                  |                | MRC10-230050A       | 1             | 100           | 58,52 \$      |
|              | 63A                  |                | MRC10-230063A       | 1             | 100           | 58,52 \$      |
|              | 80A                  |                | MRC10-230080A       | 1             | 100           | 94,54 \$      |
| 100A         | MRC10-2300100A       |                | 1                   | 100           | 94,54 \$      |               |
| 125A         | MRC10-2300125A       | 1              | 100                 | 103,85 \$     |               |               |
| 4P           | 16A                  | 30<br>mA       | MRC10-403016A       | 1             | 50            | 80,10 \$      |
|              | 20A                  |                | MRC10-403020A       | 1             | 50            | 80,10 \$      |
|              | 25A                  |                | MRC10-403025A       | 1             | 50            | 80,10 \$      |
|              | 32A                  |                | MRC10-403032A       | 1             | 50            | 80,10 \$      |
|              | 40A                  |                | MRC10-403040A       | 1             | 50            | 80,10 \$      |
|              | 50A                  |                | MRC10-403050A       | 1             | 50            | 80,10 \$      |
|              | 63A                  |                | MRC10-403063A       | 1             | 50            | 80,10 \$      |
|              | 80A                  |                | MRC10-403080A       | 1             | 50            | 118,78 \$     |
|              | 100A                 |                | MRC10-4030100A      | 1             | 50            | 118,78 \$     |
|              | 125A                 | MRC10-4030125A | 1                   | 50            | 126,92 \$     |               |
|              | 16A                  | 300<br>mA      | MRC10-430016A       | 1             | 50            | 80,10 \$      |
|              | 20A                  |                | MRC10-430020A       | 1             | 50            | 80,10 \$      |
|              | 25A                  |                | MRC10-430025A       | 1             | 50            | 80,10 \$      |
|              | 32A                  |                | MRC10-430032A       | 1             | 50            | 80,10 \$      |
|              | 40A                  |                | MRC10-430040A       | 1             | 50            | 80,10 \$      |
|              | 50A                  |                | MRC10-430050A       | 1             | 50            | 80,10 \$      |
|              | 63A                  |                | MRC10-430063A       | 1             | 50            | 80,10 \$      |
|              | 80A                  |                | MRC10-430080A       | 1             | 50            | 118,77 \$     |
| 100A         | MRC10-4300100A       |                | 1                   | 50            | 118,77 \$     |               |
| 125A         | MRC10-4300125A       | 1              | 50                  | 126,92 \$     |               |               |



## KAÇAK AKIM DEVRE KORUMA - 10kA / B TİPİ (RCCB)

| Kutup Sayısı | In (A)<br>Anma Akımı | mA     | Ürün Kodu     | Kutu Adedi | Koli Adedi | Fiyat (\$) |
|--------------|----------------------|--------|---------------|------------|------------|------------|
| 2P           | 25A                  | 30 mA  | MRC10-203025B | 1          | 100        | 187,09 \$  |
|              | 40A                  |        | MRC10-203040B | 1          | 100        | 187,09 \$  |
|              | 63A                  |        | MRC10-203063B | 1          | 100        | 187,09 \$  |
|              | 25A                  | 300 mA | MRC10-230025B | 1          | 100        | 187,09 \$  |
|              | 40A                  |        | MRC10-230040B | 1          | 100        | 187,09 \$  |
|              | 63A                  |        | MRC10-230063B | 1          | 100        | 187,09 \$  |
| 4P           | 25A                  | 30 mA  | MRC10-403025B | 1          | 50         | 320,78 \$  |
|              | 40A                  |        | MRC10-403040B | 1          | 50         | 320,78 \$  |
|              | 63A                  |        | MRC10-403063B | 1          | 50         | 320,78 \$  |
|              | 25A                  | 300 mA | MRC10-430025B | 1          | 50         | 320,78 \$  |
|              | 40A                  |        | MRC10-430040B | 1          | 50         | 320,78 \$  |
|              | 63A                  |        | MRC10-430063B | 1          | 50         | 320,78 \$  |



### MRC-2B / MRC-4B SERİSİ



## KAÇAK AKIM DEVRE KORUMA - GECİKMELİ - 6kA

| Kutup Sayısı | In (A)<br>Anma Akımı | mA     | Ürün Tipi | Kutu Adedi      | Kutu Adedi | Koli Adedi | Fiyat (\$) |
|--------------|----------------------|--------|-----------|-----------------|------------|------------|------------|
| 2P           | 25A                  | 30 mA  | AC Tipi   | MRC06-203025G   | 1          | 100        | 64,36 \$   |
|              | 40A                  |        |           | MRC06-203040G   | 1          | 100        | 64,36 \$   |
|              | 63A                  |        |           | MRC06-203063G   | 1          | 100        | 64,36 \$   |
|              | 80A                  |        |           | MRC06-203080G   | 1          | 100        | 96,11 \$   |
|              | 100A                 |        |           | MRC06-2030100G  | 1          | 100        | 96,12 \$   |
|              | 25A                  | 30 mA  | A Tipi    | MRC06-203025AG  | 1          | 100        | 79,08 \$   |
|              | 40A                  |        |           | MRC06-203040AG  | 1          | 100        | 79,08 \$   |
|              | 63A                  |        |           | MRC06-203063AG  | 1          | 100        | 79,08 \$   |
|              | 80A                  |        |           | MRC06-203080AG  | 1          | 100        | 103,95 \$  |
|              | 100A                 |        |           | MRC06-2030100AG | 1          | 100        | 103,96 \$  |
|              | 25A                  | 300 mA | AC Tipi   | MRC06-230025G   | 1          | 100        | 64,36 \$   |
|              | 40A                  |        |           | MRC06-230040G   | 1          | 100        | 64,36 \$   |
|              | 63A                  |        |           | MRC06-230063G   | 1          | 100        | 64,36 \$   |
|              | 80A                  |        |           | MRC06-230080G   | 1          | 100        | 71,76 \$   |
|              | 100A                 |        |           | MRC06-2300100G  | 1          | 100        | 71,76 \$   |
|              | 25A                  | 300 mA | A Tipi    | MRC06-230025AG  | 1          | 100        | 79,08 \$   |
|              | 40A                  |        |           | MRC06-230040AG  | 1          | 100        | 79,08 \$   |
|              | 63A                  |        |           | MRC06-230063AG  | 1          | 100        | 79,08 \$   |
|              | 80A                  |        |           | MRC06-230080AG  | 1          | 100        | 86,39 \$   |
|              | 100A                 |        |           | MRC06-2300100AG | 1          | 100        | 86,39 \$   |
| 4P           | 25A                  | 30 mA  | AC Tipi   | MRC06-403025G   | 1          | 50         | 81,86 \$   |
|              | 40A                  |        |           | MRC06-403040G   | 1          | 50         | 81,86 \$   |
|              | 63A                  |        |           | MRC06-403063G   | 1          | 50         | 81,86 \$   |
|              | 80A                  |        |           | MRC06-403080G   | 1          | 50         | 94,89 \$   |
|              | 100A                 |        |           | MRC06-4030100G  | 1          | 50         | 94,89 \$   |
|              | 25A                  | 30 mA  | A Tipi    | MRC06-403025AG  | 1          | 50         | 96,84 \$   |
|              | 40A                  |        |           | MRC06-403040AG  | 1          | 50         | 96,84 \$   |
|              | 63A                  |        |           | MRC06-403063AG  | 1          | 50         | 96,84 \$   |
|              | 80A                  |        |           | MRC06-403080AG  | 1          | 50         | 122,28 \$  |
|              | 100A                 |        |           | MRC06-4030100AG | 1          | 50         | 122,28 \$  |
|              | 25A                  | 300 mA | AC Tipi   | MRC06-430025G   | 1          | 50         | 81,86 \$   |
|              | 40A                  |        |           | MRC06-430040G   | 1          | 50         | 81,86 \$   |
|              | 63A                  |        |           | MRC06-430063G   | 1          | 50         | 81,86 \$   |
|              | 80A                  |        |           | MRC06-430080G   | 1          | 50         | 89,26 \$   |
|              | 100A                 |        |           | MRC06-4300100G  | 1          | 50         | 89,26 \$   |
|              | 25A                  | 300 mA | A Tipi    | MRC06-430025AG  | 1          | 50         | 96,84 \$   |
|              | 40A                  |        |           | MRC06-430040AG  | 1          | 50         | 96,84 \$   |
|              | 63A                  |        |           | MRC06-430063AG  | 1          | 50         | 96,84 \$   |
|              | 80A                  |        |           | MRC06-430080AG  | 1          | 50         | 104,24 \$  |
|              | 100A                 |        |           | MRC06-4300100AG | 1          | 50         | 104,24 \$  |



### MRC-2G / MRC-4G SERİSİ

\* Gecikmeli tip kaçak akım devre korumalar, seçicilik sağlayarak alt devrelerin önce açmasını mümkün kılar.



## KAÇAK AKIM TEKRAR KAPATMA ÜNİTESİ - RECLOSER

| Ürün Kodu   | Ürün Adı                          | Kutu Adedi | Koli Adedi | Fiyat (\$) |
|-------------|-----------------------------------|------------|------------|------------|
| MRC06-RC300 | Kaçak Akım Tekrar Kapatma Ünitesi | 1          | 50         | 175,84 \$  |



## ARK HATASI ALGILAMA RÖLESİ (AFDD)

### MAFD SERİSİ



| Kutup Sayısı | In (A)<br>Anma Akımı | mA       | Tip           | Ürün Kodu        | Kutu Adedi | Koli Adedi | Fiyat (\$) |
|--------------|----------------------|----------|---------------|------------------|------------|------------|------------|
| 2P           | 6A                   | 30<br>mA | RCCB+AFDD-32  | MAFDR1C06-203006 | 1          | 100        | 211,05 \$  |
|              | 10A                  |          |               | MAFDR1C06-203010 | 1          | 100        | 211,05 \$  |
|              | 16A                  |          |               | MAFDR1C06-203016 | 1          | 100        | 211,05 \$  |
|              | 20A                  |          |               | MAFDR1C06-203020 | 1          | 100        | 211,05 \$  |
|              | 25A                  |          |               | MAFDR1C06-203025 | 1          | 100        | 211,05 \$  |
|              | 32A                  |          |               | MAFDR1C06-203032 | 1          | 100        | 211,05 \$  |
|              | 6A                   | 30<br>mA | RCBO+AFDD-32  | MAFDR1C06-203006 | 1          | 100        | 225,13 \$  |
|              | 10A                  |          |               | MAFDR1C06-203010 | 1          | 100        | 225,13 \$  |
|              | 16A                  |          |               | MAFDR1C06-203016 | 1          | 100        | 225,13 \$  |
|              | 20A                  |          |               | MAFDR1C06-203025 | 1          | 100        | 225,13 \$  |
|              | 25A                  |          |               | MAFDR1C06-203030 | 1          | 100        | 225,13 \$  |
|              | 32A                  |          |               | MAFDR1C06-203032 | 1          | 100        | 225,13 \$  |
|              | 6A                   | 30<br>mA | MCB + AFDD-32 | MAFDT1S06-2006   | 1          | 100        | 196,96 \$  |
|              | 10A                  |          |               | MAFDT1S06-2010   | 1          | 100        | 196,96 \$  |
|              | 16A                  |          |               | MAFDT1S06-2016   | 1          | 100        | 196,96 \$  |
|              | 20A                  |          |               | MAFDT1S06-2020   | 1          | 100        | 196,96 \$  |
|              | 25A                  |          |               | MAFDT1S06-2025   | 1          | 100        | 196,96 \$  |
|              | 32A                  |          |               | MAFDT1S06-2032   | 1          | 100        | 196,96 \$  |
| 2P           | 6A                   | 30<br>mA | RCCB+AFDD-63  | MAFDR2C06-203006 | 1          | 50         | 184,86 \$  |
|              | 10A                  |          |               | MAFDR2C06-203010 | 1          | 50         | 184,86 \$  |
|              | 16A                  |          |               | MAFDR2C06-203016 | 1          | 50         | 184,86 \$  |
|              | 20A                  |          |               | MAFDR2C06-203020 | 1          | 50         | 184,86 \$  |
|              | 25A                  |          |               | MAFDR2C06-203025 | 1          | 50         | 184,86 \$  |
|              | 32A                  |          |               | MAFDR2C06-203032 | 1          | 50         | 184,86 \$  |
|              | 40A                  |          |               | MAFDR2C06-203040 | 1          | 50         | 184,86 \$  |
|              | 50A                  |          |               | MAFDR2C06-203050 | 1          | 50         | 184,86 \$  |
|              | 63A                  |          |               | MAFDR2C06-203063 | 1          | 50         | 184,86 \$  |
|              | 6A                   | 30<br>mA | RCBO+AFDD-63  | MAFDR2C06-203006 | 1          | 50         | 184,86 \$  |
|              | 10A                  |          |               | MAFDR2C06-203010 | 1          | 50         | 184,86 \$  |
|              | 16A                  |          |               | MAFDR2C06-203016 | 1          | 50         | 184,86 \$  |
|              | 20A                  |          |               | MAFDR2C06-203025 | 1          | 50         | 184,86 \$  |
|              | 25A                  |          |               | MAFDR2C06-203030 | 1          | 50         | 184,86 \$  |
|              | 32A                  |          |               | MAFDR2C06-203032 | 1          | 50         | 184,86 \$  |
|              | 40A                  |          |               | MAFDR2C06-203040 | 1          | 50         | 184,86 \$  |
|              | 50A                  |          |               | MAFDR2C06-203050 | 1          | 50         | 184,86 \$  |
|              | 63A                  |          |               | MAFDR2C06-203063 | 1          | 50         | 184,86 \$  |
| 2P           | 6A                   | 30<br>mA | MCB + AFDD-63 | MAFDT2S06-2006   | 1          | 50         | 172,75 \$  |
|              | 10A                  |          |               | MAFDT2S06-2010   | 1          | 50         | 172,75 \$  |
|              | 16A                  |          |               | MAFDT2S06-2016   | 1          | 50         | 172,75 \$  |
|              | 20A                  |          |               | MAFDT2S06-2020   | 1          | 50         | 172,75 \$  |
|              | 25A                  |          |               | MAFDT2S06-2025   | 1          | 50         | 172,75 \$  |
|              | 32A                  |          |               | MAFDT2S06-2032   | 1          | 50         | 172,75 \$  |
|              | 40A                  |          |               | MAFDT2S06-2040   | 1          | 50         | 172,75 \$  |
|              | 50A                  |          |               | MAFDT2S06-2050   | 1          | 50         | 172,75 \$  |
|              | 63A                  |          |               | MAFDT2S06-2063   | 1          | 50         | 172,75 \$  |

**MTSIS**
**Kutup  
Sayısı**
**Amper  
(A)**
**İzolatör / Yük Ayırıcı  
Seri Kodu**
**1 / 2 / 3 / 4**
**XXX  
32A...125A**

## İZOLATÖRLER - YÜK AYIRICILAR

**CE**

### MTSIS SERİSİ

| Kutup Sayısı | In (A)<br>Anma Akımı | Ürün Kodu  | Kutu Adedi | Koli Adedi | Fiyat (\$) |
|--------------|----------------------|------------|------------|------------|------------|
| 1P           | 32A                  | MTSIS-1032 | 12         | 240        | 7,31 \$    |
|              | 40A                  | MTSIS-1040 | 12         | 240        | 7,31 \$    |
|              | 63A                  | MTSIS-1063 | 12         | 240        | 7,31 \$    |
|              | 80A                  | MTSIS-1080 | 12         | 240        | 9,62 \$    |
|              | 100A                 | MTSIS-1100 | 12         | 240        | 9,62 \$    |
|              | 125A                 | MTSIS-1125 | 12         | 240        | 9,62 \$    |
| 2P           | 32A                  | MTSIS-2032 | 6          | 120        | 14,88 \$   |
|              | 40A                  | MTSIS-2040 | 6          | 120        | 14,88 \$   |
|              | 63A                  | MTSIS-2063 | 6          | 120        | 17,00 \$   |
|              | 80A                  | MTSIS-2080 | 6          | 120        | 17,00 \$   |
|              | 100A                 | MTSIS-2100 | 6          | 120        | 19,23 \$   |
|              | 125A                 | MTSIS-2125 | 6          | 120        | 19,23 \$   |
| 3P           | 32A                  | MTSIS-3032 | 4          | 80         | 19,23 \$   |
|              | 40A                  | MTSIS-3040 | 4          | 80         | 19,23 \$   |
|              | 63A                  | MTSIS-3063 | 4          | 80         | 21,53 \$   |
|              | 80A                  | MTSIS-3080 | 4          | 80         | 26,27 \$   |
|              | 100A                 | MTSIS-3100 | 4          | 80         | 26,27 \$   |
|              | 125A                 | MTSIS-3125 | 4          | 80         | 26,27 \$   |
| 4P           | 32A                  | MTSIS-4032 | 3          | 60         | 26,27 \$   |
|              | 40A                  | MTSIS-4040 | 3          | 60         | 26,27 \$   |
|              | 63A                  | MTSIS-4063 | 3          | 60         | 28,71 \$   |
|              | 80A                  | MTSIS-4080 | 3          | 60         | 28,71 \$   |
|              | 100A                 | MTSIS-4100 | 3          | 60         | 35,88 \$   |
|              | 125A                 | MTSIS-4125 | 3          | 60         | 37,97 \$   |

**ŞALT GRUBU**
**CE**

### MIR00 SERİSİ



### DARBE AKIM RÖLELERİ

| Kontak  | In (A)<br>Anma Akımı | Ürün Kodu    | Kutu Adedi | Koli Adedi | Fiyat (\$) |
|---------|----------------------|--------------|------------|------------|------------|
| 1NO     | 16A                  | MIR00-123016 | 12         | 120        | 30,11 \$   |
| 2NO     | 16A                  | MIR00-223016 | 12         | 120        | 24,86 \$   |
| 1NO+1NC | 16A                  | MIR00-223031 | 12         | 120        | 30,77 \$   |

### MATRO SERİSİ



### ANALOG ZAMAN SAATİ

| Ürün Kodu | Ürün Adı                    | Kutu Adedi | Koli Adedi | Fiyat (\$) |
|-----------|-----------------------------|------------|------------|------------|
| MATRO-100 | 100 Saat Analog Zaman Saati | 1          | 100        | 29,54 \$   |

**CE**
**CE**

### MTC00 SERİSİ



### TORİD AKIM TRAFOLARI

| Ölçüsü | Ürün Kodu | Kutu Adedi | Koli Adedi | Fiyat (\$) |
|--------|-----------|------------|------------|------------|
| 40 mm  | MTC00-040 | 1          | 100        | 45,80 \$   |
| 80 mm  | MTC00-080 | 1          | 60         | 54,09 \$   |
| 120 mm | MTC00-120 | 1          | 60         | 76,94 \$   |
| 160 mm | MTC00-160 | 1          | 30         | 140,91 \$  |
| 210 mm | MTC00-210 | 1          | 28         | 209,10 \$  |



### KAÇAK AKIM ALGILAMA RÖLESİ

| Ürün Kodu | Ürün Adı                   | Kutu Adedi | Koli Adedi | Fiyat (\$) |
|-----------|----------------------------|------------|------------|------------|
| MELR00-01 | Kaçak Akım Algılama Rölesi | 1          | 36         | 142,05 \$  |

**CE**



## MTL SERİSİ

### KOMPAKT TİP DEVRE KESİCİLER (TERMİK MANYETİK ŞALTER) YANGIN KORUMALI - AÇTIRMA BOBINLİ



| Kutup Sayısı | In (A)<br>Anma Akımı | kA          | Termik Ayar Sahası (Ir) | Ürün Kodu   | mA                      | Kutu Adedi  | Koli Adedi  | Fiyat (\$)  |
|--------------|----------------------|-------------|-------------------------|-------------|-------------------------|-------------|-------------|-------------|
| 4P           | 16A                  | 25 kA       | 13-16A                  | MTL25-4016  | 30 mA - 300 mA - 500 mA | 1           | 18          | 296,15 \$   |
|              | 25A                  |             | 20-25A                  | MTL25-4025  |                         | 1           | 18          | 296,15 \$   |
|              | 32A                  |             | 25-32A                  | MTL25-4032  |                         | 1           | 18          | 296,15 \$   |
|              | 40A                  |             | 32-40A                  | MTL25-4040  |                         | 1           | 18          | 300,00 \$   |
|              | 50A                  |             | 40-50A                  | MTL25-4050  |                         | 1           | 18          | 303,85 \$   |
|              | 63A                  |             | 50-63A                  | MTL25-4063  |                         | 1           | 18          | 307,69 \$   |
|              | 80A                  |             | 63-80A                  | MTL25-4080  |                         | 1           | 18          | 315,38 \$   |
|              | 100A                 |             | 80-100A                 | MTL25-4100  |                         | 1           | 18          | 315,38 \$   |
|              | 125A                 |             | 100-125A                | MTL25-4125  |                         | 1           | 18          | 323,08 \$   |
|              | 100A                 | 35 kA       | 80-100A                 | MTL35-4100  |                         | 1           | 12          | 409,02 \$   |
|              | 125A                 |             | 100-125A                | MTL35-4125  |                         | 1           | 12          | 409,02 \$   |
|              | 160A                 |             | 125-160A                | MTL35-4160  |                         | 1           | 12          | 409,02 \$   |
|              | 200A                 |             | 160-200A                | MTL35-4200  |                         | 1           | 12          | 410,00 \$   |
|              | 250A                 |             | 200-250A                | MTL35-4250  |                         | 1           | 12          | 440,00 \$   |
|              | 315A                 |             | 50 kA                   | -           |                         | MTL50-40315 | 1           | 3           |
|              | 400A                 | -           |                         | MTL50-40400 |                         | 1           | 3           | 793,44 \$   |
|              | 500A                 | -           |                         | MTL50-40500 |                         | 1           | 2           | 1.661,93 \$ |
|              | 630A                 | -           |                         | MTL50-40630 |                         | 1           | 2           | 1.661,93 \$ |
| 800A         | -                    | MTL50-40800 |                         | *           | 1                       | 2           | 1.843,58 \$ |             |

\* 800A Kompakt Tip Devre Kesicilerin Yangın Koruma Kademesi 300 - 500 - 1000 mA' dir.

### KOMPAKT TİP DEVRE KESİCİLER (TERMİK MANYETİK ŞALTER) YANGIN KORUMALI (NÖTRSÜZ - MOTOR DEVRELERİ İÇİN)



| Kutup Sayısı | In (A)<br>Anma Akımı | kA          | Termik Ayar Sahası (Ir) | Ürün Kodu   | mA                      | Kutu Adedi  | Koli Adedi  | Fiyat (\$)  |
|--------------|----------------------|-------------|-------------------------|-------------|-------------------------|-------------|-------------|-------------|
| 3P           | 16A                  | 25 kA       | 13-16A                  | MTL25-3016  | 30 mA - 300 mA - 500 mA | 1           | 24          | 246,13 \$   |
|              | 25A                  |             | 20-25A                  | MTL25-3025  |                         | 1           | 24          | 246,13 \$   |
|              | 32A                  |             | 25-32A                  | MTL25-3032  |                         | 1           | 24          | 256,22 \$   |
|              | 40A                  |             | 32-40A                  | MTL25-3040  |                         | 1           | 24          | 256,22 \$   |
|              | 50A                  |             | 40-50A                  | MTL25-3050  |                         | 1           | 24          | 256,22 \$   |
|              | 63A                  |             | 50-63A                  | MTL25-3063  |                         | 1           | 24          | 264,23 \$   |
|              | 80A                  |             | 63-80A                  | MTL25-3080  |                         | 1           | 24          | 264,23 \$   |
|              | 100A                 |             | 80-100A                 | MTL25-3100  |                         | 1           | 24          | 264,23 \$   |
|              | 125A                 |             | 100-125A                | MTL25-3125  |                         | 1           | 24          | 264,23 \$   |
|              | 100A                 | 35 kA       | 80-100A                 | MTL35-3100  |                         | 1           | 18          | 368,72 \$   |
|              | 125A                 |             | 100-125A                | MTL35-3125  |                         | 1           | 18          | 368,72 \$   |
|              | 160A                 |             | 125-160A                | MTL35-3160  |                         | 1           | 18          | 368,72 \$   |
|              | 200A                 |             | 160-200A                | MTL35-3200  |                         | 1           | 18          | 368,72 \$   |
|              | 250A                 |             | 200-250A                | MTL35-3250  |                         | 1           | 18          | 368,72 \$   |
|              | 315A                 |             | 50 kA                   | -           |                         | MTL50-30315 | 1           | 4           |
|              | 400A                 | -           |                         | MTL50-30400 |                         | 1           | 4           | 645,14 \$   |
|              | 500A                 | -           |                         | MTL50-30500 |                         | 1           | 2           | 1.291,89 \$ |
|              | 630A                 | -           |                         | MTL50-30630 |                         | 1           | 2           | 1.291,89 \$ |
| 800A         | -                    | MTL50-30800 |                         | *           | 1                       | 2           | 1.433,53 \$ |             |

\* 800A Kompakt Tip Devre Kesicilerin Yangın Koruma Kademesi 300 - 500 - 1000 mA' dir.

Seri Kodu

Kiloamper (kA)

Kutup Sayısı

Amper (A)

MTF : Sabit Tip  
MTA : Ayar Sahalı  
MTL : Kaçak Akımlı

25/35/50

3/4

XXXX  
16A...  
1600A

## KOMPAKT TİP DEVRE KESİCİLER (TERMİK MANYETİK ŞALTER) SABİT TİP

CE

MTF SERİSİ

ŞALT GRUBU

| Kutup Sayısı | In (A)<br>Anma Akımı | kA          | Ürün Kodu   | Kutu Adedi | Koli Adedi  | Fiyat (\$)  |
|--------------|----------------------|-------------|-------------|------------|-------------|-------------|
| 3P           | 16A                  | 25<br>kA    | MTF25-3016  | 1          | 24          | 155,42 \$   |
|              | 25A                  |             | MTF25-3025  | 1          | 24          | 155,42 \$   |
|              | 32A                  |             | MTF25-3032  | 1          | 24          | 155,42 \$   |
|              | 40A                  |             | MTF25-3040  | 1          | 24          | 155,42 \$   |
|              | 50A                  |             | MTF25-3050  | 1          | 24          | 155,42 \$   |
|              | 63A                  |             | MTF25-3063  | 1          | 24          | 168,01 \$   |
|              | 80A                  |             | MTF25-3080  | 1          | 24          | 168,01 \$   |
|              | 100A                 |             | MTF25-3100  | 1          | 24          | 168,01 \$   |
|              | 125A                 |             | MTF25-3125  | 1          | 24          | 168,01 \$   |
|              | 160A                 |             | MTF25-3160  | 1          | 24          | 175,34 \$   |
|              | 100A                 | 35<br>kA    | MTF35-3100  | 1          | 18          | 226,75 \$   |
|              | 125A                 |             | MTF35-3125  | 1          | 18          | 226,75 \$   |
|              | 160A                 |             | MTF35-3160  | 1          | 18          | 226,75 \$   |
|              | 200A                 |             | MTF35-3200  | 1          | 18          | 226,75 \$   |
|              | 250A                 |             | MTF35-3250  | 1          | 18          | 226,75 \$   |
|              | 315A                 | 50<br>kA    | MTF50-30315 | 1          | 4           | 674,41 \$   |
|              | 400A                 |             | MTF50-30400 | 1          | 4           | 674,41 \$   |
|              | 500A                 |             | MTF50-30500 | 1          | 2           | 1.014,19 \$ |
|              | 630A                 |             | MTF50-30630 | 1          | 2           | 1.014,19 \$ |
|              | 800A                 | 65<br>kA    | MTF50-30800 | 1          | 2           | 1.347,79 \$ |
|              | 1000A                |             | MTF65-31000 | 1          | 1           | 2.115,39 \$ |
| 1250A        | MTF65-31250          |             | 1           | 1          | 2.178,51 \$ |             |
| 1600A        |                      | MTF65-31600 | 1           | 1          | 2.583,06 \$ |             |
| 4P           | 16A                  | 25<br>kA    | MTF25-4016  | 1          | 18          | 191,09 \$   |
|              | 25A                  |             | MTF25-4025  | 1          | 18          | 191,09 \$   |
|              | 32A                  |             | MTF25-4032  | 1          | 18          | 191,09 \$   |
|              | 40A                  |             | MTF25-4040  | 1          | 18          | 191,09 \$   |
|              | 50A                  |             | MTF25-4050  | 1          | 18          | 191,09 \$   |
|              | 63A                  |             | MTF25-4063  | 1          | 18          | 205,75 \$   |
|              | 80A                  |             | MTF25-4080  | 1          | 18          | 205,75 \$   |
|              | 100A                 |             | MTF25-4100  | 1          | 18          | 205,75 \$   |
|              | 125A                 |             | MTF25-4125  | 1          | 18          | 205,75 \$   |
|              | 160A                 |             | MTF25-4160  | 1          | 18          | 213,08 \$   |
|              | 100A                 | 35<br>kA    | MTF35-4100  | 1          | 12          | 302,24 \$   |
|              | 125A                 |             | MTF35-4125  | 1          | 12          | 302,24 \$   |
|              | 160A                 |             | MTF35-4160  | 1          | 12          | 302,24 \$   |
|              | 200A                 |             | MTF35-4200  | 1          | 12          | 302,24 \$   |
|              | 250A                 |             | MTF35-4250  | 1          | 12          | 302,24 \$   |
|              | 315A                 | 50<br>kA    | MTF50-40315 | 1          | 3           | 778,32 \$   |
|              | 400A                 |             | MTF50-40400 | 1          | 3           | 778,32 \$   |
|              | 500A                 |             | MTF50-40500 | 1          | 2           | 1.249,95 \$ |
|              | 630A                 |             | MTF50-40630 | 1          | 2           | 1.249,95 \$ |
|              | 800A                 | 65<br>kA    | MTF50-40800 | 1          | 2           | 1.420,99 \$ |
|              | 1000A                |             | MTF65-41000 | 1          | 1           | 2.961,54 \$ |
| 1250A        | MTF65-41250          |             | 1           | 1          | 2.975,36 \$ |             |
| 1600A        |                      | MTF65-41600 | 1           | 1          | 3.326,43 \$ |             |





## KOMPAKT TİP DEVRE KESİCİLER (TERMİK MANYETİK) AYAR SAHALI

### MTA SERİSİ



| Kutup Sayısı | In (A)<br>Anma Akımı | kA       | Termik Ayar<br>Sahası (Ir) | Ürün Kodu   | Kutu<br>Adedi | Koli<br>Adedi | Fiyat<br>(\$) |
|--------------|----------------------|----------|----------------------------|-------------|---------------|---------------|---------------|
| 3P           | 16A                  | 25<br>kA | 13-16A                     | MTA25-3016  | 1             | 24            | 187,01 \$     |
|              | 25A                  |          | 20-25A                     | MTA25-3025  | 1             | 24            | 187,01 \$     |
|              | 32A                  |          | 25-32A                     | MTA25-3032  | 1             | 24            | 187,01 \$     |
|              | 40A                  |          | 32-40A                     | MTA25-3040  | 1             | 24            | 192,35 \$     |
|              | 50A                  |          | 40-50A                     | MTA25-3050  | 1             | 24            | 192,35 \$     |
|              | 63A                  |          | 50-63A                     | MTA25-3063  | 1             | 24            | 205,84 \$     |
|              | 80A                  |          | 63-80A                     | MTA25-3080  | 1             | 24            | 205,84 \$     |
|              | 100A                 |          | 80-100A                    | MTA25-3100  | 1             | 24            | 212,95 \$     |
|              | 125A                 |          | 100-125A                   | MTA25-3125  | 1             | 24            | 219,29 \$     |
|              | 160A                 |          | 125-160A                   | MTA25-3160  | 1             | 24            | 230,77 \$     |
|              | 100A                 | 35<br>kA | 80-100A                    | MTA35-3100  | 1             | 18            | 250,00 \$     |
|              | 125A                 |          | 100-125A                   | MTA35-3125  | 1             | 18            | 263,94 \$     |
|              | 160A                 |          | 125-160A                   | MTA35-3160  | 1             | 18            | 274,50 \$     |
|              | 200A                 |          | 160-200A                   | MTA35-3200  | 1             | 18            | 307,69 \$     |
|              | 250A                 |          | 200-250A                   | MTA35-3250  | 1             | 18            | 330,77 \$     |
|              | 315A                 | 50<br>kA | 250-315A                   | MTA50-30315 | 1             | 4             | 720,69 \$     |
|              | 400A                 |          | 320-400A                   | MTA50-30400 | 1             | 4             | 785,67 \$     |
|              | 500A                 |          | 400-500A                   | MTA50-30500 | 1             | 2             | 1.056,23 \$   |
|              | 630A                 |          | 500-630A                   | MTA50-30630 | 1             | 2             | 1.056,23 \$   |
|              | 800A                 | 630-800A | MTA50-30800                | 1           | 2             | 1.300,70 \$   |               |



|    |      |          |             |             |   |             |             |
|----|------|----------|-------------|-------------|---|-------------|-------------|
| 4P | 16A  | 25<br>kA | 13-16A      | MTA25-4016  | 1 | 18          | 235,28 \$   |
|    | 25A  |          | 20-25A      | MTA25-4025  | 1 | 18          | 235,28 \$   |
|    | 32A  |          | 25-32A      | MTA25-4032  | 1 | 18          | 235,28 \$   |
|    | 40A  |          | 32-40A      | MTA25-4040  | 1 | 18          | 241,57 \$   |
|    | 50A  |          | 40-50A      | MTA25-4050  | 1 | 18          | 251,93 \$   |
|    | 63A  |          | 50-63A      | MTA25-4063  | 1 | 18          | 251,93 \$   |
|    | 80A  |          | 63-80A      | MTA25-4080  | 1 | 18          | 258,53 \$   |
|    | 100A |          | 80-100A     | MTA25-4100  | 1 | 18          | 258,53 \$   |
|    | 125A |          | 100-125A    | MTA25-4125  | 1 | 18          | 263,48 \$   |
|    | 160A |          | 125-160A    | MTA25-4160  | 1 | 18          | 271,67 \$   |
|    | 100A | 35<br>kA | 80-100A     | MTA35-4100  | 1 | 12          | 280,88 \$   |
|    | 125A |          | 100-125A    | MTA35-4125  | 1 | 12          | 280,88 \$   |
|    | 160A |          | 125-160A    | MTA35-4160  | 1 | 12          | 300,37 \$   |
|    | 200A |          | 160-200A    | MTA35-4200  | 1 | 12          | 352,34 \$   |
|    | 250A |          | 200-250A    | MTA35-4250  | 1 | 12          | 378,30 \$   |
|    | 315A | 50<br>kA | 250-315A    | MTA50-40315 | 1 | 3           | 748,39 \$   |
|    | 400A |          | 320-400A    | MTA50-40400 | 1 | 3           | 748,39 \$   |
|    | 500A |          | 400-500A    | MTA50-40500 | 1 | 2           | 1.201,87 \$ |
|    | 630A |          | 500-630A    | MTA50-40630 | 1 | 2           | 1.201,87 \$ |
|    | 800A | 630-800A | MTA50-40800 | 1           | 2 | 1.923,08 \$ |             |

## KOMPAKT TİP DEVRE KESİCİLERİ (TERMİK MANYETİK) AKSESUARLARI

| Ürün Kodu     | Ürün Adı  | Kutu Adedi | Fiyat (\$)    |
|---------------|---|------------|---------------|
| MTAUX-11250   | 1NO + 1NC - Yardımcı Kontak - 25kA - 35kA Kasa için           | 1          | FİYAT SORUNUZ |
| MTAUX-22250   | 2NO + 2NC - Yardımcı Kontak - 25kA - 35kA Kasa için           | 1          |               |
| MTAUX-22400   | 2NO + 2NC - Yardımcı Kontak - MTF - MTA 50kA Kasa için        | 1          |               |
| MTAUX-22800   | 2NO + 2NC - Yardımcı Kontak - MTL - 50kA Kasa için            | 1          |               |
| MTAUX-221250  | 2NO + 2NC - Yardımcı Kontak - MTF - 65kA Kasa için            | 1          |               |
| MTALR-00160   | Alarm Kontak - 25kA Kasa için                                 | 1          |               |
| MTALR-00250   | Alarm Kontak - 35kA Kasa için                                 | 1          |               |
| MTALR-00400   | Alarm Kontak - MTF - MTA - 50kA Kasa için                     | 1          |               |
| MTALR-00800   | Alarm Kontak - MTL - 50kA Kasa için                           | 1          |               |
| MTALR-001250  | Alarm Kontak - MTF - 65kA Kasa için                           | 1          |               |
| MTSHT-230160  | Açtırma Bobini - 25kA Kasa için                               | 1          |               |
| MTSHT-230250  | Açtırma Bobini - 35kA Kasa için                               | 1          |               |
| MTSHT-230400  | Açtırma Bobini - MTL - 50kA (315A - 400A) Kasa için           | 1          |               |
| MTSHT-230500  | Açtırma Bobini - MTL - 50kA (500A - 800A) Kasa için           | 1          |               |
| MTSHT-230630  | Açtırma Bobini - MTF - MTA - 50kA (315A - 630A) Kasa için     | 1          |               |
| MTSHT-230800  | Açtırma Bobini - MTF - MTA - 50kA (800A) Kasa için            | 1          |               |
| MTSHT-2301250 | Açtırma Bobini - MTF - 65kA Kasa için                         | 1          |               |
| MTMO-0250     | Motor Mekanizması - 35kA Kasa için                            | 1          |               |
| MTMO-0400     | Motor Mekanizması - MTF - MTA - 50kA (315A - 400A) Kasa için  | 1          |               |
| MTMO-0630     | Motor Mekanizması - MTF - MTA - 50kA (500A - 630A) Kasa için  | 1          |               |
| MTMO-0800     | Motor Mekanizması - MTF - MTA - 50kA (800A) Kasa için         | 1          |               |
| MTMO-0315     | Motor Mekanizması - MTL - 50kA (315A - 400A) Kasa için        | 1          |               |
| MTMO-0500     | Motor Mekanizması - MTL - 50kA (500A - 800A) Kasa için        | 1          |               |
| MTMO-1000     | Motor Mekanizması - MTF - 65kA Kasa için                      | 1          |               |
| MTRH-0250     | Döner Uzatma Kolu - 35kA Kasa için                            | 1          |               |
| MTRH-0400     | Döner Uzatma Kolu - MTF - MTA - 50kA (315A - 400A) Kasa için  | 1          |               |
| MTRH-0630     | Döner Uzatma Kolu - MTF - MTA - 50kA (500A - 630A) Kasa için  | 1          |               |
| MTRH-0800     | Döner Uzatma Kolu - MTF - MTA - 50kA (800A) Kasa için         | 1          |               |
| MTRH-0315     | Döner Uzatma Kolu - MTL - 50kA (315A - 400A) Kasa için        | 1          |               |
| MTRH-0500     | Döner Uzatma Kolu - MTL - 50kA (500A - 800A) Kasa için        | 1          |               |
| MTRH-1000     | Döner Uzatma Kolu - MTF - 65kA Kasa için                      | 1          |               |
| MTIUUV-00400  | Düşük Gerilim Bobini - MTF - MTA - 50kA Kasa için             | 1          |               |
| MTIUUV-00800  | Düşük Gerilim Bobini - MTL - 50kA Kasa için                   | 1          |               |
| MTLAM-00800   | Kaçak Akım Alarm Modülü - MTL - 50kA Kasa için                | 1          |               |
| MTSACC-SL3    | Emniyet Kilidi Aparatı - 25kA - 35kA Kasa için                | 1          |               |
| MTSACC-SL4    | Emniyet Kilidi Aparatı - 50kA (315A - 630A) Kasa için         | 1          |               |
| MTSACC-SL5    | Emniyet Kilidi Aparatı - 50kA - 65kA (800A - 1250A) Kasa için | 1          |               |

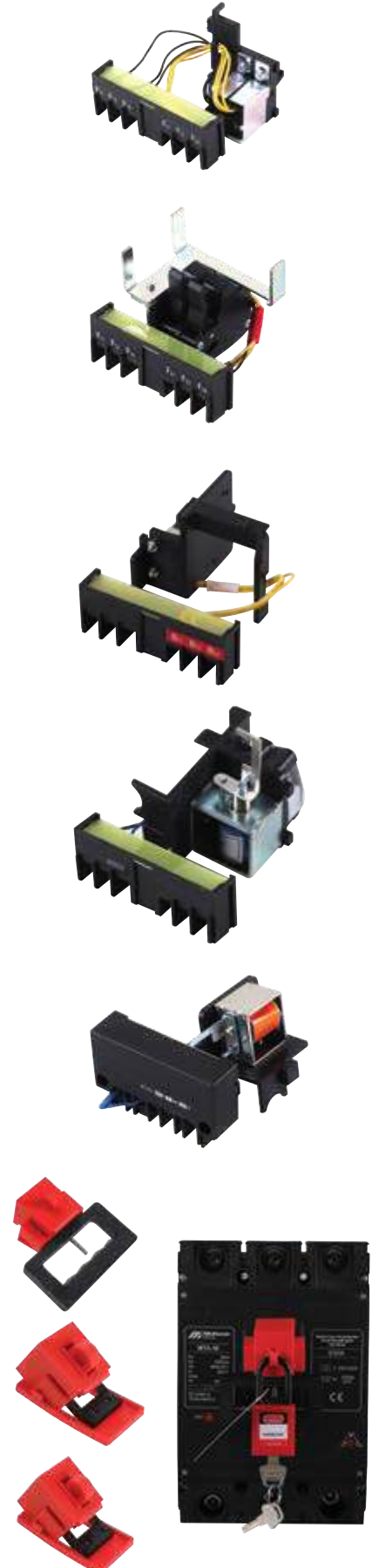

## CE AÇIK TİP DEVRE KESİCİLER - SABİT TİP

### MTACF SERİSİ



| Kutup Sayısı | In (A) Anma Akımı | kA             | Ürün Kodu      | Kutu Adedi | Koli Adedi   | Fiyat (\$)   |
|--------------|-------------------|----------------|----------------|------------|--------------|--------------|
| 3P           | 1000A             | 65 kA          | MTACF3-0651000 | 1          | 1            | 3.471,49 \$  |
|              | 1250A             |                | MTACF3-0651250 | 1          | 1            | 3.471,49 \$  |
|              | 1600A             |                | MTACF3-0651600 | 1          | 1            | 3.471,49 \$  |
|              | 2000A             |                | MTACF3-0652000 | 1          | 1            | 4.947,81 \$  |
|              | 2500A             |                | MTACF3-0652500 | 1          | 1            | 4.947,81 \$  |
|              | 3200A             |                | MTACF3-0653200 | 1          | 1            | 5.513,99 \$  |
|              | 4000A             | 120 kA         | MTACF3-1204000 | 1          | 1            | 12.537,95 \$ |
|              | 5000A             |                | MTACF3-1205000 | 1          | 1            | 14.452,33 \$ |
|              | 6300A             | MTACF3-1206300 | 1              | 1          | 16.245,43 \$ |              |
| 4P           | 1000A             | 65 kA          | MTACF4-0651000 | 1          | 1            | 4.307,40 \$  |
|              | 1250A             |                | MTACF4-0651250 | 1          | 1            | 4.307,40 \$  |
|              | 1600A             |                | MTACF4-0651600 | 1          | 1            | 4.307,40 \$  |
|              | 2000A             |                | MTACF4-0652000 | 1          | 1            | 6.403,79 \$  |
|              | 2500A             |                | MTACF4-0652500 | 1          | 1            | 6.403,79 \$  |
|              | 3200A             |                | MTACF4-0653200 | 1          | 1            | 7.414,88 \$  |
|              | 4000A             | 120 kA         | MTACF4-1204000 | 1          | 1            | 14.775,87 \$ |
|              | 5000A             |                | MTACF4-1205000 | 1          | 1            | 15.908,32 \$ |
|              | 6300A             | MTACF4-1206300 | 1              | 1          | 17.458,77 \$ |              |

## CE AÇIK TİP DEVRE KESİCİLER - ÇEKMECELİ TİP

### MTACD SERİSİ



| Kutup Sayısı | In (A) Anma Akımı | kA             | Ürün Kodu      | Kutu Adedi | Koli Adedi   | Fiyat (\$)   |
|--------------|-------------------|----------------|----------------|------------|--------------|--------------|
| 3P           | 1000A             | 65 kA          | MTACD3-0651000 | 1          | 1            | 5.075,84 \$  |
|              | 1250A             |                | MTACD3-0651250 | 1          | 1            | 5.075,84 \$  |
|              | 1600A             |                | MTACD3-0651600 | 1          | 1            | 5.075,84 \$  |
|              | 2000A             |                | MTACD3-0652000 | 1          | 1            | 5.911,75 \$  |
|              | 2500A             |                | MTACD3-0652500 | 1          | 1            | 7.994,65 \$  |
|              | 3200A             |                | MTACD3-0653200 | 1          | 1            | 9.275,37 \$  |
|              | 4000A             | 120 kA         | MTACD3-1204000 | 1          | 1            | 15.126,39 \$ |
|              | 5000A             |                | MTACD3-1205000 | 1          | 1            | 23.471,56 \$ |
|              | 6300A             | MTACD3-1206300 | 1              | 1          | 27.502,57 \$ |              |
| 4P           | 1000A             | 65 kA          | MTACD4-0651000 | 1          | 1            | 6.194,79 \$  |
|              | 1250A             |                | MTACD4-0651250 | 1          | 1            | 6.194,79 \$  |
|              | 1600A             |                | MTACD4-0651600 | 1          | 1            | 6.194,79 \$  |
|              | 2000A             |                | MTACD4-0652000 | 1          | 1            | 10.353,92 \$ |
|              | 2500A             |                | MTACD4-0652500 | 1          | 1            | 10.353,92 \$ |
|              | 3200A             |                | MTACD4-0653200 | 1          | 1            | 12.133,53 \$ |
|              | 4000A             | 120 kA         | MTACD4-1204000 | 1          | 1            | 18.847,36 \$ |
|              | 5000A             |                | MTACD4-1205000 | 1          | 1            | 26.612,77 \$ |
|              | 6300A             | MTACD4-1206300 | 1              | 1          | 28.581,13 \$ |              |

## AÇIK TİP DEVRE KESİCİLERİ AKSESUARLARI

| Ürün Kodu     | Ürün Adı  | Kutu Adedi | Fiyat (\$) |
|---------------|---|------------|------------|
| MTACSHT-1000  | Açtırma Bobini (1000-1600A)   | 1          |            |
| MTACSHT-2000  | Açtırma Bobini (2000A)  | 1          |            |
| MTACSHT-4000  | Açtırma Bobini (2500-4000A)   | 1          |            |
| MTACSHT-6300  | Açtırma Bobini (5000-6300A)   | 1          |            |
| MTACIUUV-1000 | Düşük Gerilim Bobini (1000-1600A)                                       | 1          |            |
| MTACIUUV-2000 | Düşük Gerilim Bobini (2000A)  | 1          |            |
| MTACIUUV-4000 | Düşük Gerilim Bobini (2500-4000A)                                       | 1          |            |
| MTACIUUV-6300 | Düşük Gerilim Bobini (5000-6300A)                                       | 1          |            |
| MTACSUV-1000  | Gecikmesiz Düşük Gerilim Bobini (1000-1600A)                            | 1          |            |
| MTACSUV-2000  | Gecikmesiz Düşük Gerilim Bobini (2000A)                                 | 1          |            |
| MTACSUV-4000  | Gecikmesiz Düşük Gerilim Bobini (2500-4000A)                            | 1          |            |
| MTACSUV-6300  | Gecikmesiz Düşük Gerilim Bobini (5000-6300A)                            | 1          |            |
| MTACUV-1000   | Gecikmeli Düşük Gerilim Bobini (1000-1600A)                             | 1          |            |
| MTACUV-2000   | Gecikmeli Düşük Gerilim Bobini (2000A)                                  | 1          |            |
| MTACUV-4000   | Gecikmeli Düşük Gerilim Bobini (2500-4000A)                             | 1          |            |
| MTACUV-6300   | Gecikmeli Düşük Gerilim Bobini (5000-6300A)                             | 1          |            |
| MTACM-1000    | Motor Mekanizması (1000-1600A)  | 1          |            |
| MTACM-2000    | Motor Mekanizması (2000A)   | 1          |            |
| MTACM-4000    | Motor Mekanizması (2500-4000A)  | 1          |            |
| MTACM-6300    | Motor Mekanizması (5000-6300A)  | 1          |            |
| MTACCC-1000   | Kapatma Bobini (1000-1600A)   | 1          |            |
| MTACCC-2000   | Kapatma Bobini (2000A)  | 1          |            |
| MTACCC-4000   | Kapatma Bobini (2500-4000A)   | 1          |            |
| MTACCC-6300   | Kapatma Bobini (5000-6300A)   | 1          |            |
| MTACMIM2-1000 | Mekanik Kilitleme Ünitesi 2 Devre Kesici için (1000-1600A)              | 1          |            |
| MTACMIM2-2000 | Mekanik Kilitleme Ünitesi 2 Devre Kesici için (2000A)                   | 1          |            |
| MTACMIM2-4000 | Mekanik Kilitleme Ünitesi 2 Devre Kesici için (2500-4000A)              | 1          |            |
| MTACMIM2-6300 | Mekanik Kilitleme Ünitesi 2 Devre Kesici için (5000-6300A)              | 1          |            |
| MTACMIM3-1000 | Mekanik Kilitleme Ünitesi 3 Devre Kesici için (2 ON+1 OFF) (1000-1600A) | 1          |            |
| MTACMIM3-2000 | Mekanik Kilitleme Ünitesi 3 Devre Kesici için (2 ON+1 OFF)(2000A)       | 1          |            |
| MTACMIM3-4000 | Mekanik Kilitleme Ünitesi 3 Devre Kesici için (2 ON+1 OFF)(2500-4000A)  | 1          |            |
| MTACMIM3-6300 | Mekanik Kilitleme Ünitesi 3 Devre Kesici için (2 ON+1 OFF) (5000-6300A) | 1          |            |
| MTAC1MC-1000  | LSI Dijital Ekranlı Kontrol Ünitesi (1000-1600A)                        | 1          |            |
| MTAC1MC-2000  | LSI Dijital Ekranlı Kontrol Ünitesi (2000A)                             | 1          |            |
| MTAC1MC-4000  | LSI Dijital Ekranlı Kontrol Ünitesi (2500-4000A)                        | 1          |            |
| MTAC1MC-6300  | LSI Dijital Ekranlı Kontrol Ünitesi (5000-6300A)                        | 1          |            |
| MTAC3MC-1000  | LSIG LCD Ekranlı Kontrol Ünitesi (1000-1600A)                           | 1          |            |
| MTAC3MC-2000  | LSIG LCD Ekranlı Kontrol Ünitesi (2000A)                                | 1          |            |
| MTAC3MC-4000  | LSIG LCD Ekranlı Kontrol Ünitesi (2500-4000A)                           | 1          |            |
| MTAC3MC-6300  | LSIG LCD Ekranlı Kontrol Ünitesi (5000-6300A)                           | 1          |            |
| MTAC3HC-1000  | LSIG Çok Fonksiyonlu LCD Ekranlı Kontrol Ünitesi (1000-1600A)           | 1          |            |
| MTAC3HC-2000  | LSIG Çok Fonksiyonlu LCD Ekranlı Kontrol Ünitesi (2000A)                | 1          |            |
| MTAC3HC-4000  | LSIG Çok Fonksiyonlu LCD Ekranlı Kontrol Ünitesi (2500-4000A)           | 1          |            |
| MTAC3HC-6300  | LSIG Çok Fonksiyonlu LCD Ekranlı Kontrol Ünitesi (5000-6300A)           | 1          |            |
| MTACN-1000    | Nötr Akım Trafosu (1000-1600A)  | 1          |            |
| MTACN-2000    | Nötr Akım Trafosu (2000A)   | 1          |            |
| MTACN-4000    | Nötr Akım Trafosu (2500-4000A)  | 1          |            |
| MTACN-6300    | Nötr Akım Trafosu (5000-6300A)  | 1          |            |
| MTACZP-1000   | Toprak Akım Trafosu (1000-1600A)  | 1          |            |
| MTACZP-2000   | Toprak Akım Trafosu (2000A)   | 1          |            |
| MTACZP-4000   | Toprak Akım Trafosu (2500-4000A)  | 1          |            |
| MTACZP-6300   | Toprak Akım Trafosu (5000-6300A)  | 1          |            |
| MTACPS-1000   | Faz Seperatörü (1000-1600A)   | 1          |            |
| MTACPS-2000   | Faz Seperatörü (2000A)  | 1          |            |
| MTACPS-4000   | Faz Seperatörü (2500-4000A)   | 1          |            |
| MTACPS-6300   | Faz Seperatörü (5000-6300A)   | 1          |            |
| MTACDF-1000   | Kapı Çerçevesi (1000-1600A)   | 1          |            |
| MTACDF-2000   | Kapı Çerçevesi (2000A)  | 1          |            |
| MTACDF-4000   | Kapı Çerçevesi (2500-4000A)   | 1          |            |
| MTACDF-6300   | Kapı Çerçevesi (5000-6300A)   | 1          |            |

**FİYAT SORUNUZ**



Kapatma Bobinleri

Açtırma Bobinleri



Düşük Gerilim Bobini



Motor Mekanizması



İkili Mekanik Kilitleme

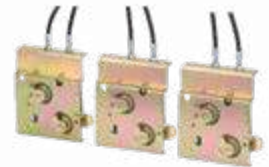

Üçlü Mekanik Kilitleme



Ekranlı Kontrol Ünitesi



Nötr Akım Trafosu



Toprak Akım Trafosu

## CE OTOMATİK TRANSFER ŞALTERLERİ (ATS) KÜÇÜK KASA

### MATS SERİSİ



| Kutup Sayısı | In (A)<br>Anma Akımı | Ürün Kodu | Kutu Adedi | Fiyat (\$)    |
|--------------|----------------------|-----------|------------|---------------|
| 2P           | 10A                  | MATS-2010 | 1          | FİYAT SORUNUZ |
|              | 16A                  | MATS-2016 | 1          |               |
|              | 20A                  | MATS-2020 | 1          |               |
|              | 25A                  | MATS-2025 | 1          |               |
|              | 32A                  | MATS-2032 | 1          |               |
|              | 40A                  | MATS-2040 | 1          |               |
|              | 50A                  | MATS-2050 | 1          |               |
| 63A          | MATS-2063            | 1         |            |               |
| 4P           | 10A                  | MATS-4010 | 1          |               |
|              | 16A                  | MATS-4016 | 1          |               |
|              | 20A                  | MATS-4020 | 1          |               |
|              | 25A                  | MATS-4025 | 1          |               |
|              | 32A                  | MATS-4032 | 1          |               |
|              | 40A                  | MATS-4040 | 1          |               |
|              | 50A                  | MATS-4050 | 1          |               |
| 63A          | MATS-4063            | 1         |            |               |

**MTATS**  
Oto. Transfer Şalteri  
Seri Kodu - Kutup Sayısı 4 - Amper (A) XXX 100A...3200A

## CE OTOMATİK TRANSFER ŞALTERLERİ (ATS)

### MTATS SERİSİ



| Kutup Sayısı | In (A)<br>Anma Akımı | Ürün Kodu   | Kutu Adedi   | Fiyat (\$)   |
|--------------|----------------------|-------------|--------------|--------------|
| 4P           | 100A                 | MTATS-40100 | 1            | 450,00 \$    |
|              | 160A                 | MTATS-40160 | 1            | 692,31 \$    |
|              | 250A                 | MTATS-40250 | 1            | 769,23 \$    |
|              | 400A                 | MTATS-40400 | 1            | 1.200,00 \$  |
|              | 630A                 | MTATS-40630 | 1            | 1.615,38 \$  |
|              | 1000A                | MTATS-41000 | 1            | 3.269,23 \$  |
|              | 1250A                | MTATS-41250 | 1            | 3.769,23 \$  |
|              | 1600A                | MTATS-41600 | 1            | 4.230,77 \$  |
|              | 2000A                | MTATS-42000 | 1            | 9.230,77 \$  |
|              | 2500A                | MTATS-42500 | 1            | 11.000,00 \$ |
| 3200A        | MTATS-43200          | 1           | 13.000,00 \$ |              |

|                           |                                      |                     |                  |
|---------------------------|--------------------------------------|---------------------|------------------|
| <b>MTMA</b>               | <b>Kontakt</b>                       | <b>Kutup Sayısı</b> | <b>Amper (A)</b> |
| AC Kontaktör<br>Seri Kodu | 10 : 1NO<br>01 : 1NC<br>11 : 1NO+1NC | 3/4                 | XXX<br>9A...95A  |

## AC KONTAKTÖRLER - 230V AC

| Kutup Sayısı | In (A)<br>Anma Akımı | kW      | Kontakt     | Voltaj (V)  | Ürün Kodu   | Kutu Adedi | Koli Adedi | Fiyat (\$) |
|--------------|----------------------|---------|-------------|-------------|-------------|------------|------------|------------|
| 3P           | 9A                   | 4kW     | 1NO         | 230V<br>AC  | MTMA10-3009 | 1          | 50         | 17,60 \$   |
|              | 9A                   | 4kW     | 1NC         |             | MTMA01-3009 | 1          | 50         | 17,60 \$   |
|              | 9A                   | 4kW     | 1NO+1NC     |             | MTMA11-3009 | 1          | 50         | 19,23 \$   |
|              | 12A                  | 5,5kW   | 1NO         |             | MTMA10-3012 | 1          | 50         | 19,23 \$   |
|              | 12A                  | 5,5kW   | 1NC         |             | MTMA01-3012 | 1          | 50         | 19,23 \$   |
|              | 12A                  | 5,5kW   | 1NO+1NC     |             | MTMA11-3012 | 1          | 50         | 23,08 \$   |
|              | 18A                  | 7,5kW   | 1NO         |             | MTMA10-3018 | 1          | 50         | 23,08 \$   |
|              | 18A                  | 7,5kW   | 1NC         |             | MTMA01-3018 | 1          | 50         | 23,08 \$   |
|              | 18A                  | 7,5kW   | 1NO+1NC     |             | MTMA11-3018 | 1          | 50         | 25,00 \$   |
|              | 25A                  | 11kW    | 1NO         |             | MTMA10-3025 | 1          | 50         | 30,92 \$   |
|              | 25A                  | 11kW    | 1NC         |             | MTMA01-3025 | 1          | 50         | 30,92 \$   |
|              | 25A                  | 11kW    | 1NO+1NC     |             | MTMA11-3025 | 1          | 50         | 32,69 \$   |
|              | 32A                  | 15kW    | 1NO         |             | MTMA10-3032 | 1          | 50         | 38,46 \$   |
|              | 32A                  | 15kW    | 1NC         |             | MTMA01-3032 | 1          | 50         | 38,46 \$   |
|              | 32A                  | 15kW    | 1NO+1NC     |             | MTMA11-3032 | 1          | 50         | 42,31 \$   |
|              | 40A                  | 18,5kW  | 1NO+1NC     |             | MTMA11-3040 | 1          | 20         | 73,08 \$   |
|              | 50A                  | 22kW    | 1NO+1NC     |             | MTMA11-3050 | 1          | 20         | 75,14 \$   |
|              | 65A                  | 30kW    | 1NO+1NC     |             | MTMA11-3065 | 1          | 20         | 88,52 \$   |
| 80A          | 37kW                 | 1NO+1NC | MTMA11-3080 | 1           | 12          | 113,46 \$  |            |            |
| 95A          | 45kW                 | 1NO+1NC | MTMA11-3095 | 1           | 12          | 117,31 \$  |            |            |
| 4P           | 9A                   | 4kW     | -           | MTMA00-4009 | 1           | 50         | 26,50 \$   |            |
|              | 12A                  | 5,5kW   | -           | MTMA00-4012 | 1           | 50         | 26,50 \$   |            |
|              | 18A                  | 7,5kW   | -           | MTMA00-4018 | 1           | 50         | 26,50 \$   |            |
|              | 25A                  | 11kW    | -           | MTMA00-4025 | 1           | 50         | 40,15 \$   |            |
|              | 32A                  | 15kW    | -           | MTMA00-4032 | 1           | 50         | 40,15 \$   |            |
|              | 40A                  | 18,5kW  | -           | MTMA00-4040 | 1           | 20         | 105,79 \$  |            |
|              | 50A                  | 22kW    | -           | MTMA00-4050 | 1           | 20         | 120,38 \$  |            |
|              | 65A                  | 30kW    | -           | MTMA00-4065 | 1           | 20         | 141,21 \$  |            |
|              | 80A                  | 37kW    | -           | MTMA00-4080 | 1           | 20         | 188,67 \$  |            |
|              | 95A                  | 45kW    | -           | MTMA00-4095 | 1           | 20         | 197,93 \$  |            |



## MTMA SERİSİ



## AC/DC KONTAKTÖRLER GÜÇ DEVRESİ AC, KUMANDA DEVRESİ AC/ DC

| Kutup Sayısı | In (A)<br>Anma Akımı | kW      | Kontakt      | Voltaj (V)                  | Ürün Kodu    | Kutu Adedi | Koli Adedi | Fiyat (\$)               |
|--------------|----------------------|---------|--------------|-----------------------------|--------------|------------|------------|--------------------------|
| 3P           | 9A                   | 4kW     | 1NO+1NC      | 24-48V<br>100-240V<br>AC/DC | MTMAD11-3009 | 1          | 50         | <b>FIYAT<br/>SORUNUZ</b> |
|              | 12A                  | 5,5kW   | 1NO+1NC      |                             | MTMAD11-3012 | 1          | 50         |                          |
|              | 18A                  | 7,5kW   | 1NO+1NC      |                             | MTMAD11-3018 | 1          | 50         |                          |
|              | 25A                  | 11kW    | 1NO+1NC      |                             | MTMAD11-3025 | 1          | 50         |                          |
|              | 32A                  | 15kW    | 1NO+1NC      |                             | MTMAD11-3032 | 1          | 50         |                          |
|              | 40A                  | 18,5kW  | 1NO+1NC      |                             | MTMAD11-3040 | 1          | 20         |                          |
|              | 50A                  | 22kW    | 1NO+1NC      |                             | MTMAD11-3050 | 1          | 20         |                          |
|              | 65A                  | 30kW    | 1NO+1NC      |                             | MTMAD11-3065 | 1          | 20         |                          |
|              | 80A                  | 37kW    | 1NO+1NC      |                             | MTMAD11-3080 | 1          | 12         |                          |
|              | 95A                  | 45kW    | 1NO+1NC      |                             | MTMAD11-3095 | 1          | 12         |                          |
|              | 120A                 | 55kW    | 2NO+2NC      | 110-230-400V<br>AC/DC       | MTMAD22-3120 | 1          | 1          |                          |
|              | 160A                 | 75kW    | 2NO+2NC      |                             | MTMAD22-3160 | 1          | 1          |                          |
|              | 185A                 | 90kW    | 2NO+2NC      |                             | MTMAD22-3185 | 1          | 1          |                          |
|              | 225A                 | 110kW   | 2NO+2NC      |                             | MTMAD22-3225 | 1          | 1          |                          |
| 265A         | 132kW                | 2NO+2NC | MTMAD22-3265 |                             | 1            | 1          |            |                          |



## MTMAD SERİSİ



9A - 95A



120A - 265A



Yardımcı Kontaktörler



Zaman Rölesi

Mekanik Kilitleme

## KONTAKTÖR YARDIMCI AKSESUARLARI

| Ürün Kodu        | Ürün Adı  | Kutu Adedi | Koli Adedi | Fiyat (\$) |
|------------------|---|------------|------------|------------|
| MTMAUX-UPBLOCKA  | Kontaktör Üst Blok A (1NO + 1NC)                  | 1          | 300        | 5,24 \$    |
| MTMAUX-UPBLOCKB  | Kontaktör Üst Blok B (2NO + 2NC)                  | 1          | 208        | 8,61 \$    |
| MTMAUX-SIDEBLOCK | Kontaktör Yan Blok (9A-32A) Kasa için (1NO + 1NC) | 1          | 128        | 11,31 \$   |
| MTMAUX-T030      | 0-30 Saniye Zaman Rölesi                          | 1          | 50         | 15,88 \$   |
| MTMAUX-MI32      | 9-32A Mekanik Kilitleme                           | 1          | 50         | 11,80 \$   |
| MTMAUX-MI95      | 40-95A Mekanik Kilitleme                          | 1          | 50         | 14,00 \$   |

| MTMK                     | Kontakt              | Kutup Sayısı | Amper (A)       | Akım Tipi                |
|--------------------------|----------------------|--------------|-----------------|--------------------------|
| Mini Kontaktör Seri Kodu | 10 : 1NO<br>01 : 1NC | 3            | XXX<br>9A...16A | 230V AC<br>24V DC / DC24 |



## MINİ KONTAKTÖRLER

### MTMK SERİSİ



| Kutup Sayısı | In (A)<br>Anma Akımı | kW    | Kontakt   | Voltaj (V)      | Ürün Kodu       | Kutu Adedi | Koli Adedi | Fiyat (\$) |
|--------------|----------------------|-------|-----------|-----------------|-----------------|------------|------------|------------|
| 3P           | 6A                   | 2,2kW | 1NO       | 230V<br>AC      | MTMK10-3006     | 1          | 100        | 21,15 \$   |
|              | 9A                   | 4kW   | 1NO       |                 | MTMK10-3009     | 1          | 100        | 21,15 \$   |
|              | 12A                  | 5,5kW | 1NO       |                 | MTMK10-3012     | 1          | 100        | 23,85 \$   |
|              | 16A                  | 7,5kW | 1NO       |                 | MTMK10-3016     | 1          | 100        | 28,38 \$   |
|              | 6A                   | 2,2kW | 1NC       | 230V<br>AC      | MTMK01-3006     | 1          | 100        | 21,15 \$   |
|              | 9A                   | 4kW   | 1NC       |                 | MTMK01-3009     | 1          | 100        | 21,15 \$   |
|              | 12A                  | 5,5kW | 1NC       |                 | MTMK01-3012     | 1          | 100        | 23,85 \$   |
|              | 16A                  | 7,5kW | 1NC       |                 | MTMK01-3016     | 1          | 100        | 28,38 \$   |
|              | 6A                   | 2,2kW | 1NO       | 24V<br>DC       | MTMK10-3006DC24 | 1          | 100        | 36,54 \$   |
|              | 9A                   | 4kW   | 1NO       |                 | MTMK10-3009DC24 | 1          | 100        | 48,48 \$   |
|              | 12A                  | 5,5kW | 1NO       |                 | MTMK10-3012DC24 | 1          | 100        | 51,25 \$   |
|              | 16A                  | 7,5kW | 1NO       |                 | MTMK10-3016DC24 | 1          | 100        | 54,01 \$   |
| 6A           | 2,2kW                | 1NC   | 24V<br>DC | MTMK01-3006DC24 | 1               | 100        | 36,54 \$   |            |
| 9A           | 4kW                  | 1NC   |           | MTMK01-3009DC24 | 1               | 100        | 48,48 \$   |            |
| 12A          | 5,5kW                | 1NC   |           | MTMK01-3012DC24 | 1               | 100        | 51,25 \$   |            |
| 16A          | 7,5kW                | 1NC   |           | MTMK01-3016DC24 | 1               | 100        | 54,01 \$   |            |

## MINİ KONTAKTÖR YARDIMCI AKSESUARLARI

| Ürün Kodu       | Ürün Adı                              | Kutu Adedi | Koli Adedi | Fiyat (\$) |
|-----------------|---------------------------------------|------------|------------|------------|
| MTMKUX-UPBLOCKA | Mini Kontaktör Üst Blok A (1NO + 1NC) | 1          | 300        | 6,68 \$    |
| MTMKUX-UPBLOCKB | Mini Kontaktör Üst Blok B (2NO + 2NC) | 1          | 208        | 10,15 \$   |



## AC KOMPANZASYON KONTAKTÖRLERİ

### MTMAC SERİSİ



| Kutup Sayısı | kVAr    | Ürün Kodu  | Kutu Adedi | Koli Adedi | Fiyat (\$) |
|--------------|---------|------------|------------|------------|------------|
| 3P           | 7,5kVAr | MTMAC1-318 | 1          | 18         | 51,05 \$   |
|              | 12kVAr  | MTMAC1-325 | 1          | 18         | 65,37 \$   |
|              | 18kVAr  | MTMAC1-332 | 1          | 18         | 83,39 \$   |
|              | 20kVAr  | MTMAC1-343 | 1          | 20         | 84,09 \$   |
|              | 25kVAr  | MTMAC1-350 | 1          | 20         | 115,38 \$  |
|              | 30kVAr  | MTMAC1-365 | 1          | 20         | 143,23 \$  |
|              | 40kVAr  | MTMAC1-380 | 1          | 20         | 191,75 \$  |
|              | 50kVAr  | MTMAC1-395 | 1          | 20         | 228,71 \$  |
|              | 60kVAr  | MTMAC1-399 | 1          | 20         | 346,15 \$  |

|                                |                     |                   |  |
|--------------------------------|---------------------|-------------------|--|
| <b>MTMCO</b>                   | <b>Kutup Sayısı</b> | <b>Amper (A)</b>  | <b>Kontak</b>  |
| Modüler Kontaktör<br>Seri Kodu | 2/4                 | XXX<br>16A...100A | <b>11</b> : 1NO+1NC <b>31</b> : 3NO+1NC<br><b>20</b> : 2NO <b>13</b> : 1NO+3NC<br><b>02</b> : 2NC <b>40</b> : 4NO<br><b>22</b> : 2NO+2NC <b>04</b> : 4NC |

## MODÜLER KONTAKTÖRLER



### MTMCO SERİSİ

| Kutup Sayısı | In (A)<br>Anma Akımı | Kontak       | mm            | Ürün Kodu    | Kutu Adedi   | Koli Adedi | Fiyat (\$) |           |
|--------------|----------------------|--------------|---------------|--------------|--------------|------------|------------|-----------|
| 2P           | 16A                  | 1NO+1NC      | 18 mm         | MTMCO-201611 | 1            | 140        | 22,09 \$   |           |
|              | 16A                  | 2NO          |               | MTMCO-201620 | 1            | 140        | 22,09 \$   |           |
|              | 16A                  | 2NC          |               | MTMCO-201602 | 1            | 140        | 22,09 \$   |           |
|              | 25A                  | 1NO+1NC      |               | MTMCO-202511 | 1            | 140        | 24,89 \$   |           |
|              | 25A                  | 2NO          |               | MTMCO-202520 | 1            | 140        | 24,89 \$   |           |
|              | 25A                  | 2NC          |               | MTMCO-202502 | 140          | 24,89 \$   |            |           |
|              | 32A                  | 1NO+1NC      | 36 mm         | MTMCO-203211 | 1            | 70         | 45,19 \$   |           |
|              | 32A                  | 2NO          |               | MTMCO-203220 | 1            | 70         | 45,19 \$   |           |
|              | 32A                  | 2NC          |               | MTMCO-203202 | 1            | 70         | 45,19 \$   |           |
|              | 40A                  | 1NO+1NC      |               | MTMCO-204011 | 1            | 70         | 63,20 \$   |           |
|              | 40A                  | 2NO          |               | MTMCO-204020 | 1            | 70         | 63,20 \$   |           |
|              | 40A                  | 2NC          |               | MTMCO-204002 | 1            | 70         | 63,20 \$   |           |
|              | 63A                  | 1NO+1NC      | 54 mm         | MTMCO-206311 | 1            | 70         | 79,05 \$   |           |
|              | 63A                  | 2NO          |               | MTMCO-206320 | 1            | 70         | 79,05 \$   |           |
|              | 63A                  | 2NC          |               | MTMCO-206302 | 1            | 70         | 79,05 \$   |           |
|              | 80A                  | 1NO+1NC      |               | MTMCO-208011 | 1            | 50         | 96,24 \$   |           |
|              | 80A                  | 2NO          |               | MTMCO-208020 | 1            | 50         | 96,24 \$   |           |
|              | 80A                  | 2NC          |               | MTMCO-208002 | 1            | 50         | 96,24 \$   |           |
| 100A         | 1NO+1NC              | 54 mm        | MTMCO-2010011 | 1            | 50           | 96,24 \$   |            |           |
| 100A         | 2NO                  |              | MTMCO-2010020 | 1            | 50           | 96,24 \$   |            |           |
| 100A         | 2NC                  |              | MTMCO-2010002 | 1            | 50           | 96,24 \$   |            |           |
| 4P           | 16A                  |              | 2NO+2NC       | 36 mm        | MTMCO-401622 | 1          | 70         | 40,52 \$  |
|              | 16A                  |              | 3NO+1NC       |              | MTMCO-401631 | 1          | 70         | 40,52 \$  |
|              | 16A                  |              | 1NO+3NC       |              | MTMCO-401613 | 1          | 70         | 40,52 \$  |
|              | 16A                  | 4NO          | MTMCO-401640  |              | 1            | 70         | 40,52 \$   |           |
|              | 16A                  | 4NC          | MTMCO-401604  |              | 1            | 70         | 40,52 \$   |           |
|              | 25A                  | 2NO+2NC      | MTMCO-402522  |              | 1            | 70         | 42,31 \$   |           |
|              | 25A                  | 3NO+1NC      | MTMCO-402531  |              | 1            | 70         | 42,31 \$   |           |
|              | 25A                  | 1NO+3NC      | MTMCO-402513  |              | 1            | 70         | 42,31 \$   |           |
|              | 25A                  | 4NO          | MTMCO-402540  |              | 1            | 70         | 42,31 \$   |           |
|              | 25A                  | 4NC          | MTMCO-402504  |              | 1            | 70         | 42,31 \$   |           |
|              | 32A                  | 2NO+2NC      | 54 mm         | MTMCO-403222 | 1            | 50         | 56,56 \$   |           |
|              | 32A                  | 3NO+1NC      |               | MTMCO-403231 | 1            | 50         | 56,56 \$   |           |
|              | 32A                  | 1NO+3NC      |               | MTMCO-403213 | 1            | 50         | 56,56 \$   |           |
|              | 32A                  | 4NO          |               | MTMCO-403240 | 1            | 50         | 56,56 \$   |           |
|              | 32A                  | 4NC          |               | MTMCO-403204 | 1            | 50         | 56,56 \$   |           |
|              | 40A                  | 2NO+2NC      |               | MTMCO-404022 | 1            | 50         | 68,40 \$   |           |
|              | 40A                  | 3NO+1NC      |               | MTMCO-404031 | 1            | 50         | 68,40 \$   |           |
|              | 40A                  | 1NO+3NC      |               | MTMCO-404013 | 1            | 50         | 68,40 \$   |           |
|              | 40A                  | 4NO          |               | MTMCO-404040 | 1            | 50         | 68,40 \$   |           |
|              | 40A                  | 4NC          |               | MTMCO-404004 | 1            | 50         | 68,40 \$   |           |
|              | 63A                  | 2NO+2NC      | 54 mm         | MTMCO-406322 | 1            | 50         | 83,22 \$   |           |
|              | 63A                  | 3NO+1NC      |               | MTMCO-406331 | 1            | 50         | 83,22 \$   |           |
|              | 63A                  | 1NO+3NC      |               | MTMCO-406313 | 1            | 50         | 83,22 \$   |           |
|              | 63A                  | 4NO          |               | MTMCO-406340 | 1            | 50         | 83,22 \$   |           |
|              | 63A                  | 4NC          |               | MTMCO-406304 | 1            | 50         | 83,22 \$   |           |
|              | 80A                  | 2NO+2NC      |               | 108 mm       | MTMCO-408022 | 1          | 30         | 190,77 \$ |
|              | 80A                  | 3NO+1NC      |               |              | MTMCO-408031 | 1          | 30         | 190,77 \$ |
|              | 80A                  | 1NO+3NC      |               |              | MTMCO-408013 | 1          | 30         | 190,77 \$ |
|              | 80A                  | 4NO          |               |              | MTMCO-408040 | 1          | 30         | 190,77 \$ |
|              | 80A                  | 4NC          |               |              | MTMCO-408004 | 1          | 30         | 190,77 \$ |
| 100A         | 2NO+2NC              | MTMCO-410022 | 1             |              | 30           | 198,08 \$  |            |           |
| 100A         | 3NO+1NC              | MTMCO-410031 | 1             |              | 30           | 198,08 \$  |            |           |
| 100A         | 1NO+3NC              | MTMCO-410013 | 1             |              | 30           | 198,08 \$  |            |           |
| 100A         | 4NO                  | MTMCO-410040 | 1             |              | 30           | 198,08 \$  |            |           |
| 100A         | 4NC                  | MTMCO-410004 | 1             |              | 30           | 198,08 \$  |            |           |



## CE TERMİK RÖLELER

### MTTR SERİSİ



| Termik Ayar Sahası (A) | Ürün Kodu   | Kutu Adedi | Koli Adedi | Fiyat (\$) |
|------------------------|-------------|------------|------------|------------|
| 0,1 ~ 0,16A            | MTTR1-M1301 | 1          | 50         | 21,65 \$   |
| 0,16 ~ 0,25A           | MTTR1-M1302 | 1          | 50         | 21,65 \$   |
| 0,25 ~ 0,40A           | MTTR1-M1303 | 1          | 50         | 21,65 \$   |
| 0,40 ~ 0,63A           | MTTR1-M1304 | 1          | 50         | 21,65 \$   |
| 0,63 ~ 1A              | MTTR1-M1305 | 1          | 50         | 21,65 \$   |
| 1 ~ 1,6A               | MTTR1-M1306 | 1          | 50         | 21,65 \$   |
| 1,6 ~ 2,5A             | MTTR1-M1307 | 1          | 50         | 21,65 \$   |
| 2,5 ~ 4A               | MTTR1-M1308 | 1          | 50         | 21,65 \$   |
| 4 ~ 6A                 | MTTR1-M1310 | 1          | 50         | 21,65 \$   |
| 5,5 ~ 8A               | MTTR1-M1312 | 1          | 50         | 21,65 \$   |
| 7 ~ 10A                | MTTR1-M1314 | 1          | 50         | 21,65 \$   |
| 9 ~ 13A                | MTTR1-M1316 | 1          | 50         | 21,65 \$   |
| 12 ~ 18A               | MTTR1-M1321 | 1          | 50         | 21,65 \$   |
| 17 ~ 25A               | MTTR1-M1322 | 1          | 50         | 21,65 \$   |
| 23 ~ 32A               | MTTR2-M2353 | 1          | 75         | 32,39 \$   |
| 30 ~ 40A               | MTTR2-M2355 | 1          | 75         | 32,39 \$   |
| 17 ~ 25A <b>BÜYÜK</b>  | MTTR3-M3322 | 1          | 50         | 53,31 \$   |
| 23 ~ 32A <b>BÜYÜK</b>  | MTTR3-M3353 | 1          | 50         | 53,30 \$   |
| 30 ~ 40A <b>BÜYÜK</b>  | MTTR3-M3355 | 1          | 50         | 53,85 \$   |
| 37 ~ 50A               | MTTR3-M3357 | 1          | 50         | 55,77 \$   |
| 48 ~ 65A               | MTTR3-M3359 | 1          | 50         | 57,69 \$   |
| 55 ~ 70A               | MTTR3-M3361 | 1          | 50         | 64,62 \$   |
| 63 ~ 80A               | MTTR3-M3363 | 1          | 50         | 66,15 \$   |
| 80 ~ 93A               | MTTR3-M3365 | 1          | 50         | 71,15 \$   |

### TERMİK RÖLELER - BARALI



| Termik Ayar Sahası (A) | Ürün Kodu    | Kutu Adedi | Fiyat (\$)           |
|------------------------|--------------|------------|----------------------|
| 51 ~ 81A               | MTTR4-M4381  | 1          | <b>FİYAT SORUNUZ</b> |
| 62 ~ 99A               | MTTR4-M4399  | 1          |                      |
| 84 ~ 135A              | MTTR4-M43135 | 1          |                      |
| 124 ~ 198A             | MTTR5-M53198 | 1          |                      |
| 146 ~ 234A             | MTTR6-M63234 | 1          |                      |
| 174 ~ 279A             | MTTR6-M63279 | 1          |                      |

### TERMİK RÖLE RAY MONTAJ APARATLARI



| Ürün Kodu | Ürün Adı                           | Kutu Adedi | Koli Adedi | Fiyat (\$) |
|-----------|------------------------------------|------------|------------|------------|
| MTTRMB-1  | Ray Montaj Aparatı MTTR1 Kasa için | 1          | 100        | 5,80 \$    |
| MTTRMB-2  | Ray Montaj Aparatı MTTR2 Kasa için | 1          | 100        | 7,22 \$    |
| MTTRMB-3  | Ray Montaj Aparatı MTTR3 Kasa için | 1          | 30         | 17,70 \$   |

## MOTOR KORUMA ŞALTERLERİ

CE

MTPSO SERİSİ

| KW        | Termik Ayar Sahası (A) | Ürün Kodu    | Kutu Adedi | Koli Adedi | Fiyat (\$) |
|-----------|------------------------|--------------|------------|------------|------------|
| -         | 0,1 - 0,16A            | MTPSO-250016 | 1          | 50         | 42,60 \$   |
| 0.06      | 0,16 - 0,25A           | MTPSO-250025 | 1          | 50         | 42,60 \$   |
| 0.09      | 0,25 - 0,40A           | MTPSO-250040 | 1          | 50         | 42,60 \$   |
| 0.12-0.19 | 0,40 - 0,63A           | MTPSO-250063 | 1          | 50         | 45,03 \$   |
| 0.25      | 0,63-1A                | MTPSO-250100 | 1          | 50         | 45,03 \$   |
| 0.37-0.55 | 1 - 1,6A               | MTPSO-250160 | 1          | 50         | 45,03 \$   |
| 0.75      | 1,6 - 2,5A             | MTPSO-250250 | 1          | 50         | 45,03 \$   |
| 1.5       | 2,5 - 4A               | MTPSO-250400 | 1          | 50         | 45,03 \$   |
| 2.2       | 4 - 6,3A               | MTPSO-250630 | 1          | 50         | 46,88 \$   |
| 4         | 6 - 10A                | MTPSO-251000 | 1          | 50         | 46,88 \$   |
| 5.5       | 9 - 14A                | MTPSO-251400 | 1          | 50         | 47,46 \$   |
| 7.5       | 13 - 18A               | MTPSO-251800 | 1          | 50         | 48,61 \$   |
| 9         | 17 - 23A               | MTPSO-252300 | 1          | 50         | 49,89 \$   |
| 11        | 20 - 25A               | MTPSO-252500 | 1          | 50         | 49,89 \$   |
| 15        | 24 - 32A               | MTPSO-253200 | 1          | 50         | 73,85 \$   |
| 18.5      | 25 - 40A               | MTPS1-804000 | 1          | 50         | 140,05 \$  |
| 22        | 36 - 50A               | MTPS1-805000 | 1          | 50         | 173,08 \$  |
| 30        | 40 - 63A               | MTPS1-806300 | 1          | 50         | 173,08 \$  |
| 37        | 56 - 80A               | MTPS1-808000 | 1          | 50         | 207,18 \$  |



## MOTOR KORUMA ŞALTERİ AKSESUARLARI

| Ürün Kodu   | Ürün Adı  | Kutu Ad. | Koli Ad. | Fiyat (\$) |
|-------------|---|----------|----------|------------|
| MTPSO-F11   | 1NO+1NC Yardımcı Kontak - Üstten Montajlı (MTPSO Kasa için) | 1        | 1000     | 9,25 \$    |
| MTPSO-F20   | 2NO Yardımcı Kontak - Üstten Montajlı (MTPSO Kasa için)     | 1        | 1000     | 9,27 \$    |
| MTPSO-L11   | 1NO+1NC Yardımcı Kontak - Yandan Montajlı (MTPSO Kasa için) | 1        | 500      | 14,47 \$   |
| MTPSO-L20   | 2NO Yardımcı Kontak - Yandan Montajlı (MTPSO Kasa için)     | 1        | 500      | 14,46 \$   |
| MTPS1-L11   | 1NO+1NC Yardımcı Kontak - Yandan Montajlı (MTPS1 Kasa için) | 1        | 500      | 19,23 \$   |
| MTPS1-L20   | 2NO Yardımcı Kontak - Yandan Montajlı (MTPS1 Kasa için)     | 1        | 500      | 19,23 \$   |
| MTPSO-AB    | Açtırma Bobini (MTPSO Kasa için)                            | 1        | 500      | 17,31 \$   |
| MTPSO-DG    | 400V Düşük Gerilim Açtırma Bobini (MTPSO Kasa için)         | 1        | 300      | 26,92 \$   |
| MTPSO-IP55K | IP55 Kutu (MTPSO Kasa için)                                 | 1        | 50       | 19,23 \$   |



## MOTOR DEVRELERİNDE SEÇİM TABLOSU

### DİREKT YOL VERME, 0.06-37 kW AC3 SINIFINDA, 3 FAZLI 50/60 Hz

| Motorların Standart Güç Değerleri |      | Motor Koruma Şalteri Referans Kodu | Termik Röle Referans Kodu | Kontaktör Referans Kodu |
|-----------------------------------|------|------------------------------------|---------------------------|-------------------------|
| kW                                | A    |                                    | Ayar Sahası (A)           |                         |
| 0.06                              | 0.22 | MTP50-250025                       | 0.16 ~ 0.25               | MTMAXX-3009             |
| 0.09                              | 0.36 | MTP50-250040                       | 0.25 ~ 0.40               | MTMAXX-3009             |
| 0.12                              | 0.42 | MTP50-250063                       | 0.40 ~ 0.63               | MTMAXX-3009             |
| 0.18                              | 0.6  | MTP50-250063                       | 0.40 ~ 0.63               | MTMAXX-3009             |
| 0.25                              | 0.88 | MTP50-250100                       | 0.63 ~ 1                  | MTMAXX-3009             |
| 0.37                              | 0.98 | MTP50-250100                       | 0.63 ~ 1                  | MTMAXX-3009             |
| 0.55                              | 1.5  | MTP50-250160                       | 0.16 ~ 0.25               | MTMAXX-3009             |
| 0.75                              | 2    | MTP50-250250                       | 1 ~ 1.6                   | MTMAXX-3009             |
| 1.1                               | 2.5  | MTP50-250400                       | 2.5 ~ 4                   | MTMAXX-3009             |
| 1.5                               | 3.5  | MTP50-250400                       | 2.5 ~ 4                   | MTMAXX-3009             |
| 2.2                               | 5    | MTP50-250630                       | 4 ~ 6                     | MTMAXX-3009             |
| 3                                 | 6.5  | MTP50-251000                       | 7 ~ 10                    | MTMAXX-3009             |
| 4                                 | 8.4  | MTP50-251000                       | 7 ~ 10                    | MTMAXX-3009             |
| 5.5                               | 11   | MTP50-251400                       | 9 ~ 13                    | MTMAXX-3012             |
| 7.5                               | 14.8 | MTP50-251800                       | 12 ~ 18                   | MTMAXX-3018             |
| 9                                 | 18.1 | MTP50-252300                       | 17 ~ 25                   | MTMAXX-3025             |
| 11                                | 21   | MTP50-252500                       | 17 ~ 25                   | MTMAXX-3025             |
| 15                                | 28.5 | MTP50-253200                       | 23 ~ 32                   | MTMA11-3032             |
| 18.5                              | 35   | MTP50-804000                       | 30 ~ 40                   | MTMA11-3040             |
| 22                                | 41   | MTP50-805000                       | 37 ~ 50                   | MTMA11-3050             |
| 30                                | 55   | MTP50-806300                       | 48 ~ 65                   | MTMA11-3065             |
| 37                                | 69   | MTP50-808000                       | 55 ~ 70                   | MTMA11-3080             |

**XX = 01 (1NC)**  
**XX = 10 (1NO)**  
**XX = 11 (1NO+1NC)**

\* Yukarıdaki değerler rehber niteliğinde verilmiştir. Motor tipine ve üreticisine göre değişiklik gösterebilir.

## Stella | Alessa

### Renkler



01 - BEYAZ

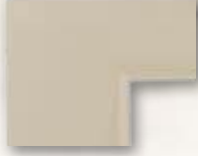

02 - KREM



62 - METALİK SİYAH



80 - ANTİK ALTIN



84 - SİYAH



86 - ANTRASİT



88 - SU YEŞİLİ



92 - ANTİK GÜMÜŞ



95 - FÜME



97 - SATEN BEJ

XX = Renk Kodlarının Karşılığıdır.

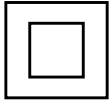

2M

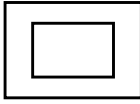

3M

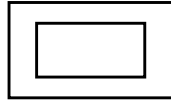

4M

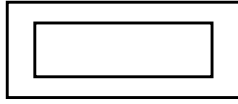

7M

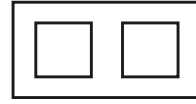

2x2M

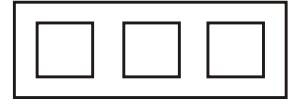

3x2M



## Stella

| Kod               | Ürün Tanımı              | Kutu Adedi | Koli Adedi | Beyaz/Krem Fiyat (₺) | Renkli Fiyat (₺) |
|-------------------|--------------------------|------------|------------|----------------------|------------------|
| <b>Çerçeveler</b> |                          |            |            |                      |                  |
| 2440 800 12XX     | Stella 2M Çerçeve        | 20         | -          | 124,43               | 181,82           |
| 2440 800 13XX     | Stella 3M Çerçeve        | 20         | -          | 184,34               | 227,27           |
| 2440 800 14XX     | Stella 4M Çerçeve        | 10         | -          | 221,23               | 272,73           |
| 2440 800 17XX     | Stella 7M Çerçeve        | 10         | -          | 271,04               | 409,09           |
| 2430 800 12XX     | Stella Plus 2x2M Çerçeve | 10         | -          | 292,79               | 500,00           |
| 2430 800 13XX     | Stella Plus 3x2M Çerçeve | 10         | -          | 383,37               | 727,27           |

## Alessa

| Kod                           | Ürün Tanımı                            | Kutu Adedi | Koli Adedi | Beyaz/Krem Fiyat (₺) | Renkli Fiyat (₺) |
|-------------------------------|--|------------|------------|----------------------|------------------|
| <b>Beyaz Fonlu Çerçeveler</b> |  |            |            |                      |                  |
| 2420 801 12XX                 | Alessa 2M Çerçeve - Beyaz Fonlu        | 20         | -          | 209,09               | 318,18           |
| 2420 801 13XX                 | Alessa 3M Çerçeve - Beyaz Fonlu        | 20         | -          | 240,91               | 363,64           |
| 2420 801 14XX                 | Alessa 4M Çerçeve - Beyaz Fonlu        | 10         | -          | 300,00               | 409,09           |
| 2420 801 17XX                 | Alessa 7M Çerçeve - Beyaz Fonlu        | 10         | -          | 363,64               | 500,00           |
| 2450 801 12XX                 | Alessa Plus 2x2M Çerçeve - Beyaz Fonlu | 10         | -          | 386,69               | 636,36           |
| 2450 801 13XX                 | Alessa Plus 3x2M Çerçeve - Beyaz Fonlu | 10         | -          | 533,00               | 818,18           |

## Alessa

| Kod                           | Ürün Tanımı                            | Kutu Adedi | Koli Adedi | Beyaz/Krem Fiyat (₺) | Renkli Fiyat (₺) |
|-------------------------------|--|------------|------------|----------------------|------------------|
| <b>Siyah Fonlu Çerçeveler</b> |  |            |            |                      |                  |
| 2420 811 12XX                 | Alessa 2M Çerçeve - Siyah Fonlu        | 20         | -          | 209,09               | 318,18           |
| 2420 811 13XX                 | Alessa 3M Çerçeve - Siyah Fonlu        | 20         | -          | 240,91               | 363,64           |
| 2420 811 14XX                 | Alessa 4M Çerçeve - Siyah Fonlu        | 10         | -          | 300,00               | 409,09           |
| 2420 811 17XX                 | Alessa 7M Çerçeve - Siyah Fonlu        | 10         | -          | 363,64               | 500,00           |
| 2450 811 12XX                 | Alessa Plus 2x2M Çerçeve - Siyah Fonlu | 10         | -          | 366,76               | 636,36           |
| 2450 811 13XX                 | Alessa Plus 3x2M Çerçeve - Siyah Fonlu | 10         | -          | 504,02               | 818,18           |



Buat Kasa



Karkas



2M Modül



1M Modül



Dekoratif Çerçeve



## MODÜLLER

| Kod                       | Ürün Tanımı                          | Kutu Adedi | Koli Adedi | Fiyat (₺) |
|---------------------------|--------------------------------------|------------|------------|-----------|
| 2400 701 0200             | Anahtar (1M)                         | 20         | 120        | 227,27    |
| 2400 703 0200             | Vavien (1M)                          | 20         | 120        | 227,27    |
| 2400 708 0200             | Ara Vavien(Deviatör)(Permütatör)(1M) | 20         | 120        | 363,64    |
| 2400 705 0200             | Çift Kutuplu Anahtar (1M)            | 20         | 120        | 354,55    |
| 2400 707 0200             | Light Butonu (1M)                    | 20         | 120        | 250,00    |
| 2400 707 0200Z            | Zil Butonu (1M)                      | 20         | 120        | 250,00    |
| 2400 707 0200K            | Kapı Otomatiği (1M)                  | 20         | 120        | 250,00    |
| <b>YENİ</b> 2400 706 0200 | Stor/Panjur (Jaluzi - Yaylı) (1M)    | 20         | 120        | 545,45    |
| <b>YENİ</b> 2400 436 0200 | Stor/Panjur (Jaluzi - Yaysız) (1M)   | 20         | 120        | 545,45    |

| Kod                       | Ürün Tanımı                      | Kutu Adedi | Koli Adedi | Beyaz/Krem Fiyat (₺) | Renkli Fiyat (₺) |
|---------------------------|----------------------------------|------------|------------|----------------------|------------------|
| <b>YENİ</b> 2400 472 02XX | DND/MUR Anahtar Modül + Tuş (2M) | 10         | 60         | 863,64               | 1.000,00         |

| Kod           | Ürün Tanımı                           | Kutu Adedi | Koli Adedi | Beyaz/Krem Fiyat (₺) | Renkli Fiyat (₺) |
|---------------|---------------------------------------|------------|------------|----------------------|------------------|
| 2400 900 02XX | Topraklı Priz (2M)                    | 10         | 60         | 250,00               | 363,64           |
| 2400 905 02XX | Topraklı Priz (Çocuk Korumalı) (2M)   | 10         | 60         | 272,73               | 409,09           |
| 2400 910 02XX | Kapaklı Topraklı Priz (2M)            | 10         | 60         | 272,73               | 431,82           |
| 2400 911 02XX | Kapaklı Topraklı Priz (Çoc.Kor.) (2M) | 10         | 60         | 290,91               | 454,55           |

| Kod                       | Ürün Tanımı                                 | Kutu Adedi | Koli Adedi | Beyaz/Krem Fiyat (₺) | Renkli Fiyat (₺) |
|---------------------------|---|------------|------------|----------------------|------------------|
| 2400 916 02XX             | Ups ( Fransız) Priz (Çoc. Kor.) (2M)        | 10         | 60         | 318,18               | 431,82           |
| 2400 917 02XX             | Ups (Fransız) Kapaklı Priz (2M)             | 10         | 60         | 340,91               | 454,55           |
| <b>YENİ</b> 2400 918 02XX | Ups (Fransız) Kapaklı Priz (Çoc. Kor.) (2M) | 10         | 60         | 375,00               | 485,00           |

| Kod           | Ürün Tanımı         | Kutu Adedi | Koli Adedi | Beyaz/Krem Fiyat (₺) | Renkli Fiyat (₺) |
|---------------|---------------------|------------|------------|----------------------|------------------|
| 2400 925 02XX | Universal Priz (1M) | 20         | 120        | 454,55               | 545,45           |
| 2400 560 02XX | Universal Priz (2M) | 10         | 60         | 863,64               | 909,09           |

| Kod           | Ürün Tanımı                                      | Kutu Adedi | Koli Adedi | Beyaz/Krem Fiyat (₺) | Renkli Fiyat (₺) |
|---------------|--|------------|------------|----------------------|------------------|
| 2400 450 02XX | Stella Energy Saver Gecikmesiz Switch 220V (2M)  | 6          | 36         | 1.636,36             | 1.800,00         |
| 2400 452 02XX | Stella Energy Saver Gecikmeli Switch 220V (2M)   | 6          | 36         | 1.636,36             | 1.800,00         |
| 2400 462 02XX | Stella Energy Saver Gecikmesiz Switch 12V (2M)   | 6          | 36         | 1.818,18             | 2.000,00         |
| 2400 464 02XX | Stella Energy Saver Gecikmeli Switch 12V (2M)    | 6          | 36         | 1.818,18             | 2.000,00         |
| 2400 466 02XX | Stella Energy Saver Gecikmesiz 13.56 RF 12V (2M) | 6          | 36         | 2.045,45             | 2.250,00         |
| 2400 468 02XX | Stella Energy Saver Gecikmeli 13.56 RF 12V (2M)  | 6          | 36         | 2.045,45             | 2.250,00         |
| 2400 650 02XX | Alessa Energy Saver Gecikmesiz Switch 220V (2M)  | 6          | 36         | 1.636,36             | 1.800,00         |
| 2400 652 02XX | Alessa Energy Saver Gecikmeli Switch 220V (2M)   | 6          | 36         | 1.636,36             | 1.800,00         |
| 2400 662 02XX | Alessa Energy Saver Gecikmesiz Switch 12V (2M)   | 6          | 36         | 1.818,18             | 2.000,00         |
| 2400 664 02XX | Alessa Energy Saver Gecikmeli Switch 12V (2M)    | 6          | 36         | 1.818,18             | 2.000,00         |
| 2400 666 02XX | Alessa Energy Saver Gecikmesiz 13.56 RF 12V (2M) | 6          | 36         | 2.045,45             | 2.250,00         |
| 2400 668 02XX | Alessa Energy Saver Gecikmeli 13.56 RF 12V (2M)  | 6          | 36         | 2.045,45             | 2.250,00         |
| 2400 465 0201 | 4 Kanallı Röle Modülü                            | 6          | 36         | 5.227,27             | -                |

| Kod           | Ürün Tanımı            | Kutu Adedi | Koli Adedi | Beyaz/Krem Fiyat (₺) | Renkli Fiyat (₺) |
|---------------|------------------------|------------|------------|----------------------|------------------|
| 2400 550 02XX | İngiliz Tipi Priz (2M) | 10         | 60         | 704,55               | 810,23           |

| Kod           | Ürün Tanımı                        | Kutu Adedi | Koli Adedi | Beyaz/Krem Fiyat (₺) | Renkli Fiyat (₺) |
|---------------|------------------------------------|------------|------------|----------------------|------------------|
| 2400 469 02XX | USB + Tip-C Şarj Prizi PD 20W (2M) | 10         | 60         | 1.681,82             | 2.000,00         |

| Kod           | Ürün Tanımı       | Kutu Adedi | Koli Adedi | Beyaz/Krem Fiyat (₺) | Renkli Fiyat (₺) |
|---------------|-------------------|------------|------------|----------------------|------------------|
| 2400 920 02XX | İtalyan Priz (1M) | 20         | 120        | 272,73               | 318,18           |





## MODÜLLER

| Kod           | Ürün Tanımı               | Kutu Adedi | Koli Adedi | Beyaz/Krem Fiyat (₺) | Renkli Fiyat (₺) |
|---------------|---------------------------|------------|------------|----------------------|------------------|
| 2400 441 02XX | Dimmer 100 - 500W (1M) RC | 20         | 120        | <b>2.136,36</b>      | <b>2.350,00</b>  |
| 2400 541 02XX | Dimmer 100 - 500W (1M) RL | 20         | 120        | <b>1.636,36</b>      | <b>1.800,00</b>  |



| Kod           | Ürün Tanımı               | Kutu Adedi | Koli Adedi | Beyaz/Krem Fiyat (₺) | Renkli Fiyat (₺) |
|---------------|---------------------------|------------|------------|----------------------|------------------|
| 2400 442 02XX | Dimmer 100 - 500W (2M) RC | 10         | 60         | <b>2.272,73</b>      | <b>2.500,00</b>  |
| 2400 542 02XX | Dimmer 100 - 500W (2M) RL | 10         | 60         | <b>1.681,82</b>      | <b>1.850,00</b>  |



| Kod           | Ürün Tanımı             | Kutu Adedi | Koli Adedi | Beyaz/Krem Fiyat (₺) | Renkli Fiyat (₺) |
|---------------|-------------------------|------------|------------|----------------------|------------------|
| 2400 171 02XX | Tv Prizi (Sonlu) (1M)   | 20         | 120        | <b>909,09</b>        | <b>1.090,91</b>  |
| 2400 170 02XX | Tv Prizi (Geçişli) (1M) | 20         | 120        | <b>909,09</b>        | <b>1.090,91</b>  |



| Kod           | Ürün Tanımı          | Kutu Adedi | Koli Adedi | Beyaz/Krem Fiyat (₺) | Renkli Fiyat (₺) |
|---------------|----------------------|------------|------------|----------------------|------------------|
| 2400 172 02XX | Tv Prizi F Dişi (1M) | 20         | 120        | <b>386,36</b>        | <b>431,82</b>    |



| Kod                       | Ürün Tanımı                | Kutu Adedi | Koli Adedi | Beyaz/Krem Fiyat (₺) | Renkli Fiyat (₺) |
|---------------------------|----------------------------|------------|------------|----------------------|------------------|
| 2400 125 02XX             | Telefon Prizi (Cat3) (1M)  | 20         | 120        | <b>386,36</b>        | <b>425,00</b>    |
| 2400 140 02XX             | Data Prizi (Cat6) (1M)     | 20         | 120        | <b>409,09</b>        | <b>450,00</b>    |
| <b>YENİ</b> 2400 147 01XX | 1 Çıkışlı Fiber Optik Priz | 20         | 120        | <b>418,18</b>        | <b>460,00</b>    |
| <b>YENİ</b> 2400 457 02XX | HDMI Priz                  | 20         | 120        | <b>681,82</b>        | <b>750,00</b>    |



| Kod           | Ürün Tanımı          | Kutu Adedi | Koli Adedi | Beyaz/Krem Fiyat (₺) | Renkli Fiyat (₺) |
|---------------|----------------------|------------|------------|----------------------|------------------|
| 2400 482 02XX | RCA Çıkışı 2'li (1M) | 20         | 120        | <b>363,64</b>        | <b>386,36</b>    |



| Kod           | Ürün Tanımı    | Kutu Adedi | Koli Adedi | Beyaz/Krem Fiyat (₺) | Renkli Fiyat (₺) |
|---------------|----------------|------------|------------|----------------------|------------------|
| 2400 121 02XX | Kör Kapak (1M) | 20         | 120        | <b>90,91</b>         | <b>136,36</b>    |



| Kod           | Ürün Tanımı | Kutu Adedi | Koli Adedi | Fiyat (₺)     |
|---------------|-------------|------------|------------|---------------|
| 2400 000 0001 | Mavi Lamba  |            | 50         | -             |
|               |             |            |            | <b>136,36</b> |

## TUŞLAR

| Kod           | Ürün Tanımı    | Kutu Adedi | Koli Adedi | Beyaz/Krem Fiyat (₺) | Renkli Fiyat (₺) |
|---------------|----------------|------------|------------|----------------------|------------------|
| 2410 701 01XX | 1M Anahtar Tuş | 40         | -          | 36,36                | 113,64           |
| 2410 701 02XX | 2M Anahtar Tuş | 20         | -          | 90,91                | 145,45           |

| Kod           | Ürün Tanımı   | Kutu Adedi | Koli Adedi | Beyaz/Krem Fiyat (₺) | Renkli Fiyat (₺) |
|---------------|---------------|------------|------------|----------------------|------------------|
| 2410 703 01XX | 1M Vavien Tuş | 40         | -          | 36,36                | 113,64           |
| 2410 703 02XX | 2M Vavien Tuş | 20         | -          | 90,91                | 145,45           |

| Kod           | Ürün Tanımı       | Kutu Adedi | Koli Adedi | Beyaz/Krem Fiyat (₺) | Renkli Fiyat (₺) |
|---------------|-------------------|------------|------------|----------------------|------------------|
| 2410 708 01XX | 1M Ara Vavien Tuş | 40         | -          | 36,36                | 113,64           |
| 2410 708 02XX | 2M Ara Vavien Tuş | 20         | -          | 90,91                | 145,45           |

| Kod           | Ürün Tanımı          | Kutu Adedi | Koli Adedi | Beyaz/Krem Fiyat (₺) | Renkli Fiyat (₺) |
|---------------|----------------------|------------|------------|----------------------|------------------|
| 2410 707 01XX | 1M Çağırma Light Tuş | 40         | -          | 36,36                | 113,64           |
| 2410 707 02XX | 2M Çağırma Light Tuş | 20         | -          | 90,91                | 145,45           |

| Kod            | Ürün Tanımı        | Kutu Adedi | Koli Adedi | Beyaz/Krem Fiyat (₺) | Renkli Fiyat (₺) |
|----------------|--------------------|------------|------------|----------------------|------------------|
| 2410 707 01XXZ | 1M Zil Anahtar Tuş | 40         | -          | 36,36                | 113,64           |
| 2410 707 02XXZ | 2M Zil Anahtar Tuş | 20         | -          | 90,91                | 145,45           |

| Kod            | Ürün Tanımı           | Kutu Adedi | Koli Adedi | Beyaz/Krem Fiyat (₺) | Renkli Fiyat (₺) |
|----------------|-----------------------|------------|------------|----------------------|------------------|
| 2410 707 01XXX | 1M Kapı Otomatığı Tuş | 40         | -          | 36,36                | 113,64           |
| 2410 707 02XXX | 2M Kapı Otomatığı Tuş | 20         | -          | 90,91                | 145,45           |

| Kod           | Ürün Tanımı           | Kutu Adedi | Koli Adedi | Beyaz/Krem Fiyat (₺) | Renkli Fiyat (₺) |
|---------------|-----------------------|------------|------------|----------------------|------------------|
| 2410 715 01XX | 1M Işıklı Anahtar Tuş | 40         | -          | 36,36                | 113,64           |
| 2410 715 02XX | 2M Işıklı Anahtar Tuş | 20         | -          | 90,91                | 145,45           |

| Kod           | Ürün Tanımı                  | Kutu Adedi | Koli Adedi | Beyaz/Krem Fiyat (₺) | Renkli Fiyat (₺) |
|---------------|------------------------------|------------|------------|----------------------|------------------|
| 2410 716 01XX | 1M Işıklı Vavien Anahtar Tuş | 40         | -          | 36,36                | 113,64           |
| 2410 716 02XX | 2M Işıklı Vavien Anahtar Tuş | 20         | -          | 90,91                | 145,45           |

| Kod           | Ürün Tanımı                 | Kutu Adedi | Koli Adedi | Beyaz/Krem Fiyat (₺) | Renkli Fiyat (₺) |
|---------------|-----------------------------|------------|------------|----------------------|------------------|
| 2410 717 01XX | 1M Çağırma Light Işıklı Tuş | 40         | -          | 36,36                | 113,64           |
| 2410 717 02XX | 2M Çağırma Light Işıklı Tuş | 20         | -          | 90,91                | 145,45           |

| Kod            | Ürün Tanımı               | Kutu Adedi | Koli Adedi | Beyaz/Krem Fiyat (₺) | Renkli Fiyat (₺) |
|----------------|---------------------------|------------|------------|----------------------|------------------|
| 2410 717 01XXZ | 1M Işıklı Zil Anahtar Tuş | 40         | -          | 36,36                | 113,64           |
| 2410 717 02XXZ | 2M Işıklı Zil Anahtar Tuş | 20         | -          | 90,91                | 145,45           |

| Kod            | Ürün Tanımı                | Kutu Adedi | Koli Adedi | Beyaz/Krem Fiyat (₺) | Renkli Fiyat (₺) |
|----------------|----------------------------|------------|------------|----------------------|------------------|
| 2410 717 01XXX | 1M Işıklı Kapı Anahtar Tuş | 40         | -          | 36,36                | 113,64           |
| 2410 717 02XXX | 2M Işıklı Kapı Anahtar Tuş | 20         | -          | 90,91                | 145,45           |

| Kod           | Ürün Tanımı   | Kutu Adedi | Koli Adedi | Beyaz/Krem Fiyat (₺) | Renkli Fiyat (₺) |
|---------------|---------------|------------|------------|----------------------|------------------|
| 2410 706 01XX | 1M Jaluzi Tuş | 40         | -          | 36,36                | 113,64           |





## KARKASLAR

| Kod           | Ürün Tanımı | Kutu Adedi | Koli Adedi | Fiyat (₺) |
|---------------|-------------|------------|------------|-----------|
| 2400 500 0217 | Karkas (2M) | 10         | -          | 113,64    |
| 2400 500 0317 | Karkas (3M) | 10         | -          | 136,36    |
| 2400 500 0417 | Karkas(4M)  | 10         | -          | 145,45    |
| 2400 500 0717 | Karkas (7M) | 10         | -          | 204,55    |



## SIVA ALTI BUAT KASALAR

| Kod                  | Ürün Tanımı                              | Kutu Adedi | Koli Adedi | Fiyat (₺) |
|----------------------|--|------------|------------|-----------|
| 001 046 180101 00 12 | Çift Kilitlemeli Geçmeli Derin Kasa (2M) | 300        | -          | 38,64     |
| 2400 812 1315        | Sıva Altı Buat Kasa (3M)                 | 165        | -          | 76,07     |
| 2400 812 1415        | Sıva Altı Buat Kasa (4M)                 | 135        | -          | 106,02    |
| 2400 812 1715        | Sıva Altı Buat Kasa (7M)                 | 90         | -          | 135,90    |

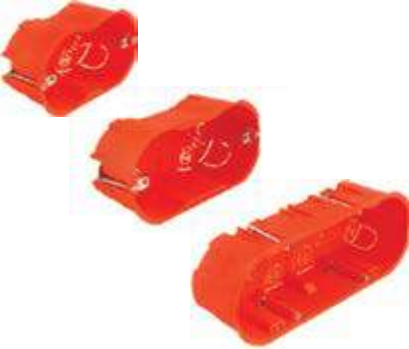

## ALÇIPAN KASA

| Kod           | Ürün Tanımı       | Kutu Adedi | Koli Adedi | Fiyat (₺) |
|---------------|-------------------|------------|------------|-----------|
| 2400 813 1312 | Alçıpan Kasa (3M) | 180        | -          | 136,36    |
| 2400 813 1412 | Alçıpan Kasa (4M) | 150        | -          | 172,73    |
| 2400 813 1712 | Alçıpan Kasa (7M) | 114        | -          | 286,36    |



## SIVA ALTI BAĞLANTI APARATI

| Kod           | Ürün Tanımı                | Kutu Adedi | Koli Adedi | Fiyat (₺) |
|---------------|----------------------------|------------|------------|-----------|
| 2400 818 0011 | Sıva Altı Bağlantı Aparatı | 40         | -          | 30,14     |



Altın  
80



Bronz  
87

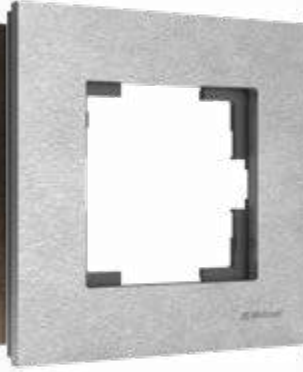

Gümüş  
92



Siyah  
84

## ALÜMİNYUM ÇERÇEVELER

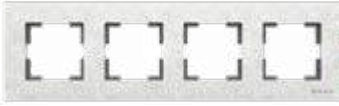

| Kod           | Ürün Tanımı          | Kutu Adedi | Fiyat (₺) |
|---------------|----------------------|------------|-----------|
| 2225 800 11XX | Tekli Çerçeve        | 10         | 852,27    |
| 2225 800 12XX | Yatay İkili Çerçeve  | 10         | 1.136,36  |
| 2225 800 13XX | Yatay Üçlü Çerçeve   | 10         | 1.846,59  |
| 2225 800 14XX | Yatay Dörtlü Çerçeve | 10         | 2.556,82  |
| 2225 800 15XX | Yatay Beşli Çerçeve  | 10         | 3.409,09  |
| 2225 800 22XX | Dikey İkili Çerçeve  | 10         | 1.136,36  |
| 2225 800 23XX | Dikey Üçlü Çerçeve   | 10         | 1.846,59  |
| 2225 800 24XX | Dikey Dörtlü Çerçeve | 10         | 2.556,82  |
| 2225 800 25XX | Dikey Beşli Çerçeve  | 10         | 3.409,09  |



Beyaz  
20



Siyah  
21



Antrasit  
22



Kese Kağıdı  
23

## PLEKSİ ÇERÇEVELER

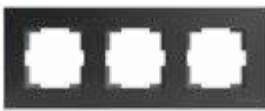
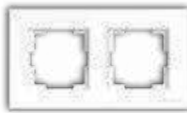

| Kod           | Ürün Tanımı          | Kutu Adedi | Fiyat (₺) |
|---------------|----------------------|------------|-----------|
| 2222 800 11XX | Tekli Çerçeve        | 10         | 681,82    |
| 2222 800 12XX | Yatay İkili Çerçeve  | 10         | 909,09    |
| 2222 800 13XX | Yatay Üçlü Çerçeve   | 10         | 1.477,27  |
| 2222 800 14XX | Yatay Dörtlü Çerçeve | 10         | 2.045,45  |
| 2222 800 15XX | Yatay Beşli Çerçeve  | 10         | 2.727,27  |
| 2222 800 22XX | Dikey İkili Çerçeve  | 10         | 909,09    |
| 2222 800 23XX | Dikey Üçlü Çerçeve   | 10         | 1.477,27  |
| 2222 800 24XX | Dikey Dörtlü Çerçeve | 10         | 2.045,45  |
| 2222 800 25XX | Dikey Beşli Çerçeve  | 10         | 2.727,27  |

## ANAHTAR GRUBU - VİDALI TİP



**2220 401 02XX**  
Anahtar



**2220 402 02XX**  
Komütatör



**2220 403 02XX**  
Vavien (İki yöllü anahtar)



**2220 404 02XX**  
Komütatör Vavien



**2220 405 02XX**  
Çift Kutuplu Anahtar

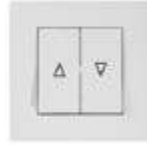

**2220 406 02XX**  
Jaluzi Anahtar



**2220 407 02XX**  
Çağırma



**2220 407 02XXK**  
Kapı Otomatığı



**2220 407 02XXZ**  
Zil Anahtar



**2220 408 02XX**  
Deviyatör (Ara Vavien)



**2220 409 02XX**  
Üçlü Anahtar



**2220 411 02XX**  
Şofben Anahtar



**2220 415 02XX**  
Işıklı Anahtar (220V)



**2220 416 02XX**  
Işıklı Vavien (220V)



**2220 417 02XX**  
Işıklı Çağırma (220V)



**2220 418 02XX**  
Işıklı Etiketli Anahtar (220V)



**2220 419 02XX**  
Işıklı Etiketli Çağırma (220V)



**2220 422 02XX**  
Işıklı Zil Etiketli Çağırma (12V)

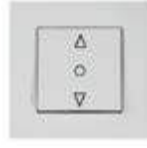

**2220 425 02XX**  
Tek Tuşlu Jaluzi Anahtar



**2220 426 02XX**  
Işıklı Komitatör



**2220 436 02XX**  
Tek Tuşlu Jaluzi Anahtar (Yaysız-Vıdalı)

## ANAHTAR GRUBU - KLİPSLİ TİP (KOLAY BAĞLANTI)



**2220 401 01XX**  
Anahtar



**2220 402 01XX**  
Komütatör



**2220 403 01XX**  
Vavien (İki yöllü anahtar)



**2220 404 01XX**  
Komütatör Vavien



**2220 405 01XX**  
Çift Kutuplu Anahtar

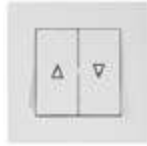

**2220 406 01XX**  
Jaluzi Anahtar



**2220 407 01XX**  
Çağırma



**2220 407 01XXK**  
Kapı Otomatığı



**2220 407 01XXZ**  
Zil Anahtar



**2220 408 01XX**  
Deviyatör (Ara Vavien)



**2220 409 01XX**  
Üçlü Anahtar



**2220 415 01XX**  
Işıklı Anahtar (220V)



**2220 416 01XX**  
Işıklı Vavien (220V)



**2220 417 01XX**  
Işıklı Çağırma (220V)



**2220 418 01XX**  
Işıklı Etiketli Anahtar (220V)



**2220 419 01XX**  
Işıklı Etiketli Çağırma (220V)



**2220 422 01XX**  
Işıklı Zil Etiketli Çağırma (12V)



**2220 426 01XX**  
Işıklı Komitatör



**2220 436 01XX**  
Tek Tuşlu Jaluzi Anahtar (Yaysız-Vıdalı)

## ELEKTRONİK GRUBU



**2220 250 01XX**  
Speakphone Prizi



**2220 251 01XX**  
RCA Prizi



**2220 252 01XX**  
3,5 Ses Jakı



**2220 253 01XX**  
XLR Erkek Prizi



**2220 254 01XX**  
XLR Dişi Prizi



**2220 255 01XX**  
USB Priter Prizi



**2220 450 01XX**  
Energy Saver Gecikmesiz Işıklı



**2220 452 01XX**  
Energy Saver Gecikmeli Işıklı



**2220 454 01XX**  
Temassız Anahtar



**2220 470 02XX**  
Müzik Yayın Anahtar



**2220 480 01XX**  
Hoparlör Prizi



**2220 485 02XX**  
Uyarı Zili



**2220 495 02XX**  
Hareket Sensörü

## PRİZ GRUBU



**2220 600 02XX**  
Topraklı Priz



**2220 601 02XX**  
Topraksız Priz



**2220 605 02XX**  
Topraklı Priz (Ç.K)



**2220 606 02XX**  
Topraksız Priz (Ç.K)



**2220 610 02XX**  
Kapaklı Topraklı Priz



**2220 611 02XX**  
Kapaklı Topraklı Priz (Ç.K)



**2220 615 02XX**  
Ups (Fransız) Prizi



**2220 616 02XX**  
Ups (Fransız) Prizi (Ç.K)



**2220 617 02XX**  
Ups Kapaklı (Fransız) Prizi



**2220 618 02XX**  
Ups Kapaklı (Fransız) Prizi (Ç.K)



**2220 448 01XX**  
Tekli USB Şarj Prizi



**2220 469 01XX**  
İkili USB Şarj Prizi



**2220 200 02XX**  
İkili Topraklı Priz Porselen



**2220 201 02XX**  
İkili Topraksız Priz Porselen



**2220 202 02XX**  
İkili Topraklı Priz



**2220 203 02XX**  
İkili Topraksız Priz



**2220 215 01XX**  
İkili UPS Priz



**2220 629 02XX**  
Usb + Type C Topraklı Priz

## İLETİŞİM GRUBU



**2220 125 01XX**  
Telefon Prizi 1XRj11 (Cat3)



**2220 126 01XX**  
Telefon Prizi 2XRj11 (Cat3)



**2220 128 01XX**  
Etiketli Telefon Data Prizi (Konnektörsüz)



**2220 135 01XX**  
Data Prizi 1\*Rj45 (Konnektörsüz)



**2220 136 01XX**  
Data Prizi 1\*Rj45 (Cat5e)

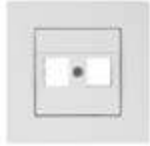

**2220 137 01XX**  
Data Prizi 2\*Rj45 (Konnektörsüz)



**2220 138 01XX**  
Data Prizi 2\*Rj45 (Cat5e)



**2220 139 01XX**  
Telefon Data Prizi (Rj11 Cat3 + Cat5e)



**2220 140 01XX**  
Data Prizi 1\*Rj45 (Cat6)



**2220 141 01XX**  
Data Prizi 2\*Rj45 (Cat6)



**2220 142 01XX**  
Telefon Data Prizi Rj45 (Cat6)



**2220 455 01XX**  
1\*USB Prizi



**2220 456 01XX**  
2\*USB Prizi



**2220 457 01XX**  
1\*HDMI Prizi



**2220 458 01XX**  
2\*HDMI Priz



**2220 459 01XX**  
1\*USB/1 HDMI Priz



**2220 460 01XX**  
VGA Priz



**2220 147 01XX**  
Tek Çıkışlı Fiber Optik Priz



**2220 461 01XX**  
İki Çıkışlı Fiber Optik Priz



**2220 121 02XX**  
Kör Kapak

## TV-SAT GRUBU



**2220 156 02XX**  
Tv-Sat Prizi (Geçişli) 4DB/F Konnektörlü



**2220 157 02XX**  
Tv-Sat Prizi (Sonlu)



**2220 166 01XX**  
Sat Prizi (Geçişli) 4DB/F Konnektörlü



**2220 167 01XX**  
Sat Prizi (Sonlu)



**2220 440 02XX**  
RL Işıklı Dimmer 600W



**2220 444 02XX**  
RL Işıklı Dimmer 1000W



**2220 447 02XX**  
RC Dimmer 325W



**2220 170 01XX**  
Tv Prizi (Geçişli) 11DB



**2220 171 01XX**  
Tv Prizi (Sonlu)



**2220 172 01XX**  
Tv Prizi F Dişi



**2220 122 02XX**  
Kablo Çıkışı

YENİ

## DİMMER GRUBU



**NATURAL**



01 - BEYAZ

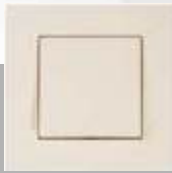

02 - KREM

**AHŞAP**



56 - KIRAZ



57 - CEVİZ



58 - MEŞE

**METALİK**



80 - A.ALTIN



82 - İNOX



83 - TİTANYUM



84 - SİYAH



85 - DORE



86 - ANTRASİT



95 - FÜME

| Kod                               | Ürün Tanımı                                    | Kutu Adedi | Koli Adedi | Beyaz/Krem Fiyat (₺) | Metalik Fiyat (₺) | Ahşap Fiyat (₺) |
|-----------------------------------|--|------------|------------|----------------------|-------------------|-----------------|
| <b>Anahtar Grubu - Vidalı Tip</b> |  |            |            |                      |                   |                 |
| 2200 401 02XX                     | Mek+Tuş Anahtar (Vidalı)                       | 12         | 120        | 163,64               | 227,27            | 250,00          |
| 2200 402 02XX                     | Mek+Tuş Komütatör (Vidalı)                     | 12         | 120        | 207,95               | 277,27            | 305,00          |
| 2200 403 02XX                     | Mek+Tuş Vavien (İki Yollu Anahtar)(Vidalı)     | 12         | 120        | 200,00               | 268,18            | 295,00          |
| 2200 404 02XX                     | Mek+Tuş Komütatör Vavien (Vidalı)              | 12         | 120        | 348,18               | 454,55            | 500,00          |
| 2200 405 02XX                     | Mek+Tuş Çift Kutuplu Anahtar (Vidalı)          | 12         | 120        | 231,82               | 295,45            | 325,00          |
| 2200 406 02XX                     | Mek+Tuş Jaluzi Anahtar (Vidalı)                | 12         | 120        | 350,00               | 400,00            | 440,00          |
| 2200 407 02XX                     | Mek+Tuş Çağırma (Vidalı)                       | 12         | 120        | 177,27               | 236,36            | 260,00          |
| 2200 407 02XXX                    | Mek+Tuş Kapı Otomatığı Anahtar (Vidalı)        | 12         | 120        | 177,27               | 236,36            | 260,00          |
| 2200 407 02XXZ                    | Mek+Tuş Zil Anahtar (Vidalı)                   | 12         | 120        | 177,27               | 236,36            | 260,00          |
| 2200 408 02XX                     | Mek+Tuş Deviatör(Ara Vavien)(Vidalı)           | 12         | 120        | 385,00               | 409,09            | 450,00          |
| 2200 409 02XX                     | Mek+Tuş Üçlü Anahtar (Vidalı)                  | 12         | 120        | 340,00               | 431,82            | 475,00          |
| <b>YENİ</b> 2200 410 02XX         | Mek+Tuş DND Komütatör Anahtar (Vidalı)         | 12         | 120        | 363,64               | 409,09            | 449,90          |
| 2200 411 02XX                     | Mek+Tuş Şofben Anahtar (Vidalı)                | 12         | 120        | 277,27               | 361,74            | 397,92          |
| 2200 415 02XX                     | Mek+Tuş Işıklı Anahtar (220V) (Vidalı)         | 12         | 120        | 275,00               | 363,64            | 400,00          |
| 2200 416 02XX                     | Mek+Tuş Işıklı Vavien (220V) (Vidalı)          | 12         | 120        | 340,00               | 418,18            | 460,00          |
| 2200 417 02XX                     | Mek+Tuş Işıklı Çağırma (220V)(Vidalı)          | 12         | 120        | 275,00               | 390,91            | 430,00          |
| 2200 418 02XX                     | Mek+Tuş Işıklı Etik. Anahtar (220V)(Vidalı)    | 12         | 120        | 306,00               | 340,91            | 375,00          |
| 2200 419 02XX                     | Mek+Tuş Işıklı Etik. Çağırma (220V)(Vidalı)    | 12         | 120        | 304,00               | 409,09            | 450,00          |
| 2200 422 02XX                     | Mek+Tuş Işıklı Zil Etik. Çağırma (12V)(Vidalı) | 12         | 120        | 381,82               | 454,55            | 500,00          |
| 2200 425 02XX                     | Mek+Tuş Tek Tuşlu Jaluzi Anahtar (Vidalı)      | 12         | 120        | 340,91               | 404,57            | 445,02          |
| 2200 426 02XX                     | Mek+Tuş Işıklı Komütatör (Vidalı)              | 12         | 120        | 363,64               | 386,36            | 425,00          |
| 2200 436 02XX                     | Mek+Tuş Jaluzi Anahtar (Yaysız)(Vidalı)        | 12         | 120        | 340,00               | 404,55            | 445,00          |



\* Çoklu çerçeve ile kullanılamaz.

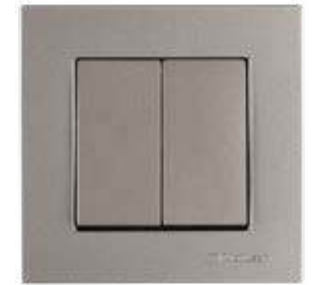

ANAHTAR PRİZ GRUBU

**Anahtar Grubu Klipsli Tip (Kolay Bağlantı)**

|                           |   |    |     |        |        |        |
|---------------------------|---|----|-----|--------|--------|--------|
| 2200 401 01XX             | Mek+Tuş Anahtar (Klipsli)                       | 12 | 120 | 163,64 | 227,27 | 250,00 |
| 2200 402 01XX             | Mek+Tuş Komütatör (Klipsli)                     | 12 | 120 | 207,95 | 277,27 | 305,00 |
| 2200 403 01XX             | Mek+Tuş Vavien (İki Yollu Anahtar)(Klipsli)     | 12 | 120 | 200,00 | 268,18 | 295,00 |
| 2200 404 01XX             | Mek+Tuş Komütatör Vavien (Klipsli)              | 12 | 120 | 348,18 | 454,55 | 500,00 |
| 2200 405 01XX             | Mek+Tuş Çift Kutuplu Anahtar (Klipsli)          | 12 | 120 | 231,82 | 295,45 | 325,00 |
| 2200 406 01XX             | Mek+Tuş Jaluzi Anahtar (Klipsli)                | 12 | 120 | 350,00 | 400,00 | 440,00 |
| 2200 407 01XX             | Mek+Tuş Çağırma (Klipsli)                       | 12 | 120 | 177,27 | 236,36 | 260,00 |
| 2200 407 01XXX            | Mek+Tuş Kapı Otomatığı Anahtar (Klipsli)        | 12 | 120 | 177,27 | 236,36 | 260,00 |
| 2200 407 01XXZ            | Mek+Tuş Zil Anahtar (Klipsli)                   | 12 | 120 | 177,27 | 236,36 | 260,00 |
| 2200 408 01XX             | Mek+Tuş Deviatör(Ara Vavien)(Klipsli)           | 12 | 120 | 385,00 | 409,09 | 450,00 |
| 2200 409 01XX             | Mek+Tuş Üçlü Anahtar (Klipsli)                  | 12 | 120 | 340,00 | 431,82 | 475,00 |
| <b>YENİ</b> 2200 410 01XX | Mek+Tuş DND Komütatör Anahtar (Klipsli)         | 12 | 120 | 363,64 | 409,09 | 449,90 |
| 2200 415 01XX             | Mek+Tuş Işıklı Anahtar (220V) (Klipsli)         | 12 | 120 | 275,00 | 363,64 | 400,00 |
| 2200 416 01XX             | Mek+Tuş Işıklı Vavien (220V) (Klipsli)          | 12 | 120 | 340,00 | 418,18 | 460,00 |
| 2200 417 01XX             | Mek+Tuş Işıklı Çağırma (220V)(Klipsli)          | 12 | 120 | 275,00 | 390,91 | 430,00 |
| 2200 418 01XX             | Mek+Tuş Işıklı Etik. Anahtar (220V)(Klipsli)    | 12 | 120 | 306,00 | 340,91 | 375,00 |
| 2200 419 01XX             | Mek+Tuş Işıklı Etik. Çağırma (220V)(Klipsli)    | 12 | 120 | 304,00 | 409,09 | 450,00 |
| 2200 422 01XX             | Mek+Tuş Işıklı Zil Etik. Çağırma (12V)(Klipsli) | 12 | 120 | 381,82 | 454,55 | 500,00 |
| 2200 426 01XX             | Mek+Tuş Işıklı Komütatör (Klipsli)              | 12 | 120 | 363,64 | 386,36 | 425,00 |
| 2200 436 01XX             | Mek+Tuş Jaluzi Anahtar (Yaysız)(Klipsli)        | 12 | 120 | 340,00 | 404,55 | 445,00 |

**Dimmer Grubu**

|               |                                |   |    |          |          |          |
|---------------|--------------------------------|---|----|----------|----------|----------|
| 2200 440 02XX | Mek+Tuş RL Işıklı Dimmer 600W  | 8 | 80 | 909,09   | 1.000,00 | 1.100,00 |
| 2200 444 02XX | Mek+Tuş RL Işıklı Dimmer 1000W | 8 | 80 | 1.000,00 | 1.090,91 | 1.200,00 |
| 2200 447 02XX | Mek+Tuş RC Dimmer 325W         | 8 | 80 | 1.818,18 | 2.500,00 | 2.750,00 |

| Kod                   | Ürün Tanımı                                 | Kutu Adedi | Koli Adedi | Beyaz/Krem Fiyat (₺) | Metalik Fiyat (₺) | Ahşap Fiyat (₺) |
|-----------------------|---|------------|------------|----------------------|-------------------|-----------------|
| <b>İletişim Grubu</b> |   |            |            |                      |                   |                 |
| 2200 125 01XX         | Mek+Tuş Telefon Prizi 1XRj11 (Cat3)         | 12         | 120        | 190,91               | 304,55            | 335,00          |
| 2200 126 01XX         | Mek+Tuş Telefon Prizi 2XRj11 (Cat3)         | 12         | 120        | 318,18               | 440,91            | 485,00          |
| 2200 128 01XX         | Mek+Tuş Etiketli Tlf Data Priz (Kon.süz)    | 12         | 120        | 136,36               | 197,73            | 217,50          |
| 2200 135 01XX         | Mek+Tuş Data Prizi 1*Rj45 (Kon.süz)         | 12         | 120        | 136,36               | 177,95            | 195,75          |
| 2200 136 01XX         | Mek+Tuş Data Prizi 1*Rj45 (Cat5e)           | 12         | 120        | 500,00               | 590,91            | 650,00          |
| 2200 137 01XX         | Mek+Tuş Data Prizi 2*Rj45 (Kon.süz)         | 12         | 120        | 145,45               | 184,55            | 203,00          |
| 2200 138 01XX         | Mek+Tuş Data Prizi 2*Rj45 (Cat5e)           | 12         | 120        | 727,27               | 818,18            | 900,00          |
| 2200 139 01XX         | Mek+Tuş Tlf Data Priz (Rj11 Cat3 + Cat5e)   | 12         | 120        | 590,91               | 750,00            | 825,00          |
| 2200 140 01XX         | Mek+Tuş Data Prizi 1*Rj45 (Cat6)            | 12         | 120        | 500,00               | 590,91            | 650,00          |
| 2200 141 01XX         | Mek+Tuş Data Prizi 2*Rj45 (Cat6)            | 12         | 120        | 727,27               | 818,18            | 900,00          |
| 2200 142 01XX         | Mek+Tuş Tlf Data Priz (Rj45 Cat6)           | 12         | 120        | 590,91               | 750,00            | 825,00          |
| 2200 455 01XX         | Mek+Tuş 1*USB Priz                          | 12         | 120        | 423,79               | 527,27            | 580,00          |
| 2200 456 01XX         | Mek+Tuş 2*USB Priz                          | 12         | 120        | 723,12               | 922,73            | 1.015,00        |
| 2200 457 01XX         | Mek+Tuş 1*HDMI Priz                         | 12         | 120        | 563,06               | 725,00            | 797,50          |
| 2200 458 01XX         | Mek+Tuş 2*HDMI Priz                         | 12         | 120        | 1.016,90             | 1.285,23          | 1.413,75        |
| 2200 459 01XX         | Mek+Tuş 1*USB/1*HDMI Priz                   | 12         | 120        | 1.152,03             | 1.515,91          | 1.667,50        |
| 2200 460 01XX         | Mek+Tuş VGA Priz                            | 12         | 120        | 1.208,93             | 1.515,91          | 1.667,50        |
| 2200 147 01XX         | Mek+Tuş Bir Çıkışlı Fiber Optik Priz (Rj45) | 12         | 120        | 280,57               | 409,09            | 450,00          |
| 2200 461 01XX         | Mek+Tuş İki Çıkışlı Fiber Optik Priz        | 12         | 120        | 423,83               | 593,18            | 652,50          |
| 2200 121 02XX         | Mek+Tuş Kör Kapak                           | 12         | 120        | 92,65                | 159,09            | 175,00          |

### Priz Grubu

|               |  |    |     |        |          |          |
|---------------|--|----|-----|--------|----------|----------|
| 2200 600 02XX | Mek+Tuş Topraklı Priz                              | 12 | 120 | 190,91 | 272,73   | 300,00   |
| 2200 601 02XX | Mek+Tuş Topraksız Priz                             | 12 | 120 | 172,73 | 245,45   | 270,00   |
| 2200 605 02XX | Mek+Tuş Topraklı Priz (Ç.K.)                       | 12 | 120 | 245,45 | 363,64   | 400,00   |
| 2200 606 02XX | Mek+Tuş Topraksız Priz (Ç.K.)                      | 12 | 120 | 218,18 | 286,36   | 315,00   |
| 2200 610 02XX | Mek+Tuş Kapaklı Topraklı Priz                      | 12 | 120 | 226,26 | 300,00   | 330,00   |
| 2200 611 02XX | Mek+Tuş Kapaklı Topraklı Priz (Ç.K.)               | 12 | 120 | 250,00 | 431,82   | 475,00   |
| 2200 615 02XX | Mek+Tuş Ups (Fransız) Prizi                        | 12 | 120 | 248,33 | 359,09   | 395,00   |
| 2200 616 02XX | Mek+Tuş Ups (Fransız) Prizi (Ç.K.)                 | 12 | 120 | 269,64 | 409,09   | 450,00   |
| 2200 617 02XX | Mek+Tuş Ups Kapaklı (Fransız) Priz                 | 12 | 120 | 264,21 | 363,64   | 400,00   |
| 2200 618 02XX | Mek+Tuş Ups Kapaklı (Fr.) Priz (Ç.K.)              | 12 | 120 | 287,58 | 431,82   | 475,00   |
| 2200 200 02XX | Mek+Tuş İkilili Topraklı Priz Porselen             | 5  | 50  | 431,82 | 545,45   | 600,00   |
| 2200 201 02XX | Mek+Tuş İkilili Topraksız Priz Porselen            | 5  | 50  | 363,64 | 409,09   | 450,00   |
| 2200 202 02XX | Mek+Tuş İkilili Topraklı Priz                      | 5  | 50  | 345,45 | 409,09   | 450,00   |
| 2200 203 02XX | Mek+Tuş İkilili Topraksız Priz                     | 5  | 50  | 295,45 | 340,91   | 375,00   |
| 2200 215 02XX | Mek+Tuş İkilili Ups Priz                           | 5  | 50  | 340,91 | 431,82   | 475,00   |
| 2200 448 01XX | Mek+Tuş Tekli Usb Şarj Prizi                       | 5  | 50  | 590,52 | 750,00   | 825,00   |
| 2200 469 01XX | Mek+Tuş İkilili Usb + Type-C Şarj Prizi            | 5  | 50  | 750,00 | 863,64   | 950,00   |
| 2220 629 02XX | Ritü Usb + Tip-C İli Topraklı Priz (Çerçeve Dahil) | 8  | -   | 909,09 | 1.363,64 | 1.500,00 |



| Kod                       | Ürün Tanımı                               | Kutu Adedi | Koli Adedi | Beyaz/Krem Fiyat (₺) | Metalik Fiyat (₺) | Ahşap Fiyat (₺) |
|---------------------------|---|------------|------------|----------------------|-------------------|-----------------|
| <b>TV / SAT Grubu</b>     |   |            |            |                      |                   |                 |
| 2200 156 02XX             | Mek+Tuş Tv-Sat Prizi (Geçişli) 4DB/F Kon. | 12         | 120        | 863,64               | 1.090,91          | 1.200,00        |
| 2200 157 02XX             | Mek+Tuş Tv-Sat Prizi (Sonlu)              | 12         | 120        | 863,64               | 1.090,91          | 1.200,00        |
| 2200 166 01XX             | Mek+Tuş Sat Prizi (Geçişli) 4DB/F Kon.    | 12         | 120        | 795,45               | 909,09            | 1.000,00        |
| 2200 167 01XX             | Mek+Tuş Sat Prizi (Sonlu)                 | 12         | 120        | 795,45               | 909,09            | 1.000,00        |
| 2200 170 01XX             | Mek+Tuş Tv Prizi (Geçişli) 11DB           | 12         | 120        | 272,73               | 318,18            | 350,00          |
| 2200 171 01XX             | Mek+Tuş Tv Prizi (Sonlu)                  | 12         | 120        | 272,73               | 318,18            | 350,00          |
| 2200 172 01XX             | Mek+Tuş Tv Prizi F Dişi                   | 12         | 120        | 204,55               | 272,73            | 300,00          |
| <b>YENİ</b> 2200 122 01XX | Mek+Tuş Kablo Çıkışı                      | 12         | 120        | 116,57               | 147,35            | 162,09          |

**Elektronik Grubu**

|               |  |    |     |                                       |          |          |
|---------------|--|----|-----|---------------------------------------|----------|----------|
| 2200 450 01XX | Mek+Tuş Energy Saver Gecikmesiz Işıklı | 8  | 80  | 1.000,00                              | 1.212,25 | 1.333,48 |
| 2200 452 01XX | Mek+Tuş Energy Saver Gecikmeli Işıklı  | 8  | 80  | 1.000,00                              | 1.276,05 | 1.403,66 |
| 2200 454 01XX | Mek+Tuş Temassız                       | 12 | 120 | 2.355,77                              | 2.500,00 | 2.750,00 |
| 2200 470 02XX | Mek+Tuş Müzik Yayın Anahtarı           | 8  | 80  | 1.422,09                              | 1.515,01 | 1.666,51 |
| 2200 480 01XX | Mek+Tuş Hoparlör Prizi                 | 8  | 80  | 278,57                                | 403,91   | 444,30   |
| 2200 485 02XX | Mek+Tuş Uyanı Zili                     | 8  | 80  | 2.135,09                              | 2.329,15 | 2.562,06 |
| 2200 495 02XX | Mek+Tuş Hareket Sensörü                | 8  | 80  | 2.045,45                              | 2.144,75 | 2.359,22 |
| 2200 250 01XX | Mek+Tuş Speakhone Prizi                | 12 | 120 | MÜŞTERİ<br>TEMSİLCİSİNE FİYAT SORUNUZ |          |          |
| 2200 251 01XX | Mek+Tuş RCA Prizi                      | 12 | 120 |                                       |          |          |
| 2200 252 01XX | Mek+Tuş 3,5 Ses Jakı                   | 12 | 120 |                                       |          |          |
| 2200 253 01XX | Mek+Tuş XLR Erkek Prizi                | 12 | 120 |                                       |          |          |
| 2200 254 01XX | Mek+Tuş XLR Dişi Prizi                 | 12 | 120 |                                       |          |          |
| 2200 255 01XX | Mek+Tuş Usb Printer Prizi              | 12 | 120 |                                       |          |          |

**Çerçeveler**

|               |                                    |    |     |        |        |        |
|---------------|------------------------------------|----|-----|--------|--------|--------|
| 2220 800 11XX | Tekli Çerçeve                      | 20 | 400 | 21,59  | 86,36  | 95,00  |
| 2220 800 12XX | İkili Yatay Çerçeve                | 10 | 200 | 122,73 | 181,82 | 200,00 |
| 2220 800 13XX | Üçlü Yatay Çerçeve                 | 10 | 50  | 159,09 | 250,00 | 275,00 |
| 2220 800 14XX | Dörtlü Yatay Çerçeve               | 10 | 50  | 195,45 | 318,18 | 350,00 |
| 2220 800 15XX | Beşli Yatay Çerçeve                | 10 | 50  | 245,45 | 386,36 | 425,00 |
| 2220 800 16XX | Altılı Yatay Çerçeve               | 10 | 50  | 295,45 | 454,55 | 500,00 |
| 2220 800 22XX | İkili Dikey Çerçeve                | 10 | 50  | 122,73 | 181,82 | 200,00 |
| 2220 800 23XX | Üçlü Dikey Çerçeve                 | 10 | 50  | 159,09 | 250,00 | 275,00 |
| 2220 800 24XX | Dörtlü Dikey Çerçeve               | 10 | 50  | 195,45 | 318,18 | 350,00 |
| 2220 800 25XX | Beşli Dikey Çerçeve                | 10 | 50  | 245,45 | 386,36 | 425,00 |
| 2220 800 26XX | Altılı Dikey Çerçeve               | 10 | 50  | 295,45 | 454,55 | 500,00 |
| 2220 820 12XX | İkili Priz Çerçeve                 | 12 | 60  | 86,36  | 136,36 | 150,00 |
| 2200 000 11XX | Sıva Üstü Anahtar Kasası (Geçmeli) | -  | -   | 125,00 | 172,73 | 190,00 |
| 2200 800 00XX | Telefon Tutucu                     | 24 | 240 | 45,45  | -      | -      |
| 2200 000 0001 | IP44 Kapaklı Priz Conta            | 24 | 120 | 45,45  | -      | -      |



# Elitra | Plus

## Elitra Glass BEYAZ / SİYAH ÇERÇEVELER - CAM

| Kod           | Ürün Tanımı          | Kutu Adedi | Fiyat (₺) |
|---------------|----------------------|------------|-----------|
| 2170 XXX 11XX | Tekli Çerçeve        | 10         | 643,53    |
| 2170 XXX 12XX | Yatay İkili Çerçeve  | 10         | 1.507,71  |
| 2170 XXX 13XX | Yatay Üçlü Çerçeve   | 10         | 2.539,02  |
| 2170 XXX 14XX | Yatay Dörtlü Çerçeve | 10         | 2.864,48  |
| 2170 XXX 15XX | Yatay Beşli Çerçeve  | 10         | 4.303,67  |
| 2170 XXX 22XX | Dikey İkili Çerçeve  | 10         | 1.507,71  |
| 2170 XXX 23XX | Dikey Üçlü Çerçeve   | 10         | 2.539,02  |
| 2170 XXX 24XX | Dikey Dörtlü Çerçeve | 10         | 2.864,48  |
| 2170 XXX 25XX | Dikey Beşli Çerçeve  | 10         | 4.303,67  |

XXX-811



XXX-814

Beyaz  
 Gümüş  
 XX-01    XX-92

## Elitra Chrome KROM / PASLANMAZ ÇELİK / ALTIN ÇERÇEVELER

| Kod           | Ürün Tanımı          | Kutu Adedi | Fiyat (₺) |
|---------------|----------------------|------------|-----------|
| 2170 XXX 1190 | Tekli Çerçeve        | 10         | 1.259,57  |
| 2170 XXX 1290 | Yatay İkili Çerçeve  | 10         | 1.993,87  |
| 2170 XXX 1390 | Yatay Üçlü Çerçeve   | 10         | 2.640,12  |
| 2170 XXX 1490 | Yatay Dörtlü Çerçeve | 10         | 2.967,25  |
| 2170 XXX 1590 | Yatay Beşli Çerçeve  | 10         | 3.677,90  |
| 2170 XXX 1690 | Yatay Altılı Çerçeve | 10         | 4.869,43  |
| 2170 XXX 2290 | Dikey İkili Çerçeve  | 10         | 1.993,87  |
| 2170 XXX 2390 | Dikey Üçlü Çerçeve   | 10         | 2.640,12  |
| 2170 XXX 2490 | Dikey Dörtlü Çerçeve | 10         | 2.967,25  |
| 2170 XXX 2590 | Dikey Beşli Çerçeve  | 10         | 3.677,90  |
| 2170 XXX 2690 | Dikey Altılı Çerçeve | 10         | 4.869,43  |

XXX-821



XXX-822

XXX-824

## Elitra Chrome GÜMÜŞ - PARLAK FÜME ÇERÇEVELER

| Kod           | Ürün Tanımı          | Kutu Adedi | Fiyat (₺) |
|---------------|----------------------|------------|-----------|
| 2170 825 1192 | Tekli Çerçeve        | 10         | 1.053,67  |
| 2170 825 1292 | Yatay İkili Çerçeve  | 10         | 1.843,10  |
| 2170 825 1392 | Yatay Üçlü Çerçeve   | 10         | 2.618,06  |
| 2170 825 1492 | Yatay Dörtlü Çerçeve | 10         | 3.238,71  |
| 2170 825 1592 | Yatay Beşli Çerçeve  | 10         | 3.686,09  |
| 2170 825 1692 | Yatay Altılı Çerçeve | 10         | 4.281,20  |
| 2170 825 2292 | Dikey İkili Çerçeve  | 10         | 1.843,10  |
| 2170 825 2392 | Dikey Üçlü Çerçeve   | 10         | 2.618,06  |
| 2170 825 2492 | Dikey Dörtlü Çerçeve | 10         | 3.238,71  |
| 2170 825 2592 | Dikey Beşli Çerçeve  | 10         | 3.686,09  |
| 2170 825 2692 | Dikey Altılı Çerçeve | 10         | 4.281,20  |

XXX-825



XXX-825

XXX-827



XXX-828



XXX-832

XXX-833

Gümüş  
XX-92 Saten  
XX-90

XXX-834

## Elitra Chrome

## MAT ALÜMİNYUM - MAT SATEN ÇERÇEVELER

| Kod           | Ürün Tanımı          | Kutu Adedi | Fiyat (₺) |
|---------------|----------------------|------------|-----------|
| 2170 XXX 1195 | Tekli Çerçeve        | 10         | 990,94    |
| 2170 XXX 1295 | Yatay İkili Çerçeve  | 10         | 1.551,87  |
| 2170 XXX 1395 | Yatay Üçlü Çerçeve   | 10         | 2.055,57  |
| 2170 XXX 1495 | Yatay Dörtlü Çerçeve | 10         | 2.528,08  |
| 2170 XXX 1595 | Yatay Beşli Çerçeve  | 10         | 3.196,01  |
| 2170 XXX 1695 | Yatay Altılı Çerçeve | 10         | 4.263,90  |
| 2170 XXX 2295 | Dikey İkili Çerçeve  | 10         | 1.551,87  |
| 2170 XXX 2395 | Dikey Üçlü Çerçeve   | 10         | 2.055,57  |
| 2170 XXX 2495 | Dikey Dörtlü Çerçeve | 10         | 2.528,08  |
| 2170 XXX 2595 | Dikey Beşli Çerçeve  | 10         | 3.196,01  |
| 2170 XXX 2695 | Dikey Altılı Çerçeve | 10         | 4.263,90  |

## Elitra Wood

## KAYIN / KIRAZ / VENGE ÇERÇEVELER

| Kod           | Ürün Tanımı          | Kutu Adedi | Fiyat (₺) |
|---------------|----------------------|------------|-----------|
| 2170 XXX 11XX | Tekli Çerçeve        | 10         | 958,99    |
| 2170 XXX 12XX | Yatay İkili Çerçeve  | 10         | 1.543,76  |
| 2170 XXX 13XX | Yatay Üçlü Çerçeve   | 10         | 2.228,84  |
| 2170 XXX 14XX | Yatay Dörtlü Çerçeve | 10         | 2.807,88  |
| 2170 XXX 15XX | Yatay Beşli Çerçeve  | 10         | 3.472,53  |
| 2170 XXX 22XX | Dikey İkili Çerçeve  | 10         | 1.543,76  |
| 2170 XXX 23XX | Dikey Üçlü Çerçeve   | 10         | 2.228,84  |
| 2170 XXX 24XX | Dikey Dörtlü Çerçeve | 10         | 2.807,88  |
| 2170 XXX 25XX | Dikey Beşli Çerçeve  | 10         | 3.472,53  |

## Elitra Marble

## BLACK QUARTZ / SAND STONE ÇERÇEVELER

| Kod           | Ürün Tanımı          | Kutu Adedi | Fiyat (₺) |
|---------------|----------------------|------------|-----------|
| 2170 XXX 11XX | Tekli Çerçeve        | 10         | 1.163,81  |
| 2170 XXX 12XX | Yatay İkili Çerçeve  | 10         | 1.342,78  |
| 2170 XXX 13XX | Yatay Üçlü Çerçeve   | 10         | 2.047,29  |
| 2170 XXX 14XX | Yatay Dörtlü Çerçeve | 10         | 2.665,82  |
| 2170 XXX 15XX | Yatay Beşli Çerçeve  | 10         | 3.296,29  |
| 2170 XXX 22XX | Dikey İkili Çerçeve  | 10         | 1.342,78  |
| 2170 XXX 23XX | Dikey Üçlü Çerçeve   | 10         | 2.047,29  |
| 2170 XXX 24XX | Dikey Dörtlü Çerçeve | 10         | 2.665,82  |
| 2170 XXX 25XX | Dikey Beşli Çerçeve  | 10         | 3.296,29  |



XXX-842

Gümüş  
XX-92

XXX-843

## Elitra Ale

## NATURAL / SATEN / MAT FÜME ÇERÇEVELER

| Kod           | Ürün Tanımı          | Kutu Adedi | Fiyat (₺) |
|---------------|----------------------|------------|-----------|
| 2170 XXX 11XX | Tekli Çerçeve        | 10         | 772,57    |
| 2170 XXX 12XX | Yatay İkili Çerçeve  | 10         | 1.325,59  |
| 2170 XXX 13XX | Yatay Üçlü Çerçeve   | 10         | 2.179,01  |
| 2170 XXX 14XX | Yatay Dörtlü Çerçeve | 10         | 2.728,54  |
| 2170 XXX 15XX | Yatay Beşli Çerçeve  | 10         | 3.372,13  |
| 2170 XXX 16XX | Yatay Altılı Çerçeve | 10         | 6.281,23  |
| 2170 XXX 22XX | Dikey İkili Çerçeve  | 10         | 1.325,59  |
| 2170 XXX 23XX | Dikey Üçlü Çerçeve   | 10         | 2.179,01  |
| 2170 XXX 24XX | Dikey Dörtlü Çerçeve | 10         | 2.728,54  |
| 2170 XXX 25XX | Dikey Beşli Çerçeve  | 10         | 3.372,13  |
| 2170 XXX 26XX | Dikey Altılı Çerçeve | 10         | 6.281,23  |



XXX-851

XXX-852

Gümüş  
XX-92 Saten  
XX-90 FÜME  
XX-95

XXX-853

## Elitra | Plus

### Mekanizma + Tuş Ürün Listesi

BEYAZ-01 / SATEN-90 / GÜMÜŞ-92 / FÜME-95

| Kod                               | Ürün Tanımı                               | Kutu Adedi | Fiyat (₺) |
|-----------------------------------|---|------------|-----------|
| <b>Anahtar Grubu - Vidalı Tip</b> |   |            |           |
| 2270 401 02XX                     | Mek+Tuş Anahtar                           | 12         | 227,27    |
| 2270 402 02XX                     | Mek+Tuş Komütatör                         | 12         | 277,27    |
| 2270 403 02XX                     | Mek+Tuş Vavien (İki Yollu Anahtar)        | 12         | 268,18    |
| 2270 404 02XX                     | Mek+Tuş Komütatör Vavien                  | 12         | 454,55    |
| 2270 405 02XX                     | Mek+Tuş Çift Kutuplu Anahtar              | 12         | 295,45    |
| 2270 406 02XX                     | Mek+Tuş Jaluzi Anahtar-Yaylı              | 12         | 400,00    |
| 2270 407 02XX                     | Mek+Tuş Light (Çağırma)                   | 12         | 236,36    |
| 2270 407 02XXZ                    | Mek+Tuş Zil Anahtarı                      | 12         | 236,36    |
| 2270 407 02XXK                    | Mek+Tuş Kapı Otomatığı Anahtarı           | 12         | 236,36    |
| 2270 408 02XX                     | Mek+Tuş Deviatör (Ara Vavien)             | 12         | 409,09    |
| 2270 409 02XX                     | Mek+Tuş Üçlü Anahtar                      | 12         | 431,82    |
| 2270 411 02XX                     | Mek+Tuş Şofben Anahtarı                   | 12         | 361,74    |
| 2270 415 02XX                     | Mek+Tuş Işıklı Anahtar (220V)             | 12         | 363,64    |
| 2270 416 02XX                     | Mek+Tuş Işıklı Vavien (220V)              | 12         | 418,18    |
| 2270 417 02XX                     | Mek+Tuş Işıklı Çağırma (220V)             | 12         | 390,91    |
| 2270 418 02XX                     | Mek+Tuş Işıklı Etiketli Anahtar (220V)    | 12         | 340,91    |
| 2270 419 02XX                     | Mek+Tuş Işıklı Etiketli Çağırma (220V)    | 12         | 409,09    |
| 2270 422 02XX                     | Mek+Tuş Işıklı Zil Etiketli Çağırma (12V) | 12         | 454,55    |
| 2270 426 02XX                     | Mek+Tuş Işıklı Komütatör                  | 12         | 386,36    |



### Anahtar Grubu - Klipsli Tip (Kolay Bağlantı)

|                |   |    |        |
|----------------|---|----|--------|
| 2270 401 01XX  | Mek+Tuş Anahtar                           | 12 | 227,27 |
| 2270 402 01XX  | Mek+Tuş Komütatör                         | 12 | 277,27 |
| 2270 403 01XX  | Mek+Tuş Vavien (İki Yollu Anahtar)        | 12 | 268,18 |
| 2270 404 01XX  | Mek+Tuş Komütatör Vavien                  | 12 | 454,55 |
| 2270 405 01XX  | Mek+Tuş Çift Kutuplu Anahtar              | 12 | 295,45 |
| 2270 406 01XX  | Mek+Tuş Jaluzi Anahtar-Yaylı              | 12 | 400,00 |
| 2270 407 01XX  | Mek+Tuş Light (Çağırma)                   | 12 | 236,36 |
| 2270 407 01XXZ | Mek+Tuş Zil Anahtarı                      | 12 | 236,36 |
| 2270 407 01XXK | Mek+Tuş Kapı Otomatığı Anahtarı           | 12 | 236,36 |
| 2270 408 01XX  | Mek+Tuş Deviatör (Ara Vavien)             | 12 | 409,09 |
| 2270 409 01XX  | Mek+Tuş Üçlü Anahtar                      | 12 | 431,82 |
| 2270 415 01XX  | Mek+Tuş Işıklı Anahtar (220V)             | 12 | 363,64 |
| 2270 416 01XX  | Mek+Tuş Işıklı Vavien (220V)              | 12 | 418,18 |
| 2270 417 01XX  | Mek+Tuş Işıklı Çağırma (220V)             | 12 | 390,91 |
| 2270 418 01XX  | Mek+Tuş Işıklı Etiketli Anahtar (220V)    | 12 | 340,91 |
| 2270 419 01XX  | Mek+Tuş Işıklı Etiketli Çağırma (220V)    | 12 | 409,09 |
| 2270 422 01XX  | Mek+Tuş Işıklı Zil Etiketli Çağırma (12V) | 12 | 454,55 |
| 2270 426 01XX  | Mek+Tuş Işıklı Komütatör                  | 12 | 386,36 |



### Dimmer Grubu

|               |                             |   |          |
|---------------|-----------------------------|---|----------|
| 2270 440 02XX | Mek+Tuş Işıklı Dimmer 600W  | 8 | 1.000,00 |
| 2270 444 02XX | Mek+Tuş Işıklı Dimmer 1000W | 8 | 1.090,91 |
| 2270 447 02XX | Mek+Tuş RC Dimmer 325W      | 8 | 2.500,00 |

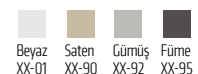

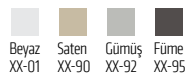

| Kod               | Ürün Tanımı                            | Kutu Adedi | Fiyat (₺) |
|-------------------|--|------------|-----------|
| <b>Priz Grubu</b> |  |            |           |
| 2270 600 02XX     | Mek+Tuş Topraklı Priz                  | 12         | 272,73    |
| 2270 601 02XX     | Mek+Tuş Topraksız Priz                 | 12         | 245,45    |
| 2270 605 02XX     | Mek+Tuş Topraklı Priz (Ç.K.)           | 12         | 363,64    |
| 2270 606 02XX     | Mek+Tuş Topraksız Priz (Ç.K.)          | 12         | 286,36    |
| 2270 610 02XX     | Mek+Tuş Kapaklı Topraklı Priz          | 12         | 300,00    |
| 2270 611 02XX     | Mek+Tuş Kapaklı Topraklı Priz (Ç.K.)   | 12         | 431,82    |
| 2270 615 02XX     | Mek+Tuş Ups (Fransız) Prizi            | 12         | 359,09    |
| 2270 616 02XX     | Mek+Tuş Ups (Fransız) Prizi(Ç.K.)      | 12         | 409,09    |
| 2270 617 02XX     | Mek+Tuş Ups Kapaklı (Fransız) Priz     | 12         | 363,64    |
| 2270 618 02XX     | Mek+Tuş Ups Kap. (Fransız) Priz (Ç.K.) | 12         | 431,82    |
| 2270 121 01XX     | Mek+Tuş Kör Kapak                      | 12         | 159,09    |
| 2270 448 01XX     | Mek+Tuş Tekli Usb Şarj Prizi           | 5          | 750,00    |

### İletişim Grubu

|               |   |    |          |
|---------------|---|----|----------|
| 2270 455 01XX | Mek+Tuş 1*USB Priz                          | 12 | 527,27   |
| 2270 456 01XX | Mek+Tuş 2*USB Priz                          | 12 | 922,73   |
| 2270 457 01XX | Mek+Tuş 1*HDMI Priz                         | 12 | 725,00   |
| 2270 458 01XX | Mek+Tuş 2*HDMI Priz                         | 12 | 1.285,23 |
| 2270 459 01XX | Mek+Tuş 1*USB/1*HDMI Priz                   | 12 | 1.515,91 |
| 2270 125 01XX | Mek+Tuş Telefon Prizi 1*Rj11 Cat3           | 12 | 304,55   |
| 2270 126 01XX | Mek+Tuş Telefon Prizi 2*Rj11 Cat3           | 12 | 440,91   |
| 2270 128 01XX | Mek+Tuş Etiketli Tlf+Data Priz (Kon.süz)    | 12 | 197,73   |
| 2270 135 01XX | Mek+Tuş Data Prizi 1*Rj45 (Kon.süz)         | 12 | 177,95   |
| 2270 136 01XX | Mek+Tuş Data Prizi 1*Rj45 (Cat5e)           | 12 | 590,91   |
| 2270 137 01XX | Mek+Tuş Data Prizi 2*Rj45 (Kon.süz)         | 12 | 184,55   |
| 2270 138 01XX | Mek+Tuş Data Prizi 2*Rj45 (Cat5e)           | 12 | 818,18   |
| 2270 139 01XX | Mek+Tuş Tlf+Data Priz Rj11 (Cat3+Cat5e)     | 12 | 750,00   |
| 2270 140 01XX | Mek+Tuş Data Prizi 1*Rj45 (Cat6)            | 12 | 590,91   |
| 2270 141 01XX | Mek+Tuş Data Prizi 2*Rj45 (Cat6)            | 12 | 818,18   |
| 2270 147 01XX | Mek+Tuş Bir Çıkışlı Fiber Optik Priz (RJ45) | 12 | 409,09   |

### Elektronik Grubu

|               |  |   |          |
|---------------|--|---|----------|
| 2270 450 01XX | Mek+Tuş Energy Saver Gecikmesiz Işıklı | 8 | 1.212,25 |
| 2270 452 01XX | Mek+Tuş Energy Saver Gecikmeli         | 8 | 1.276,05 |
| 2270 470 02XX | Mek+Tuş Müzik Yayın Anahtar            | 8 | 1.515,01 |
| 2270 480 01XX | Mek+Tuş Hoparlör Prizi                 | 8 | 403,91   |
| 2270 485 02XX | Mek+Tuş Uyarı Zili                     | 8 | 2.329,15 |
| 2270 495 02XX | Mek+Tuş Hareket Sensörü                | 8 | 2.144,75 |

### TV / SAT Grubu

|               |   |    |          |
|---------------|---|----|----------|
| 2270 156 02XX | Mek+Tuş Tv-Sat Prizi (Geçişli) 4DB/F Kon.   | 12 | 1.090,91 |
| 2270 157 02XX | Mek+Tuş Tv-Sat Prizi (Sonlu)                | 12 | 1.090,91 |
| 2270 166 01XX | Mek+Tuş Sat Prizi (Geçişli) 4DB/F Konnektör | 12 | 909,09   |
| 2270 167 01XX | Mek+Tuş Sat Prizi (Sonlu)                   | 12 | 909,09   |
| 2270 170 01XX | Mek+Tuş Tv Prizi (Geçişli) 11DB             | 12 | 318,18   |
| 2270 171 01XX | Mek+Tuş Tv Prizi (Sonlu)                    | 12 | 318,18   |
| 2270 172 01XX | Mek+Tuş Tv Prizi F Dişi                     | 12 | 272,73   |

## ANAHTAR GRUBU - VİDALI TİP



**2125 401 02XX**  
Anahtar



**2125 402 02XX**  
Komütatör



**2125 403 02XX**  
Vavien (iki yollu anahtar)



**2125 404 02XX**  
Komütatör Vavien



**2125 405 02XX**  
Çift Kutuplu Anahtar



**2125 406 02XX**  
Jaluzi Anahtarı



**2125 407 02XX**  
Çağırma



**2125 407 02XXK**  
Kapı Otomatığı



**2125 407 02XXZ**  
Zil Anahtarı



**2125 408 02XX**  
Deviatör (Ara Vavien)



**2125 409 02XX**  
Üçlü Anahtar



**2125 411 02XX**  
Şofben Anahtarı



**2125 415 02XX**  
Işıklı Anahtar (220V)



**2125 416 02XX**  
Işıklı Vavien (220V)



**2125 417 02XX**  
Işıklı Çağırma (220V)



**2125 418 02XX**  
Işıklı Etiketli Anahtar (220V)



**2125 419 02XX**  
Işıklı Etiketli Çağırma (220V)



**2125 422 02XX**  
Işıklı Zil Etiketli Çağırma (12V)



**2125 426 02XX**  
Işıklı Komitatör



**2125 436 02XX**  
Tek Tuşlu Jaluzi Anahtarı

## ANAHTAR GRUBU - KLİPSLİ TİP (KOLAY BAĞLANTI)



**2125 401 01XX**  
Anahtar



**2125 402 01XX**  
Komütatör



**2125 403 01XX**  
Vavien (iki yollu anahtar)



**2125 404 01XX**  
Komütatör Vavien



**2125 405 01XX**  
Çift Kutuplu Anahtar



**2125 406 01XX**  
Jaluzi Anahtarı



**2125 407 01XX**  
Çağırma



**2125 407 01XXK**  
Kapı Otomatığı



**2125 407 01XXZ**  
Zil Anahtarı



**2125 408 01XX**  
Deviatör (Ara Vavien)



**2125 409 01XX**  
Üçlü Anahtar



**2125 415 01XX**  
Işıklı Anahtar (220V)



**2125 416 01XX**  
Işıklı Vavien (220V)



**2125 417 01XX**  
Işıklı Çağırma (220V)



**2125 418 01XX**  
Işıklı Etiketli Anahtar (220V)



**2125 419 01XX**  
Işıklı Etiketli Çağırma (220V)



**2125 422 01XX**  
Işıklı Zil Etiketli Çağırma (12V)



**2125 426 01XX**  
Işıklı Komitatör



**2125 436 01XX**  
Tek Tuşlu Jaluzi Anahtarı

## DİMMER GRUBU



**2125 440 02XX**  
RL Işıklı Dimmer 600W



**2125 444 02XX**  
RL Işıklı Dimmer 1000W



**2125 447 02XX**  
RC Dimmer 325W

## ELEKTRONİK GRUBU



**2125 450 01XX**  
Energy Saver Gecikmesiz Işıklı



**2125 452 01XX**  
Energy Saver Gecikmeli Işıklı



**2125 470 02XX**  
Müzik Yayın Anahtarı



**2125 480 01XX**  
Hoparlör Prizi



**2125 485 02XX**  
Uyarı Zili



**2125 495 02XX**  
Hareket Sensörü

## PRİZ GRUBU



**2125 600 02XX**

Topraklı Priz



**2125 601 02XX**

Topraksız Priz



**2125 605 02XX**

Topraklı Priz (Ç.K)



**2125 606 02XX**

Topraksız Priz (Ç.K)



**2125 610 02XX**

Kapaklı Topraklı Priz



**2125 611 02XX**

Kapaklı Topraklı Priz (Ç.K)



**2125 615 02XX**

Ups (Fransız) Prizi



**2125 616 02XX**

Ups (Fransız) Prizi (Ç.K)



**2125 617 02XX**

Ups Kapaklı (Fransız) Prizi



**2125 618 02XX**

Ups Kapaklı (Fransız) Prizi (Ç.K)



**2125 448 01XX**

Tekli USB Şarj Prizi



**2125 469 01XX**

İkili USB Şarj Prizi



**2125 200 02XX**

İkili Topraklı Priz Porselen



**2125 201 02XX**

İkili Topraksız Priz Porselen



**2125 202 02XX**

İkili Topraklı Priz



**2125 203 02XX**

İkili Topraksız Priz



**2125 215 02XX**

İkili UPS Priz

## İLETİŞİM GRUBU



**2125 125 01XX**

Telefon Prizi 1XRj11 (Cat3)



**2125 126 01XX**

Telefon Prizi 2XRj11 (Cat3)



**2125 128 01XX**

Etiketli Telefon Data Prizi (Konnektörsüz)



**2125 135 01XX**

Data Prizi 1\*Rj45 (Konnektörsüz)



**2125 136 01XX**

Data Prizi 1\*Rj45 (Cat5e)



**2125 137 01XX**

Data Prizi 2\*Rj45 (Konnektörsüz)



**2220 138 01XX**

Data Prizi 2\*Rj45 (Cat5e)



**2125 139 01XX**

Telefon Data Prizi (Rj11 Cat3 + Cat5e)



**2125 140 01XX**

Data Prizi 1\*Rj45 (Cat6)



**2125 141 01XX**

Data Prizi 2\*Rj45 (Cat6)



**2125 455 01XX**

1\*USB Priz



**2125 456 01XX**

2\*USB Priz



**2125 457 01XX**

1\*HDMI Priz



**2125 458 01XX**

2\*HDMI Priz



**2125 459 01XX**

1\*USB/1\*HDMI Priz



**2125 460 01XX**

VGA Priz



**2125 121 02XX**

Kör Kapak

## TV-SAT GRUBU



**2125 156 02XX**

Tv-Sat Prizi (Geçişli) 4DB/F Konnektörlü



**2125 157 02XX**

Tv-Sat Prizi (Sonlu)



**2125 166 01XX**

Sat Prizi (Geçişli) 4DB/F Konnektörlü



**2125 167 01XX**

Sat Prizi (Sonlu)



**2125 170 01XX**

Tv Prizi (Geçişli) 110B



**2125 171 01XX**

Tv Prizi (Sonlu)



**2125 172 01XX**

Tv Prizi F Dişi

NATURAL



01 - BEYAZ



02 - KREM

AHŞAP



56 - KIRAZ



57 - CEVİZ



58 - MEŞE

METALİK



80 - A.ALTIN



82 - INOX



83 - TİTANYUM



84 - SİYAH



85 - DORE



95 - FÜME



| Kod            | Ürün Tanımı                                    | Kutu Adedi | Koli Adedi | Beyaz/Krem Fiyat (₺) | Metalik Fiyat (₺) | Ahşap Fiyat (₺) |
|----------------|--|------------|------------|----------------------|-------------------|-----------------|
| 2100 401 02XX  | Mek+Tuş Anahtar (Vidalı)                       | 12         | 120        | 163,64               | 227,27            | 250,00          |
| 2100 402 02XX  | Mek+Tuş Komütatör (Vidalı)                     | 12         | 120        | 207,95               | 277,27            | 305,00          |
| 2100 403 02XX  | Mek+Tuş Vavien (İki Yollu Anahtar)(Vidalı)     | 12         | 120        | 200,00               | 268,18            | 295,00          |
| 2100 404 02XX  | Mek+Tuş Komütatör Vavien (Vidalı)              | 12         | 120        | 348,18               | 454,55            | 500,00          |
| 2100 405 02XX  | Mek+Tuş Çift Kutuplu Anahtar (Vidalı)          | 12         | 120        | 231,82               | 295,45            | 325,00          |
| 2100 406 02XX  | Mek+Tuş Jaluzi Anahtarı (Vidalı)               | 12         | 120        | 350,00               | 400,00            | 440,00          |
| 2100 407 02XX  | Mek+Tuş Çağırma (Vidalı)                       | 12         | 120        | 177,27               | 236,36            | 260,00          |
| 2100 407 02XXK | Mek+Tuş Kapı Otomatığı Anahtarı (Vidalı)       | 12         | 120        | 177,27               | 236,36            | 260,00          |
| 2100 407 02XXZ | Mek+Tuş Zil Anahtarı (Vidalı)                  | 12         | 120        | 177,27               | 236,36            | 260,00          |
| 2100 408 02XX  | Mek+Tuş Deviyatör(Ara Vavien)(Vidalı)          | 12         | 120        | 385,00               | 409,09            | 450,00          |
| 2100 409 02XX  | Mek+Tuş Üçlü Anahtar (Vidalı)                  | 12         | 120        | 340,00               | 431,82            | 475,00          |
| 2100 411 02XX  | Mek+Tuş Şofben Anahtarı (Vidalı)               | 12         | 120        | 277,27               | 361,74            | 397,92          |
| 2100 415 02XX  | Mek+Tuş Işıklı Anahtar (220V) (Vidalı)         | 12         | 120        | 275,00               | 363,64            | 400,00          |
| 2100 416 02XX  | Mek+Tuş Işıklı Vavien (220V) (Vidalı)          | 12         | 120        | 340,00               | 418,18            | 460,00          |
| 2100 417 02XX  | Mek+Tuş Işıklı Çağırma (220V)(Vidalı)          | 12         | 120        | 275,00               | 390,91            | 430,00          |
| 2100 418 02XX  | Mek+Tuş Işıklı Etik. Anahtar (220V)(Vidalı)    | 12         | 120        | 306,00               | 340,91            | 375,00          |
| 2100 419 02XX  | Mek+Tuş Işıklı Etik. Çağırma (220V)(Vidalı)    | 12         | 120        | 304,00               | 409,09            | 450,00          |
| 2100 422 02XX  | Mek+Tuş Işıklı Zil Etik. Çağırma (12V)(Vidalı) | 12         | 120        | 381,82               | 454,55            | 500,00          |
| 2100 426 02XX  | Mek+Tuş Işıklı Komütatör (Vidalı)              | 12         | 120        | 363,64               | 386,36            | 425,00          |
| 2100 436 02XX  | Mek+Tuş Jaluzi Anahtarı (Yaysız)(Vidalı)       | 12         | 120        | 340,00               | 404,55            | 445,00          |

### Anahtar Grubu Klipsli Tip (Kolay Bağlantı)

|                |   |    |     |        |        |        |
|----------------|---|----|-----|--------|--------|--------|
| 2100 401 01XX  | Mek+Tuş Anahtar (Klipsli)                       | 12 | 120 | 163,64 | 227,27 | 250,00 |
| 2100 402 01XX  | Mek+Tuş Komütatör (Klipsli)                     | 12 | 120 | 207,95 | 277,27 | 305,00 |
| 2100 403 01XX  | Mek+Tuş Vavien (İki Yollu Anahtar)(Klipsli)     | 12 | 120 | 200,00 | 268,18 | 295,00 |
| 2100 404 01XX  | Mek+Tuş Komütatör Vavien (Klipsli)              | 12 | 120 | 348,18 | 454,55 | 500,00 |
| 2100 405 01XX  | Mek+Tuş Çift Kutuplu Anahtar (Klipsli)          | 12 | 120 | 231,82 | 295,45 | 325,00 |
| 2100 406 01XX  | Mek+Tuş Jaluzi Anahtarı (Klipsli)               | 12 | 120 | 350,00 | 400,00 | 440,00 |
| 2100 407 01XX  | Mek+Tuş Çağırma (Klipsli)                       | 12 | 120 | 177,27 | 236,36 | 260,00 |
| 2100 407 01XXK | Mek+Tuş Kapı Otomatığı Anahtarı (Klipsli)       | 12 | 120 | 177,27 | 236,36 | 260,00 |
| 2100 407 01XXZ | Mek+Tuş Zil Anahtarı (Klipsli)                  | 12 | 120 | 177,27 | 236,36 | 260,00 |
| 2100 408 01XX  | Mek+Tuş Deviyatör(Ara Vavien)(Klipsli)          | 12 | 120 | 385,00 | 409,09 | 450,00 |
| 2100 409 01XX  | Mek+Tuş Üçlü Anahtar (Klipsli)                  | 12 | 120 | 340,00 | 431,82 | 475,00 |
| 2100 415 01XX  | Mek+Tuş Işıklı Anahtar (220V) (Klipsli)         | 12 | 120 | 275,00 | 363,64 | 400,00 |
| 2100 416 01XX  | Mek+Tuş Işıklı Vavien (220V) (Klipsli)          | 12 | 120 | 340,00 | 418,18 | 460,00 |
| 2100 417 01XX  | Mek+Tuş Işıklı Çağırma (220V)(Klipsli)          | 12 | 120 | 275,00 | 390,91 | 430,00 |
| 2100 418 01XX  | Mek+Tuş Işıklı Etik. Anahtar (220V)(Klipsli)    | 12 | 120 | 306,00 | 340,91 | 375,00 |
| 2100 419 01XX  | Mek+Tuş Işıklı Etik. Çağırma (220V)(Klipsli)    | 12 | 120 | 304,00 | 409,09 | 450,00 |
| 2100 422 01XX  | Mek+Tuş Işıklı Zil Etik. Çağırma (12V)(Klipsli) | 12 | 120 | 381,82 | 454,55 | 500,00 |
| 2100 426 01XX  | Mek+Tuş Işıklı Komütatör (Vidalı)               | 12 | 120 | 363,64 | 386,36 | 425,00 |
| 2100 436 01XX  | Mek+Tuş Jaluzi Anahtarı (Yaysız)(Klipsli)       | 12 | 120 | 340,00 | 404,55 | 445,00 |

### Dimmer Grubu

|               |                                |   |    |          |          |          |
|---------------|--------------------------------|---|----|----------|----------|----------|
| 2100 440 02XX | Mek+Tuş RL Işıklı Dimmer 600W  | 8 | 80 | 909,09   | 1.000,00 | 1.100,00 |
| 2100 444 02XX | Mek+Tuş RL Işıklı Dimmer 1000W | 8 | 80 | 1.000,00 | 1.090,91 | 1.200,00 |
| 2100 447 02XX | Mek+Tuş RC Dimmer 325W         | 8 | 80 | 1.818,18 | 2.500,00 | 2.750,00 |

### Priz Grubu

|               |                                       |    |     |        |        |        |
|---------------|---------------------------------------|----|-----|--------|--------|--------|
| 2100 600 02XX | Mek+Tuş Topraklı Priz                 | 12 | 120 | 190,91 | 272,73 | 300,00 |
| 2100 601 02XX | Mek+Tuş Topraksız Priz                | 12 | 120 | 172,73 | 245,45 | 270,00 |
| 2100 605 02XX | Mek+Tuş Topraklı Priz (Ç.K.)          | 12 | 120 | 245,45 | 363,64 | 400,00 |
| 2100 606 02XX | Mek+Tuş Topraksız Priz (Ç.K.)         | 12 | 120 | 218,18 | 286,36 | 315,00 |
| 2100 610 02XX | Mek+Tuş Kapaklı Topraklı Priz         | 12 | 120 | 226,26 | 300,00 | 330,00 |
| 2100 611 02XX | Mek+Tuş Kapaklı Topraklı Priz (Ç.K.)  | 12 | 120 | 250,00 | 431,82 | 475,00 |
| 2100 615 02XX | Mek+Tuş Ups (Fransız) Prizi           | 12 | 120 | 248,33 | 359,09 | 395,00 |
| 2100 616 02XX | Mek+Tuş Ups (Fransız) Prizi (Ç.K.)    | 12 | 120 | 269,64 | 409,09 | 450,00 |
| 2100 617 02XX | Mek+Tuş Ups Kapaklı (Fransız) Priz    | 12 | 120 | 264,21 | 363,64 | 400,00 |
| 2100 618 02XX | Mek+Tuş Ups Kapaklı (Fr.) Priz (Ç.K.) | 12 | 120 | 287,58 | 431,82 | 475,00 |
| 2100 200 02XX | Mek+Tuş İkili Topraklı Priz Porselen  | 5  | 50  | 431,82 | 545,45 | 600,00 |
| 2100 201 02XX | Mek+Tuş İkili Topraksız Priz Porselen | 5  | 50  | 363,64 | 409,09 | 450,00 |
| 2100 202 02XX | Mek+Tuş İkili Topraklı Priz           | 5  | 50  | 345,45 | 409,09 | 450,00 |
| 2100 203 02XX | Mek+Tuş İkili Topraksız Priz          | 5  | 50  | 295,45 | 340,91 | 375,00 |
| 2100 215 01XX | Mek+Tuş İkili Ups Priz                | 5  | 50  | 340,91 | 431,82 | 475,00 |
| 2100 448 01XX | Mek+Tuş Tekli Usb Şarj Prizi          | 5  | 50  | 590,52 | 750,00 | 825,00 |
| 2100 469 01XX | Mek+Tuş İkili Usb + Type-C Şarj Prizi | 5  | 50  | 750,00 | 863,64 | 950,00 |



## Candelā

### Mekanizma + Tuş Ürün Listesi

| Kod                   | Ürün Tanımı                               | Kutu Adedi | Koli Adedi | Beyaz/Krem Fiyat (₺) | Metalik Fiyat (₺) | Ahşap Fiyat (₺) |
|-----------------------|---|------------|------------|----------------------|-------------------|-----------------|
| <b>İletişim Grubu</b> |   |            |            |                      |                   |                 |
| 2100 125 01XX         | Mek+Tuş Telefon Prizi 1XRj11 (Cat3)       | 12         | 120        | 190,91               | 304,55            | 335,00          |
| 2100 126 01XX         | Mek+Tuş Telefon Prizi 2XRj11 (Cat3)       | 12         | 120        | 318,18               | 440,91            | 485,00          |
| 2100 128 01XX         | Mek+Tuş Etiketli Tlf Data Priz (Kon.süz)  | 12         | 120        | 136,36               | 197,73            | 217,50          |
| 2100 135 01XX         | Mek+Tuş Data Prizi 1*Rj45 (Kon.süz)       | 12         | 120        | 136,36               | 177,95            | 195,75          |
| 2100 136 01XX         | Mek+Tuş Data Prizi 1*Rj45 (Cat5e)         | 12         | 120        | 500,00               | 590,91            | 650,00          |
| 2100 137 01XX         | Mek+Tuş Data Prizi 2*Rj45 (Kon.süz)       | 12         | 120        | 145,45               | 184,55            | 203,00          |
| 2100 138 01XX         | Mek+Tuş Data Prizi 2*Rj45 (Cat5e)         | 12         | 120        | 727,27               | 818,18            | 900,00          |
| 2100 139 01XX         | Mek+Tuş Tlf Data Priz (Rj11 Cat3 + Cat5e) | 12         | 120        | 590,91               | 750,00            | 825,00          |
| 2100 140 01XX         | Mek+Tuş Data Prizi 1*Rj45 (Cat6)          | 12         | 120        | 500,00               | 590,91            | 650,00          |
| 2100 141 01XX         | Mek+Tuş Data Prizi 2*Rj45 (Cat6)          | 12         | 120        | 727,27               | 818,18            | 900,00          |
| 2100 455 01XX         | Mek+Tuş 1*USB Priz                        | 12         | 120        | 423,79               | 527,27            | 580,00          |
| 2100 456 01XX         | Mek+Tuş 2*USB Priz                        | 12         | 120        | 723,12               | 922,73            | 1.015,00        |
| 2100 457 01XX         | Mek+Tuş 1*HDMI Priz                       | 12         | 120        | 563,06               | 725,00            | 797,50          |
| 2100 458 01XX         | Mek+Tuş 2*HDMI Priz                       | 12         | 120        | 1.016,90             | 1.285,23          | 1.413,75        |
| 2100 459 01XX         | Mek+Tuş 1*USB/1*HDMI Priz                 | 12         | 120        | 1.152,03             | 1.515,91          | 1.667,50        |
| 2100 460 01XX         | Mek+Tuş VGA Priz                          | 12         | 120        | 1.208,93             | 1.515,91          | 1.667,50        |
| 2100 121 02XX         | Mek+Tuş Kör Kapak                         | 12         | 120        | 92,65                | 159,09            | 175,00          |



### Elektronik Grubu

|               |                                       |   |    |          |          |          |
|---------------|---------------------------------------|---|----|----------|----------|----------|
| 2100 450 01XX | Mek+Tuş Energy Saver G.siz Işıklı     | 8 | 80 | 1.000,00 | 1.212,25 | 1.333,48 |
| 2100 452 01XX | Mek+Tuş Energy Saver Gecikmeli Işıklı | 8 | 80 | 1.000,00 | 1.276,05 | 1.403,66 |
| 2100 470 02XX | Mek+Tuş Müzik Yayın Anahtarı          | 8 | 80 | 1.422,09 | 1.515,01 | 1.666,51 |
| 2100 480 01XX | Mek+Tuş Hoparlör Prizi                | 8 | 80 | 278,57   | 403,91   | 444,30   |
| 2100 485 02XX | Mek+Tuş Uyanı Zili                    | 8 | 80 | 2.135,09 | 2.329,15 | 2.562,06 |
| 2100 495 02XX | Mek+Tuş Hareket Sensörü               | 8 | 80 | 2.045,45 | 2.144,75 | 2.359,22 |

### TV / SAT Grubu

|               |   |    |     |        |          |          |
|---------------|---|----|-----|--------|----------|----------|
| 2100 156 02XX | Mek+Tuş Tv-Sat Prizi (Geçişli) 4DB/F Kon. | 12 | 120 | 863,64 | 1.090,91 | 1.200,00 |
| 2100 157 02XX | Mek+Tuş Tv-Sat Prizi (Sonlu)              | 12 | 120 | 863,64 | 1.090,91 | 1.200,00 |
| 2100 166 01XX | Mek+Tuş Sat Prizi (Geçişli) 4DB/F Kon.    | 12 | 120 | 795,45 | 909,09   | 1.000,00 |
| 2100 167 01XX | Mek+Tuş Sat Prizi (Sonlu)                 | 12 | 120 | 795,45 | 909,09   | 1.000,00 |
| 2100 170 01XX | Mek+Tuş Tv Prizi (Geçişli) 11DB           | 12 | 120 | 272,73 | 318,18   | 350,00   |
| 2100 171 01XX | Mek+Tuş Tv Prizi (Sonlu)                  | 12 | 120 | 272,73 | 318,18   | 350,00   |
| 2100 172 01XX | Mek+Tuş Tv Prizi F Dişi                   | 12 | 120 | 204,55 | 272,73   | 300,00   |



### Çerçeveler

|               |                         |    |     |        |        |        |
|---------------|-------------------------|----|-----|--------|--------|--------|
| 2125 800 11XX | Tekli Çerçeve           | 20 | 400 | 21,59  | 86,36  | 95,00  |
| 2125 800 12XX | İkili Yatay Çerçeve     | 10 | 200 | 122,73 | 181,82 | 200,00 |
| 2125 800 13XX | Üçlü Yatay Çerçeve      | 10 | 50  | 159,09 | 250,00 | 275,00 |
| 2125 800 14XX | Dörtlü Yatay Çerçeve    | 10 | 50  | 195,45 | 318,18 | 350,00 |
| 2125 800 15XX | Beşli Yatay Çerçeve     | 10 | 50  | 245,45 | 386,36 | 425,00 |
| 2125 800 16XX | Altılı Yatay Çerçeve    | 10 | 50  | 295,45 | 454,55 | 500,00 |
| 2125 800 22XX | İkili Dikey Çerçeve     | 10 | 50  | 122,73 | 181,82 | 200,00 |
| 2125 800 23XX | Üçlü Dikey Çerçeve      | 10 | 50  | 159,09 | 250,00 | 275,00 |
| 2125 800 24XX | Dörtlü Dikey Çerçeve    | 10 | 50  | 195,45 | 318,18 | 350,00 |
| 2125 800 25XX | Beşli Dikey Çerçeve     | 10 | 50  | 245,45 | 386,36 | 425,00 |
| 2125 800 26XX | Altılı Dikey Çerçeve    | 10 | 50  | 295,45 | 454,55 | 500,00 |
| 2125 820 12XX | İkili Priz Çerçeve      | 12 | 60  | 86,36  | 136,36 | 150,00 |
| 2200 000 0001 | IP44 Kapaklı Priz Conta | 24 | 120 | 45,45  | -      | -      |



### İngiliz Tip

|               |                                   |    |     |        |   |   |
|---------------|-----------------------------------|----|-----|--------|---|---|
| 2190 500 0201 | İngiliz Tipi Anahtarlı Priz Beyaz | 12 | 120 | 595,00 | - | - |
|---------------|-----------------------------------|----|-----|--------|---|---|

## BELLA Serisi

### Beyaz / Gri Ürün Listesi



Beyaz 01

Gri 03

| Kod                  | Ürün Tanımı                | Kutu Adedi | Koli Adedi | Fiyat (₺) |
|----------------------|----------------------------|------------|------------|-----------|
| <b>Anahtar Grubu</b> |                            |            |            |           |
| 2151 001 02XX        | Anahtar                    | 8          | 80         | 210,50    |
| 2151 002 02XX        | Komütatör                  | 8          | 80         | 246,08    |
| 2151 003 02XX        | Vavien (İki Yollu Anahtar) | 8          | 80         | 237,29    |
| 2151 005 02XX        | Çift Kutuplu Anahtar       | 8          | 80         | 277,93    |
| 2151 006 02XX        | Jaluzi Anahtar             | 8          | 80         | 325,44    |
| 2151 007 02XXX       | Kapı Otomatığı Anahtar     | 8          | 80         | 222,65    |
| 2151 007 02XXZ       | Zil Anahtar                | 8          | 80         | 222,65    |
| 2151 007 02XX        | Çağırma Anahtar            | 8          | 80         | 222,65    |
| 2151 008 02XX        | Deviatör (Ara Vavien)      | 8          | 80         | 341,98    |

|                   |                                   |   |    |        |
|-------------------|-----------------------------------|---|----|--------|
| <b>Priz Grubu</b> |                                   |   |    |        |
| 2151 180 02XX     | Kapaklı Topraklı Priz             | 8 | 80 | 245,41 |
| 2151 210 02XX     | Kapaklı Topraklı İkili Priz       | 8 | 80 | 431,82 |
| 2151 220 02XX     | Kapaklı Topraklı İkili Dikey Priz | 8 | 80 | 431,82 |
| 2151 511 02XX     | İkili Anahtar + Topraklı Priz     | 4 | 40 | 454,55 |
| 2151 521 02XX     | İkili Komitatör + Topraklı Priz   | 4 | 40 | 500,00 |

|                       |                     |   |    |        |
|-----------------------|---------------------|---|----|--------|
| <b>TV / SAT Grubu</b> |                     |   |    |        |
| 2151 166 02XX         | Sat Prizi (Geçişli) | 8 | 80 | 351,42 |
| 2151 167 02XX         | Sat Prizi (Sonlu)   | 8 | 80 | 351,42 |
| 2151 170 02XX         | TV Prizi (Geçişli)  | 8 | 80 | 343,39 |
| 2151 171 02XX         | TV Prizi (Sonlu)    | 8 | 80 | 343,39 |

|                   |              |   |    |        |
|-------------------|--------------|---|----|--------|
| <b>Buat Grubu</b> |              |   |    |        |
| 2151 000 01XX     | 6 Çıkış Buat | 8 | 80 | 214,20 |

## BELLA Serisi

### Ahşap Ürün Listesi



Armut 49

Maun 44

K. Ceviz 41

A. Kayın 40

| Kod                  | Ürün Tanımı                      | Kutu Adedi | Koli Adedi | Fiyat (₺) |
|----------------------|----------------------------------|------------|------------|-----------|
| <b>Anahtar Grubu</b> |                                  |            |            |           |
| 2151 001 02XX        | Anahtar Ahşap                    | 8          | 80         | 263,13    |
| 2151 002 02XX        | Komütatör Ahşap                  | 8          | 80         | 307,60    |
| 2151 003 02XX        | Vavien (İki Yollu Anahtar) Ahşap | 8          | 80         | 296,61    |
| 2151 005 02XX        | Çift Kutuplu Anahtar Ahşap       | 8          | 80         | 347,41    |
| 2151 006 02XX        | Jaluzi Anahtar Ahşap             | 8          | 80         | 406,80    |
| 2151 007 02XX        | Çağırma Anahtar Ahşap            | 8          | 80         | 278,32    |
| 2151 007 02XXX       | Kapı Otomatığı Anahtar Ahşap     | 8          | 80         | 278,32    |
| 2151 007 02XXZ       | Zil Anahtar Ahşap                | 8          | 80         | 278,32    |
| 2151 008 02XX        | Deviatör (Ara Vavien)            | 8          | 80         | 427,47    |

|                   |                                   |   |    |        |
|-------------------|-----------------------------------|---|----|--------|
| <b>Priz Grubu</b> |                                   |   |    |        |
| 2151 180 02XX     | Kapaklı Topraklı Priz             | 8 | 80 | 306,76 |
| 2151 210 02XX     | Kapaklı Topraklı İkili Priz       | 8 | 80 | 539,77 |
| 2151 220 02XX     | Kapaklı Topraklı İkili Dikey Priz | 8 | 80 | 539,77 |
| 2151 511 02XX     | İkili Anahtar + Topraklı Priz     | 4 | 40 | 568,18 |
| 2151 521 02XX     | İkili Komitatör + Topraklı Priz   | 4 | 40 | 625,00 |

|                       |                     |   |    |        |
|-----------------------|---------------------|---|----|--------|
| <b>TV / SAT Grubu</b> |                     |   |    |        |
| 2151 166 02XX         | Sat Prizi (Geçişli) | 8 | 80 | 439,28 |
| 2151 167 02XX         | Sat Prizi (Sonlu)   | 8 | 80 | 439,28 |
| 2151 170 02XX         | TV Prizi (Geçişli)  | 8 | 80 | 429,24 |
| 2151 171 02XX         | TV Prizi (Sonlu)    | 8 | 80 | 429,24 |

|                   |              |   |    |        |
|-------------------|--------------|---|----|--------|
| <b>Buat Grubu</b> |              |   |    |        |
| 2151 000 01XX     | 6 Çıkış Buat | 8 | 80 | 267,76 |

# NORA Serisi

Beyaz / Gri Ürün Listesi

| Kod                  | Ürün Tanımı                | Kutu Adedi | Koli Adedi | Fiyat (₺) |
|----------------------|----------------------------|------------|------------|-----------|
| <b>Anahtar Grubu</b> |                            |            |            |           |
| 2155 001 02XX        | Anahtar                    | 8          | 80         | 260,83    |
| 2155 002 02XX        | Komütatör                  | 8          | 80         | 326,05    |
| 2155 003 02XX        | Vavien (İki Yollu Anahtar) | 8          | 80         | 295,16    |
| 2155 004 02XX        | Komütatör Vavien           | 8          | 80         | 383,91    |
| 2155 005 02XX        | Çift Kutuplu Anahtar       | 8          | 80         | 334,66    |
| 2155 006 02XX        | Jaluzi Anahtar             | 8          | 80         | 397,73    |
| 2155 007 02XX        | Çağırma Anahtarı           | 8          | 80         | 293,85    |
| 2155 007 02XXZ       | Zil Anahtarı               | 8          | 80         | 293,85    |
| 2155 008 02XX        | Deviatör (Ara Vavien)      | 8          | 80         | 404,94    |
| 2155 037 02XX        | Acil Çağırma (İpli)        | 8          | 80         | 450,20    |

## Priz Grubu

|               |  |   |    |        |
|---------------|--|---|----|--------|
| 2155 180 02XX | Kapaklı Topraklı Priz                      | 8 | 80 | 282,56 |
| 2155 187 02XX | Kapaklı Topraklı UPS Priz                  | 8 | 80 | 285,20 |
| 2155 188 02XX | Kapaklı Topraklı UPS Priz (Çocuk Korumalı) | 8 | 80 | 306,67 |
| 2155 210 02XX | Kapaklı Topraklı İkili Priz                | 4 | 40 | 511,46 |
| 2155 217 02XX | Kapaklı Topraklı İkili UPS Priz            | 4 | 40 | 460,42 |
| 2155 220 02XX | Kapaklı Topraklı İkili Dikey Priz          | 4 | 40 | 510,34 |
| 2155 227 02XX | Kapaklı Topraklı İkili Dikey UPS Priz      | 4 | 40 | 524,70 |
| 2155 511 02XX | İkili Anahtar + Topraklı Priz              | 4 | 40 | 539,38 |
| 2155 521 02XX | İkili Komitatör + Topraklı Priz            | 4 | 40 | 584,48 |

## TV / SAT Grubu

|               |                     |   |    |        |
|---------------|---------------------|---|----|--------|
| 2155 166 02XX | Sat Prizi (Geçişli) | 8 | 80 | 450,50 |
| 2155 167 02XX | Sat Prizi (Sonlu)   | 8 | 80 | 450,51 |
| 2155 170 02XX | TV Prizi (Geçişli)  | 8 | 80 | 417,15 |
| 2155 171 02XX | TV Prizi (Sonlu)    | 8 | 80 | 417,73 |

## Buat Grubu

|               |              |   |    |        |
|---------------|--------------|---|----|--------|
| 2155 000 01XX | 4 Çıkış Buat | 8 | 80 | 233,19 |
|---------------|--------------|---|----|--------|



Beyaz 01

Gri 03

**BRON Natural SIVA ÜSTÜ ANAHTAR PRİZ SERİSİ**

| Kod           | Ürün Tanımı                                  | Kutu Adedi | Koli Adedi | Fiyat (₺) |
|---------------|--|------------|------------|-----------|
| 2160 301 02XX | Bron S/Ü Anahtar                             | 12         | 120        | 204,55    |
| 2160 302 02XX | Bron S/Ü Komütatör                           | 12         | 120        | 263,64    |
| 2160 303 02XX | Bron S/Ü Vavien                              | 12         | 120        | 295,45    |
| 2160 307 02XX | Bron S/Ü Light (Çağırma)                     | 12         | 120        | 209,09    |
| 2160 315 02XX | Bron S/Ü Işıklı Anahtar (220V)               | 12         | 120        | 259,09    |
| 2160 316 02XX | Bron S/Ü Işıklı Vavien (220V)                | 12         | 120        | 340,91    |
| 2160 317 02XX | Bron S/Ü Işıklı Light (Çağırma) (220V)       | 12         | 120        | 276,09    |
| 2160 326 02XX | Bron S/Ü Işıklı Komütatör                    | 12         | 120        | 316,75    |
| 2160 100 02XX | Bron S/Ü Topraklı Priz                       | 12         | 120        | 235,95    |
| 2160 101 02XX | Bron S/Ü Topraksız Priz                      | 12         | 120        | 204,55    |
| 2160 103 02XX | Bron S/Ü Topraklı Priz Porselen              | 12         | 120        | 315,42    |
| 2160 104 02XX | Bron S/Ü Topraksız Priz Porselen             | 12         | 120        | 273,14    |
| 2160 110 02XX | Bron S/Ü Kapaklı Topraklı Priz               | 10         | 100        | 272,73    |
| 2160 113 02XX | Bron S/Ü Kapaklı Topraklı Priz Porselen      | 10         | 100        | 338,21    |
| 2160 115 02XX | Bron S/Ü Ups (Fransız) Priz                  | 12         | 120        | 257,00    |
| 2160 125 02XX | Bron S/Ü Telefon Prizi 1*Rj11 Cat3           | 12         | 120        | 181,82    |
| 2160 136 02XX | Bron S/Ü Data Prizi 1*Rj45 (Cat5)            | 12         | 120        | 204,55    |
| 2160 140 02XX | Bron S/Ü Data Prizi 1*Rj45 (Cat6)            | 12         | 120        | 204,55    |
| 2160 166 02XX | Bron S/Ü Sat Prizi (Geçişli) 4Db/F Konnektör | 12         | 120        | 363,64    |
| 2160 167 02XX | Bron S/Ü Sat Prizi (Sonlu)                   | 12         | 120        | 363,64    |
| 2160 170 02XX | Bron S/Ü Tv Prizi (Geçişli)                  | 12         | 120        | 363,64    |
| 2160 171 02XX | Bron S/Ü Tv Prizi (Sonlu)                    | 12         | 120        | 363,64    |
| 2160 200 02XX | Bron S/Ü İkili Topraklı Priz Porselen        | 6          | 60         | 386,52    |
| 2160 201 02XX | Bron S/Ü İkili Topraksız Priz Porselen       | 6          | 60         | 345,24    |
| 2160 202 02XX | Bron S/Ü İkili Topraklı Priz                 | 6          | 60         | 337,85    |
| 2160 203 02XX | Bron S/Ü İkili Topraksız Priz                | 6          | 60         | 294,90    |
| 2160 215 02XX | Bron S/Ü İkili Ups (Fransız) Priz            | 6          | 60         | 334,50    |



Beyaz  
 Krem  
 01      02

## Meşe / Ceviz Ürün Listesi

**BRON Ahşap SIVA ÜSTÜ ANAHTAR PRİZ SERİSİ**

| Kod           | Ürün Tanımı                                  | Kutu Adedi | Koli Adedi | Fiyat (₺) |
|---------------|--|------------|------------|-----------|
| 2160 301 02XX | Bron S/Ü Anahtar                             | 12         | 120        | 272,73    |
| 2160 302 02XX | Bron S/Ü Komütatör                           | 12         | 120        | 340,91    |
| 2160 303 02XX | Bron S/Ü Vavien                              | 12         | 120        | 363,64    |
| 2160 307 02XX | Bron S/Ü Light (Çağırma)                     | 12         | 120        | 272,73    |
| 2160 315 02XX | Bron S/Ü Işıklı Anahtar (220V)               | 12         | 120        | 327,27    |
| 2160 316 02XX | Bron S/Ü Işıklı Vavien (220V)                | 12         | 120        | 409,09    |
| 2160 317 02XX | Bron S/Ü Işıklı Light (Çağırma) (220V)       | 12         | 120        | 340,91    |
| 2160 326 02XX | Bron S/Ü Işıklı Komütatör                    | 12         | 120        | 386,36    |
| 2160 100 02XX | Bron S/Ü Topraklı Priz                       | 12         | 120        | 295,45    |
| 2160 101 02XX | Bron S/Ü Topraksız Priz                      | 12         | 120        | 272,73    |
| 2160 103 02XX | Bron S/Ü Topraklı Priz Porselen              | 12         | 120        | 363,64    |
| 2160 104 02XX | Bron S/Ü Topraksız Priz Porselen             | 12         | 120        | 318,18    |
| 2160 110 02XX | Bron S/Ü Kapaklı Topraklı Priz               | 10         | 100        | 363,64    |
| 2160 113 02XX | Bron S/Ü Kapaklı Topraklı Priz Porselen      | 10         | 100        | 431,82    |
| 2160 115 02XX | Bron S/Ü Ups (Fransız) Priz                  | 12         | 120        | 318,18    |
| 2160 125 02XX | Bron S/Ü Telefon Prizi 1*Rj11 Cat3           | 12         | 120        | 250,00    |
| 2160 136 02XX | Bron S/Ü Data Prizi 1*Rj45 (Cat5)            | 12         | 120        | 295,45    |
| 2160 140 02XX | Bron S/Ü Data Prizi 1*Rj45 (Cat6)            | 12         | 120        | 295,45    |
| 2160 166 02XX | Bron S/Ü Sat Prizi (Geçişli) 4Db/F Konnektör | 12         | 120        | 409,09    |
| 2160 167 02XX | Bron S/Ü Sat Prizi (Sonlu)                   | 12         | 120        | 409,09    |
| 2160 170 02XX | Bron S/Ü Tv Prizi (Geçişli)                  | 12         | 120        | 409,09    |
| 2160 171 02XX | Bron S/Ü Tv Prizi (Sonlu)                    | 12         | 120        | 409,09    |
| 2160 200 02XX | Bron S/Ü İkili Topraklı Priz Porselen        | 6          | 60         | 431,82    |
| 2160 201 02XX | Bron S/Ü İkili Topraksız Priz Porselen       | 6          | 60         | 386,36    |
| 2160 202 02XX | Bron S/Ü İkili Topraklı Priz                 | 6          | 60         | 363,64    |
| 2160 203 02XX | Bron S/Ü İkili Topraksız Priz                | 6          | 60         | 340,91    |
| 2160 215 02XX | Bron S/Ü İkili Ups (Fransız) Priz            | 6          | 60         | 363,64    |



Meşe  
 Ceviz  
 58      57

## Ri-tech Grup Prizler

| Kod                  | Ürün Tanımı   | Kutu Adedi | Fiyat (₺) |
|----------------------|---|------------|-----------|
| 001 175 210001 00 00 | İkili Topraklı Grup Priz (Çocuk Korumalı)(Klemensli)                      | 25         | 318,18    |
| 001 175 210002 01 00 | İkili Topraklı Grup Priz (Çocuk Korumalı)(1 m)                            | 12         | 636,36    |
| 001 175 210002 02 00 | İkili Topraklı Grup Priz (Çocuk Korumalı)(2 m)                            | 12         | 772,73    |
| 001 175 210002 03 00 | İkili Topraklı Grup Priz (Çocuk Korumalı)(3 m)                            | 12         | 931,82    |
| 001 175 210002 05 00 | İkili Topraklı Grup Priz (Çocuk Korumalı)(5 m)                            | 12         | 1.204,55  |
| 001 175 220001 00 00 | İkili Anahtarlı Topraklı Grup Priz (Çocuk Korumalı)(Klemensli)            | 25         | 590,91    |
| 001 175 220002 01 00 | İkili Anahtarlı Topraklı Grup Priz (Çocuk Korumalı)(1 m)                  | 12         | 1.000,00  |
| 001 175 220002 02 00 | İkili Anahtarlı Topraklı Grup Priz (Çocuk Korumalı)(2 m)                  | 12         | 1.136,36  |
| 001 175 220002 03 00 | İkili Anahtarlı Topraklı Grup Priz (Çocuk Korumalı)(3 m)                  | 12         | 1.340,91  |
| 001 175 220002 05 00 | İkili Anahtarlı Topraklı Grup Priz (Çocuk Korumalı)(5 m)                  | 12         | 1.636,36  |
| 001 175 310001 00 00 | Üçlü Topraklı Grup Priz (Çocuk Korumalı)(Klemensli)                       | 25         | 363,64    |
| 001 175 310002 01 00 | Üçlü Topraklı Grup Priz (Çocuk Korumalı)(1 m)                             | 12         | 704,55    |
| 001 175 310002 02 00 | Üçlü Topraklı Grup Priz (Çocuk Korumalı)(2 m)                             | 12         | 886,36    |
| 001 175 310002 03 00 | Üçlü Topraklı Grup Priz (Çocuk Korumalı)(3 m)                             | 12         | 1.045,45  |
| 001 175 310002 05 00 | Üçlü Topraklı Grup Priz (Çocuk Korumalı)(5 m)                             | 12         | 1.363,64  |
| 001 175 320001 00 00 | Üçlü Anahtarlı Topraklı Grup Priz (Çocuk Korumalı)(Klemensli)             | 25         | 659,09    |
| 001 175 320002 01 00 | Üçlü Anahtarlı Topraklı Grup Priz (Çocuk Korumalı)(1 m)                   | 12         | 1.090,91  |
| 001 175 320002 02 00 | Üçlü Anahtarlı Topraklı Grup Priz (Çocuk Korumalı)(2 m)                   | 12         | 1.204,55  |
| 001 175 320002 03 00 | Üçlü Anahtarlı Topraklı Grup Priz (Çocuk Korumalı)(3 m)                   | 12         | 1.431,82  |
| 001 175 320002 05 00 | Üçlü Anahtarlı Topraklı Grup Priz (Çocuk Korumalı)(5 m)                   | 12         | 1.763,64  |
| 001 175 350101 00 00 | Üçlü Usb + Type-C Anaht. Topraklı Grup Priz (Çocuk Korumalı)(Klemensli)   | 25         | 1.718,18  |
| 001 175 350102 02 00 | Üçlü Usb + Type-C Anahtarlı Topraklı Grup Priz (Çocuk Korumalı)(2 m)      | 12         | 2.243,18  |
| 001 175 350102 03 00 | Üçlü Usb + Type-C Anahtarlı Topraklı Grup Priz (Çocuk Korumalı)(3 m)      | 12         | 2.481,82  |
| 001 175 350102 05 00 | Üçlü Usb + Type-C Anahtarlı Topraklı Grup Priz (Çocuk Korumalı)(5 m)      | 12         | 2.863,64  |
| 001 175 410001 00 00 | Dörtlü Topraklı Grup Priz (Çocuk Korumalı)(Klemensli)                     | 25         | 454,55    |
| 001 175 410002 01 00 | Dörtlü Topraklı Grup Priz (Çocuk Korumalı)(1 m)                           | 12         | 863,64    |
| 001 175 410002 02 00 | Dörtlü Topraklı Grup Priz (Çocuk Korumalı)(2 m)                           | 12         | 1.000,00  |
| 001 175 410002 03 00 | Dörtlü Topraklı Grup Priz (Çocuk Korumalı)(3 m)                           | 12         | 1.181,82  |
| 001 175 410002 05 00 | Dörtlü Topraklı Grup Priz (Çocuk Korumalı)(5 m)                           | 12         | 1.477,27  |
| 001 175 420001 00 00 | Dörtlü Anahtarlı Topraklı Grup Priz (Çocuk Korumalı)(Klemensli)           | 25         | 772,73    |
| 001 175 420002 01 00 | Dörtlü Anahtarlı Topraklı Grup Priz (Çocuk Korumalı)(1 m)                 | 12         | 1.295,45  |
| 001 175 420002 02 00 | Dörtlü Anahtarlı Topraklı Grup Priz (Çocuk Korumalı)(2 m)                 | 12         | 1.409,09  |
| 001 175 420002 03 00 | Dörtlü Anahtarlı Topraklı Grup Priz (Çocuk Korumalı)(3 m)                 | 12         | 1.636,36  |
| 001 175 420002 05 00 | Dörtlü Anahtarlı Topraklı Grup Priz (Çocuk Korumalı)(5 m)                 | 12         | 1.909,09  |
| 001 175 610001 00 00 | Altılı Topraklı Grup Priz (Çocuk Korumalı)(Klemensli)                     | 25         | 727,27    |
| 001 175 610002 01 00 | Altılı Topraklı Grup Priz (Çocuk Korumalı)(1 m)                           | 12         | 1.204,55  |
| 001 175 610002 02 00 | Altılı Topraklı Grup Priz (Çocuk Korumalı)(2 m)                           | 12         | 1.409,09  |
| 001 175 610002 03 00 | Altılı Topraklı Grup Priz (Çocuk Korumalı)(3 m)                           | 12         | 1.636,36  |
| 001 175 610002 05 00 | Altılı Topraklı Grup Priz (Çocuk Korumalı)(5 m)                           | 12         | 2.000,00  |
| 001 175 620001 00 00 | Altılı Anahtarlı Topraklı Grup Priz (Çocuk Korumalı)(Klemensli)           | 25         | 954,55    |
| 001 175 620002 01 00 | Altılı Anahtarlı Topraklı Grup Priz (Çocuk Korumalı)(1 m)                 | 12         | 1.545,45  |
| 001 175 620002 02 00 | Altılı Anahtarlı Topraklı Grup Priz (Çocuk Korumalı)(2 m)                 | 12         | 1.704,55  |
| 001 175 620002 03 00 | Altılı Anahtarlı Topraklı Grup Priz (Çocuk Korumalı)(3 m)                 | 12         | 1.909,09  |
| 001 175 620002 05 00 | Altılı Anahtarlı Topraklı Grup Priz (Çocuk Korumalı)(5 m)                 | 12         | 2.272,73  |
| 001 175 650101 00 00 | Altılı Usb + Type-C Anaht. Topraklı Grup Priz (Çocuk Korumalı)(Klemensli) | 25         | 2.000,00  |
| 001 175 650102 02 00 | Altılı Usb + Type-C Anahtarlı Topraklı Grup Priz (Çocuk Korumalı)(2 m)    | 12         | 2.727,27  |
| 001 175 650102 03 00 | Altılı Usb + Type-C Anahtarlı Topraklı Grup Priz (Çocuk Korumalı)(3 m)    | 12         | 2.954,55  |
| 001 175 650102 05 00 | Altılı Usb + Type-C Anahtarlı Topraklı Grup Priz (Çocuk Korumalı)(5 m)    | 12         | 3.340,91  |

## Ri-tech Grup Prizler

| Kod                  | Ürün Tanımı  | Kutu Adedi | Fiyat (₺) |
|----------------------|--|------------|-----------|
| 001 175 330001 00 00 | Üçlü Ups Grup Priz (Çocuk Koruma)(Klemensli)             | 25         | 477,27    |
| 001 175 330002 02 00 | Üçlü Ups Grup Priz (Çocuk Koruma)(2 m)                   | 12         | 1.113,64  |
| 001 175 330002 03 00 | Üçlü Ups Grup Priz (Çocuk Koruma)(3 m)                   | 12         | 1.304,31  |
| 001 175 330002 05 00 | Üçlü Ups Grup Priz (Çocuk Koruma)(5 m)                   | 12         | 1.716,51  |
| 001 175 340001 00 00 | Üçlü Anahtarlı Ups Grup Priz (Çocuk Koruma)(Klemensli)   | 25         | 750,00    |
| 001 175 340002 02 00 | Üçlü Anahtarlı Ups Grup Priz (Çocuk Koruma)(2 m)         | 12         | 1.340,91  |
| 001 175 340002 03 00 | Üçlü Anahtarlı Ups Grup Priz (Çocuk Koruma)(3 m)         | 12         | 1.505,89  |
| 001 175 340002 05 00 | Üçlü Anahtarlı Ups Grup Priz (Çocuk Koruma)(5 m)         | 12         | 1.787,07  |
| 001 175 430001 00 00 | Dörtlü Ups Grup Priz (Çocuk Koruma)(Klemensli)           | 25         | 727,27    |
| 001 175 430002 02 00 | Dörtlü Ups Grup Priz (Çocuk Koruma)(2 m)                 | 12         | 1.454,55  |
| 001 175 430002 03 00 | Dörtlü Ups Grup Priz (Çocuk Koruma)(3 m)                 | 12         | 1.500,00  |
| 001 175 430002 05 00 | Dörtlü Ups Grup Priz (Çocuk Koruma)(5 m)                 | 12         | 1.818,18  |
| 001 175 440001 00 00 | Dörtlü Anahtarlı Ups Grup Priz (Çocuk Koruma)(Klemensli) | 25         | 1.136,36  |
| 001 175 440002 02 00 | Dörtlü Anahtarlı Ups Grup Priz (Çocuk Koruma)(2 m)       | 12         | 1.727,27  |
| 001 175 440002 03 00 | Dörtlü Anahtarlı Ups Grup Priz (Çocuk Koruma)(3 m)       | 12         | 2.000,00  |
| 001 175 440002 05 00 | Dörtlü Anahtarlı Ups Grup Priz (Çocuk Koruma)(5 m)       | 12         | 2.272,73  |
| 001 175 630001 00 00 | Altılı Ups Grup Priz (Çocuk Koruma)(Klemensli)           | 25         | 798,46    |
| 001 175 630002 02 00 | Altılı Ups Grup Priz (Çocuk Koruma)(2 m)                 | 12         | 1.567,77  |
| 001 175 630002 03 00 | Altılı Ups Grup Priz (Çocuk Koruma)(3 m)                 | 12         | 1.852,32  |
| 001 175 630002 05 00 | Altılı Ups Grup Priz (Çocuk Koruma)(5 m)                 | 12         | 2.431,80  |
| 001 175 640001 00 00 | Altılı Anahtarlı Ups Grup Priz (Çocuk Koruma)(Klemensli) | 25         | 1.271,29  |
| 001 175 640002 02 00 | Altılı Anahtarlı Ups Grup Priz (Çocuk Koruma)(2 m)       | 12         | 2.046,97  |
| 001 175 640002 03 00 | Altılı Anahtarlı Ups Grup Priz (Çocuk Koruma)(3 m)       | 12         | 2.331,86  |
| 001 175 640002 05 00 | Altılı Anahtarlı Ups Grup Priz (Çocuk Koruma)(5 m)       | 12         | 2.911,92  |



ALTILI ŞOK KORUMALI  
USB ANAHTAR TOPRAKLI  
GRUP PRİZ



ANAHTAR PRİZ GRUBU

## Ri-tech Akım (Şok) Korumalı Grup Priz

| Kod                  | Ürün Tanımı  | Kutu Adedi | Fiyat (₺) |
|----------------------|--|------------|-----------|
| 001 175 660002 15 00 | Altılı Şok Koruma USB Anahtarlı Topraklı Grup Priz (Ç.K.)(3X1.5 1.5 m) | 12         | 2.636,36  |
| 001 175 670002 15 00 | Altılı Şok Koruma Anahtarlı Topraklı Grup Priz (Ç.K.) (3X1.5 1.5 m)    | 12         | 2.159,09  |
| 001 175 370002 15 00 | Üçlü Şok Koruma Anahtarlı Topraklı Grup Priz (Ç.K.) (3X1.5 1.5 m)      | 12         | 1.954,55  |
| 001 175 370002 03 00 | Üçlü Şok Koruma Anahtarlı Topraklı Grup Priz (Ç.K.) (3X1.5 3 m)        | 12         | 2.250,00  |
| 001 888 100004 00 00 | Tekli Şok Korumalı Priz  | 12         | 818,18    |



TEKLI ŞOK KORUMALI PRİZ



USB + TYPE-C  
ŞARJ ADAPTÖR

## Ri-tech USB Şarj

| Kod                  | Ürün Tanımı                    | Kutu Adedi | Fiyat (₺) |
|----------------------|--------------------------------|------------|-----------|
| 001 888 100002 00 00 | 2'Li USB ŞARJ ADAPTÖR 2,4A     | 20         | 500,00    |
| 001 888 100003 00 00 | USB + TYPE-C ŞARJ ADAPTÖR 2,4A | 20         | 568,18    |



\* Çoklu çerçeve ile kullanılamaz.

| Kod           | Ürün Tanımı                                    | Kutu Adedi | Koli Adedi | Beyaz/Krem Fiyat (₺) | Metalik Fiyat (₺) | Ahşap Fiyat (₺) |
|---------------|--|------------|------------|----------------------|-------------------|-----------------|
| 2220 629 02XX | RİTA USB +TYPE-C TOPRAKLI PRİZ (ÇERÇEVE DAHİL) | 8          | -          | 909,09               | 1.363,64          | 1.500,00        |

## Olimpia Grup Prizler

| Kod                  | Ürün Tanımı   | Kutu Adedi | Fiyat (₺) |
|----------------------|---|------------|-----------|
| 001 171 290001 00 00 | İkili Topraksız Grup Priz (Klemensli) Olimpia           | 25         | 238,64    |
| 001 171 290002 02 00 | İkili Topraksız Grup Priz (2 m) Olimpia                 | 12         | 579,55    |
| 001 171 290002 03 00 | İkili Topraksız Grup Priz (3 m) Olimpia                 | 12         | 698,86    |
| 001 171 290002 05 00 | İkili Topraksız Grup Priz (5 m) Olimpia                 | 12         | 903,41    |
| 001 171 210001 00 00 | İkili Topraklı Grup Priz (Klemensli) Olimpia            | 25         | 318,18    |
| 001 171 210002 02 00 | İkili Topraklı Grup Priz (2 m) Olimpia                  | 12         | 772,73    |
| 001 171 210002 03 00 | İkili Topraklı Grup Priz (3 m) Olimpia                  | 12         | 931,82    |
| 001 171 210002 05 00 | İkili Topraklı Grup Priz (5 m) Olimpia                  | 12         | 1.204,55  |
| 001 171 390001 00 00 | Üçlü Topraksız Grup Priz (Klemensli) Olimpia            | 25         | 295,45    |
| 001 171 390002 02 00 | Üçlü Topraksız Grup Priz (2 m) Olimpia                  | 12         | 664,77    |
| 001 171 390002 03 00 | Üçlü Topraksız Grup Priz (3 m) Olimpia                  | 12         | 784,09    |
| 001 171 390002 05 00 | Üçlü Topraksız Grup Priz (5 m) Olimpia                  | 12         | 1.022,73  |
| 001 171 310001 00 00 | Üçlü Grup Priz Topraklı (Klemensli) Olimpia             | 25         | 363,64    |
| 001 171 310002 02 00 | Üçlü Topraklı Grup Priz (2 m) Olimpia                   | 12         | 886,36    |
| 001 171 310002 03 00 | Üçlü Topraklı Grup Priz (3 m) Olimpia                   | 12         | 1.045,45  |
| 001 171 310002 05 00 | Üçlü Topraklı Grup Priz (5 m) Olimpia                   | 12         | 1.363,64  |
| 001 171 320001 00 00 | Üçlü Topraklı Grup Priz (Klemensli Anahtarlı) Olimpia   | 25         | 659,09    |
| 001 171 320002 02 00 | Üçlü Topraklı Grup Priz (Anahtarlı 2 m) Olimpia         | 12         | 1.204,55  |
| 001 171 320002 03 00 | Üçlü Topraklı Grup Priz (Anahtarlı 3 m) Olimpia         | 12         | 1.431,82  |
| 001 171 320002 05 00 | Üçlü Topraklı Grup Priz (Anahtarlı 5 m) Olimpia         | 12         | 1.763,64  |
| 001 171 340001 00 00 | Üçlü Ups Grup Priz (Klemensli) Olimpia                  | 25         | 477,27    |
| 001 171 330001 02 00 | Üçlü Ups Grup Priz (2 m) Olimpia                        | 12         | 1.113,64  |
| 001 171 330001 03 00 | Üçlü Ups Grup Priz (3 m) Olimpia                        | 12         | 1.304,31  |
| 001 171 330001 05 00 | Üçlü Ups Grup Priz (5 m) Olimpia                        | 12         | 1.716,51  |
| 001 171 410001 00 00 | Dörtlü Topraklı Grup Priz (Klemensli) Olimpia           | 25         | 454,55    |
| 001 171 410001 02 00 | Dörtlü Topraklı Grup Priz (2 m) Olimpia                 | 12         | 1.000,00  |
| 001 171 410001 03 00 | Dörtlü Topraklı Grup Priz (3 m) Olimpia                 | 12         | 1.181,82  |
| 001 171 410001 05 00 | Dörtlü Topraklı Grup Priz (5 m) Olimpia                 | 12         | 1.477,27  |
| 001 171 410002 00 00 | Dörtlü Topraklı Grup Priz (Klemensli-Anahtarlı) Olimpia | 25         | 772,73    |
| 001 171 410002 02 00 | Dörtlü Topraklı Grup Priz (Anahtarlı 2 m) Olimpia       | 12         | 1.409,09  |
| 001 171 410002 03 00 | Dörtlü Topraklı Grup Priz (Anahtarlı 3 m) Olimpia       | 12         | 1.636,36  |
| 001 171 410002 05 00 | Dörtlü Topraklı Grup Priz (Anahtarlı 5 m) Olimpia       | 12         | 1.909,09  |
| 001 171 610001 00 00 | Altılı Grup Priz Topraklı (Klemensli) Olimpia           | 25         | 727,27    |
| 001 171 610001 02 00 | Altılı Topraklı Grup Priz (2 m) Olimpia                 | 12         | 1.409,09  |
| 001 171 610001 03 00 | Altılı Topraklı Grup Priz (3 m) Olimpia                 | 12         | 1.636,36  |
| 001 171 610001 05 00 | Altılı Topraklı Grup Priz (5 m) Olimpia                 | 12         | 2.000,00  |
| 001 171 610002 00 00 | Altılı Topraklı Grup Priz (Klemensli-Anahtarlı) Olimpia | 25         | 954,55    |
| 001 171 610002 02 00 | Altılı Topraklı Grup Priz (Anahtarlı 2 m) Olimpia       | 12         | 1.704,55  |
| 001 171 610002 03 00 | Altılı Topraklı Grup Priz (Anahtarlı 3 m) Olimpia       | 12         | 1.909,09  |
| 001 171 610002 05 00 | Altılı Topraklı Grup Priz (Anahtarlı 5 m) Olimpia       | 12         | 2.272,73  |
| 001 170 110001 00 00 | PLUS 10'lu Topraklı Grup Priz (Klemensli)               | 20         | 1.400,71  |

YENİ

# LİVA ile ENERJİYİ YÖNET!



ANAHTAR PRİZ GRUBU

## LİVA Fiş Prizler



CE

|                  |  |
|------------------|--|
| Ürün Kodu        | 001 174 250101 00 17   |
| Ürün Adı         | LİVA Topraklı İkili USB+TYPE-C Fiş Priz (Çocuk Korumalı) Yonca Tip (S/Ü) |
| Kutu /Koli Adedi | 12 / 48  |
| Fiyat (₺)        | 1.045,45   |



CE

|                  |   |
|------------------|---|
| Ürün Kodu        | 001 174 220001 00 17  |
| Ürün Adı         | LİVA Topraklı İkili Anahtarlı Fiş Priz (Çocuk Korumalı) Yonca Tip (S/Ü) |
| Kutu /Koli Adedi | 12 / 48   |
| Fiyat (₺)        | 568,18  |



CE

|                  |   |
|------------------|---|
| Ürün Kodu        | 001 174 210001 00 17  |
| Ürün Adı         | LİVA Topraklı İkili Fiş Priz (Çocuk Korumalı) Düz Tip (S/Ü) |
| Kutu /Koli Adedi | 12 / 48   |
| Fiyat (₺)        | 386,36  |



CE

|                  |  |
|------------------|--|
| Ürün Kodu        | 001 174 310001 00 17   |
| Ürün Adı         | LİVA Topraklı Üçlü Fiş Priz (Çocuk Korumalı) Yonca Tip (S/Ü) |
| Kutu /Koli Adedi | 12 / 48  |
| Fiyat (₺)        | 545,45   |

## Olimpiā Fiş Priz Aksesuarları



CE

|            |                                       |
|------------|---------------------------------------|
| Ürün Kodu  | 001 170 012001 00 00                  |
| Ürün Adı   | Olimpia Topraklı Erkek Fiş (Kuyruklu) |
| Kutu Adedi | 50                                    |
| Fiyat (₺)  | 120,45                                |



CE

|            |                      |
|------------|----------------------|
| Ürün Kodu  | 001 170 010001 00 00 |
| Ürün Adı   | Olimpia Erkek Fiş    |
| Kutu Adedi | 50                   |
| Fiyat (₺)  | 84,09                |



CE

|            |   |
|------------|---|
| Ürün Kodu  | 001 170 013001 00 00                      |
| Ürün Adı   | Olimpia Topraklı Erkek Fiş Ups (Kuyruklu) |
| Kutu Adedi | 50  |
| Fiyat (₺)  | 122,73                                    |



CE

|            |                      |
|------------|----------------------|
| Ürün Kodu  | 001 170 020001 00 00 |
| Ürün Adı   | Olimpia Dişi Fiş     |
| Kutu Adedi | 50                   |
| Fiyat (₺)  | 67,05                |



CE

|            |                            |
|------------|----------------------------|
| Ürün Kodu  | 001 170 011001 00 00       |
| Ürün Adı   | Olimpia Topraklı Erkek Fiş |
| Kutu Adedi | 50                         |
| Fiyat (₺)  | 120,45                     |



CE

|            |                           |
|------------|---------------------------|
| Ürün Kodu  | 001 170 021001 00 00      |
| Ürün Adı   | Olimpia Topraklı Dişi Fiş |
| Kutu Adedi | 25                        |
| Fiyat (₺)  | 127,27                    |



CE

|            |                                |
|------------|--------------------------------|
| Ürün Kodu  | 001 170 014001 00 00           |
| Ürün Adı   | Olimpia Topraklı Erkek Fiş Ups |
| Kutu Adedi | 50                             |
| Fiyat (₺)  | 131,82                         |



|            |                              |
|------------|------------------------------|
| Ürün Kodu  | 001 888 000001 00 00         |
| Ürün Adı   | Prizmatik Priz Koruma Kapağı |
| Kutu Adedi | 100                          |
| Fiyat (₺)  | 39,19                        |



CE

|            |   |
|------------|---|
| Ürün Kodu  | 001 170 033006 00 00                            |
| Ürün Adı   | Olimpia ikili Topraklı Fiş-Priz (Düz Tip Beyaz) |
| Kutu Adedi | 30  |
| Fiyat (₺)  | 256,53  |



CE

|            |   |
|------------|---|
| Ürün Kodu  | 001 170 033007 00 00                                      |
| Ürün Adı   | Olimpia ikili Topraklı Fiş-Priz (Düz Tip Beyaz Anahtarlı) |
| Kutu Adedi | 28  |
| Fiyat (₺)  | 438,49  |



CE

|            |   |
|------------|---|
| Ürün Kodu  | 001 170 033006 00 11                            |
| Ürün Adı   | Olimpia ikili Topraklı Fiş-Priz (Düz Tip Siyah) |
| Kutu Adedi | 30  |
| Fiyat (₺)  | 256,53  |



CE

|            |   |
|------------|---|
| Ürün Kodu  | 001 170 033007 00 11                                      |
| Ürün Adı   | Olimpia ikili Topraklı Fiş-Priz (Düz Tip Siyah Anahtarlı) |
| Kutu Adedi | 28  |
| Fiyat (₺)  | 438,49  |

## Plus Fiş Priz Aksesuarları



CE

|            |                         |
|------------|-------------------------|
| Ürün Kodu  | 001 170 051001 00 00    |
| Ürün Adı   | Plus Topraklı Erkek Fiş |
| Kutu Adedi | 100                     |
| Fiyat (₺)  | 122,73                  |



CE

|            |                        |
|------------|------------------------|
| Ürün Kodu  | 001 170 061001 00 00   |
| Ürün Adı   | Plus Topraklı Dişi Fiş |
| Kutu Adedi | 50                     |
| Fiyat (₺)  | 131,82                 |



|            |                      |
|------------|----------------------|
| Ürün Kodu  | 001 170 050001 00 00 |
| Ürün Adı   | Plus Erkek Fiş       |
| Kutu Adedi | 100                  |
| Fiyat (₺)  | 86,36                |



CE

|            |                      |
|------------|----------------------|
| Ürün Kodu  | 001 170 060001 00 00 |
| Ürün Adı   | Plus Dişi Fiş        |
| Kutu Adedi | 100                  |
| Fiyat (₺)  | 69,32                |



CE

|            |                                |
|------------|--------------------------------|
| Ürün Kodu  | 001 170 011002 00 00           |
| Ürün Adı   | Plus Kulplu Topraklı Erkek Fiş |
| Kutu Adedi | 100                            |
| Fiyat (₺)  | 118,16                         |



|            |                                      |
|------------|--------------------------------------|
| Ürün Kodu  | 001 170 030002 00 00                 |
| Ürün Adı   | Plus Adaptör Fiş, Priz (İngiliz Tip) |
| Kutu Adedi | 100                                  |
| Fiyat (₺)  | 115,88                               |



CE

|            |   |
|------------|---|
| Ürün Kodu  | 001 170 033001 00 00                          |
| Ürün Adı   | Plus Topraklı Üçlü Fiş-Priz (Yonca Tip) (S/A) |
| Kutu Adedi | 20  |
| Fiyat (₺)  | 412,24  |



CE

|            |   |
|------------|---|
| Ürün Kodu  | 001 170 033002 00 00                          |
| Ürün Adı   | Plus Topraklı Üçlü Fiş-Priz (Yonca Tip) (S/Ü) |
| Kutu Adedi | 40  |
| Fiyat (₺)  | 402,76  |



CE

|            |  |
|------------|--|
| Ürün Kodu  | 001 170 033003 00 00                   |
| Ürün Adı   | Plus İkili Topraklı Fiş-Priz (Düz Tip) |
| Kutu Adedi | 50                                     |
| Fiyat (₺)  | 406,58                                 |



CE

|            |                                       |
|------------|---------------------------------------|
| Ürün Kodu  | 001 170 033005 00 00                  |
| Ürün Adı   | Plus Üçlü Topraklı Fiş-Priz (Düz Tip) |
| Kutu Adedi | 40                                    |
| Fiyat (₺)  | 476,14                                |



CE

|            |                      |
|------------|----------------------|
| Ürün Kodu  | 001 170 030001 00 00 |
| Ürün Adı   | Plus Arapuar Anahtar |
| Kutu Adedi | 50/600               |
| Fiyat (₺)  | 74,57                |



CE

|            |   |
|------------|---|
| Ürün Kodu  | 001 170 033004 00 00                              |
| Ürün Adı   | Plus Üçlü Topraklı Fiş-Priz (Düz Tip - Anahtarlı) |
| Kutu Adedi | 30  |
| Fiyat (₺)  | 640,50  |

**Plus** Fiş Priz Aksesuarları

CE

|            |                                      |
|------------|--------------------------------------|
| Ürün Kodu  | 001 170 011002 00 11                 |
| Ürün Adı   | Plus Kulplu Topraklı Erkek Fiş Siyah |
| Kutu Adedi | 100                                  |
| Fiyat (₺)  | 118,16                               |



CE

|            |                      |
|------------|----------------------|
| Ürün Kodu  | 001 170 050001 00 11 |
| Ürün Adı   | Plus Erkek Fiş Siyah |
| Kutu Adedi | 100                  |
| Fiyat (₺)  | 80,06                |



CE

|            |                               |
|------------|-------------------------------|
| Ürün Kodu  | 001 170 051001 00 11          |
| Ürün Adı   | Plus Topraklı Erkek Fiş Siyah |
| Kutu Adedi | 100                           |
| Fiyat (₺)  | 117,17                        |



CE

|            |                      |
|------------|----------------------|
| Ürün Kodu  | 001 170 060001 00 11 |
| Ürün Adı   | Plus Dişi Fiş Siyah  |
| Kutu Adedi | 100                  |
| Fiyat (₺)  | 60,86                |



CE

|            |                              |
|------------|------------------------------|
| Ürün Kodu  | 001 170 061001 00 11         |
| Ürün Adı   | Plus Topraklı Dişi Fiş Siyah |
| Kutu Adedi | 50                           |
| Fiyat (₺)  | 131,46                       |



CE

|            |                            |
|------------|----------------------------|
| Ürün Kodu  | 001 170 030001 00 11       |
| Ürün Adı   | Plus Arapuar Anahtar Siyah |
| Kutu Adedi | 50/600                     |
| Fiyat (₺)  | 74,57                      |



CE

|            |   |
|------------|---|
| Ürün Kodu  | 001 170 033002 00 11                                |
| Ürün Adı   | Plus Topraklı Üçlü Fiş-Priz (Yonca Tip) (S/Ü) Siyah |
| Kutu Adedi | 40  |
| Fiyat (₺)  | 402,76  |



CE

|            |  |
|------------|--|
| Ürün Kodu  | 001 170 033003 00 11                       |
| Ürün Adı   | Plus İkili Topraklı Fiş-Priz Düz Tip Siyah |
| Kutu Adedi | 50   |
| Fiyat (₺)  | 406,58                                     |



CE

|            |   |
|------------|---|
| Ürün Kodu  | 001 170 033005 00 11                        |
| Ürün Adı   | Plus Üçlü Topraklı Fiş-Priz (Düz Tip) Siyah |
| Kutu Adedi | 40  |
| Fiyat (₺)  | 476,14                                      |



CE

|            |   |
|------------|---|
| Ürün Kodu  | 001 170 033004 00 11                                  |
| Ürün Adı   | Plus Üçlü Topraklı Anahtarlı Fiş-Priz (Düz Tip) Siyah |
| Kutu Adedi | 30  |
| Fiyat (₺)  | 640,50  |







CE

|            |  |
|------------|--|
| Ürün Kodu  | 001 170 030002 00 11                       |
| Ürün Adı   | Plus Adaptör Fiş, Priz (İngiliz Tip) Siyah |
| Kutu Adedi | 100  |
| Fiyat (₺)  | 115,88                                     |



**LED**  
için özel  
13 mm x 12,5 mm



| Ürün Kodu   | Ürün Adı   | Amb. (Kutu) | Amb. Birimi | Fiyat (₺) |
|---|--|-------------|-------------|-----------|
| <b>LED İÇİN KENDİNDEN KAPAKLI KABLO KANALI</b> <span style="float: right;">IP40 </span>                          |  |             |             |           |
| 001 004 013012 20 44  | 13x12,5 mm KABLO KANALI ŞEFFAF KANAL (LED İÇİN)                                | 300         | m           | 96,30     |
| <b>CANALEX SERİSİ TSE'Lİ KAPALI TİP KABLO KANALLARI (KUTULU)</b> <span style="float: right;">TSE CE IP40 </span> |  |             |             |           |
| 001 156 012012 20 00  | 12x12 mm KABLO KANALI (CANALEX)  | 250         | m           | 22,04     |
| 001 156 015010 20 00  | 15x10 mm KABLO KANALI (CANALEX)  | 250         | m           | 22,53     |
| 001 156 016016 20 00  | 16x16 mm KABLO KANALI (CANALEX)  | 250         | m           | 24,05     |
| 001 156 020010 20 00  | 20x10 mm KABLO KANALI (CANALEX)  | 200         | m           | 25,96     |
| 001 156 020015 20 00  | 20x15 mm KABLO KANALI (CANALEX)  | 200         | m           | 35,75     |
| 001 156 025016 20 00  | 25x16 mm KABLO KANALI (CANALEX)  | 150         | m           | 36,73     |
| 001 156 025025 20 00  | 25x25 mm KABLO KANALI (CANALEX)  | 100         | m           | 53,87     |
| 001 156 040016 20 00  | 40x16 mm KABLO KANALI (CANALEX)  | 100         | m           | 65,13     |
| 001 156 040025 20 00  | 40x25 mm KABLO KANALI (CANALEX)  | 80          | m           | 71,00     |
| 001 156 040040 20 00  | 40x40 mm KABLO KANALI (CANALEX)  | 50          | m           | 91,10     |
| 001 156 060040 20 00  | 60x40 mm KABLO KANALI (CANALEX)  | 40          | m           | 137,11    |
| 001 156 060060 20 00  | 60x60 mm KABLO KANALI (CANALEX)  | 32          | m           | 210,58    |
| 001 156 080040 20 00  | 80x40 mm KABLO KANALI (CANALEX)  | 30          | m           | 211,81    |
| 001 156 080060 20 00  | 80x60 mm KABLO KANALI (CANALEX)  | 24          | m           | 249,75    |
| 001 156 100040 20 00  | 100x40 mm KABLO KANALI (CANALEX)   | 24          | m           | 259,55    |
| 001 156 100060 20 00  | 100x60 mm KABLO KANALI (CANALEX)   | 20          | m           | 342,80    |
| <b>CANALEX SERİSİ KAPALI TİP KABLO KANALLARI (YAPIŞKAN BANTLI)</b> <span style="float: right;"></span>           |  |             |             |           |
| 001 157 012012 20 00  | 12x12 mm KABLO KANALI CANALEX (YAPIŞKAN BANTLI)                                | 250         | m           | 26,70     |
| 001 157 015010 20 00  | 15x10 mm KABLO KANALI CANALEX (YAPIŞKAN BANTLI)                                | 230         | m           | 27,29     |
| 001 157 016016 20 00  | 16x16 mm KABLO KANALI CANALEX (YAPIŞKAN BANTLI)                                | 240         | m           | 29,13     |
| 001 157 020010 20 00  | 20x10 mm KABLO KANALI CANALEX (YAPIŞKAN BANTLI)                                | 180         | m           | 31,46     |
| 001 157 020015 20 00  | 20x15 mm KABLO KANALI CANALEX (YAPIŞKAN BANTLI)                                | 180         | m           | 43,31     |
| 001 157 025016 20 00  | 25x16 mm KABLO KANALI CANALEX (YAPIŞKAN BANTLI)                                | 150         | m           | 44,50     |
| 001 157 025025 20 00  | 25x25 mm KABLO KANALI CANALEX (YAPIŞKAN BANTLI)                                | 100         | m           | 65,28     |
| 001 157 040016 20 00  | 40x16 mm KABLO KANALI CANALEX (YAPIŞKAN BANTLI)                                | 100         | m           | 78,92     |
| 001 157 040025 20 00  | 40x25 mm KABLO KANALI CANALEX (YAPIŞKAN BANTLI)                                | 80          | m           | 86,04     |
| 001 157 040040 20 00  | 40x40 mm KABLO KANALI CANALEX (YAPIŞKAN BANTLI)                                | 50          | m           | 110,39    |
| 001 157 060040 20 00  | 60x40 mm KABLO KANALI CANALEX (YAPIŞKAN BANTLI)                                | 40          | m           | 166,15    |
| <b>EKO SERİSİ TSE'Lİ KAPALI TİP KABLO KANALLARI</b> <span style="float: right;">TSE CE IP40 </span>            |  |             |             |           |
| 001 014 010008 20 00  | 10x08 mm KABLO KANALI EKO  | 330         | m           | 24,73     |
| 001 014 012012 20 00  | 12x12 mm KABLO KANALI EKO  | 250         | m           | 24,97     |
| 001 014 015010 20 00  | 15x10 mm KABLO KANALI EKO  | 250         | m           | 25,30     |
| 001 014 015015 20 00  | 15x15 mm KABLO KANALI EKO  | 250         | m           | 37,09     |
| 001 014 016016 20 00  | 16x16 mm KABLO KANALI EKO  | 250         | m           | 34,62     |
| 001 014 020010 20 00  | 20x10 mm KABLO KANALI EKO  | 200         | m           | 29,49     |
| 001 014 025016 20 00  | 25x16 mm KABLO KANALI EKO  | 150         | m           | 44,33     |
| 001 014 025025 20 00  | 25x25 mm KABLO KANALI EKO  | 100         | m           | 58,47     |
| 001 014 025040 20 00  | 25x40 mm KABLO KANALI EKO  | 80          | m           | 132,20    |
| 001 014 930010 20 00  | 30x10 mm KABLO KANALI EKO (BÖLMELİ)  | 140         | m           | 65,40     |
| 001 014 030015 20 00  | 30x15 mm KABLO KANALI EKO  | 140         | m           | 59,50     |
| 001 014 930016 20 00  | 30x16 mm KABLO KANALI EKO (BÖLMELİ)  | 140         | m           | 83,32     |
| 001 014 030016 20 00  | 30x16 mm KABLO KANALI EKO  | 140         | m           | 69,42     |
| 001 014 030025 20 00  | 30x25 mm KABLO KANALI EKO  | 80          | m           | 97,82     |
| 001 014 030030 20 00  | 30x30 mm KABLO KANALI EKO  | 80          | m           | 88,64     |
| 001 014 940016 20 00  | 40x16 mm KABLO KANALI EKO (BÖLMELİ)  | 100         | m           | 97,13     |
| 001 014 040016 20 00  | 40x16 mm KABLO KANALI EKO  | 100         | m           | 71,15     |
| 001 014 040025 20 00  | 40x25 mm KABLO KANALI EKO  | 80          | m           | 87,84     |
| 001 014 040040 20 00  | 40x40 mm KABLO KANALI EKO  | 50          | m           | 99,99     |
| 001 014 040060 20 00  | 40x60 mm KABLO KANALI EKO  | 40          | m           | 259,69    |
| 001 014 960025 20 00  | 60x25 mm KABLO KANALI EKO (BÖLMELİ)  | 40          | m           | 177,41    |
| 001 014 060040 20 00  | 60x40 mm KABLO KANALI EKO  | 40          | m           | 159,43    |
| 001 014 050050 20 00  | 50x50 mm KABLO KANALI EKO  | 30          | m           | 226,66    |
| 001 014 060060 20 00  | 60x60 mm KABLO KANALI EKO  | 32          | m           | 216,50    |
| 001 014 075075 20 00  | 75x75 mm KABLO KANALI EKO  | 28          | m           | 360,79    |
| 001 014 080040 20 00  | 80x40 mm KABLO KANALI EKO  | 30          | m           | 277,50    |
| 001 014 080060 20 00  | 80x60 mm KABLO KANALI EKO  | 24          | m           | 269,92    |
| 001 014 100040 20 00  | 100x40 mm KABLO KANALI EKO (PRİZ SETİ TAKILABİLİR)                             | 24          | m           | 275,58    |
| 001 014 100037 20 00  | 100x37 mm KABLO KANALI İÇTEN KAPAKLI KANAL EKO FOLYOLU (PRİZ SETİ TAKILABİLİR) | 30          | m           | 306,60    |
| 001 014 100050 20 00  | 100x50 mm KABLO KANALI İÇTEN KAPAKLI KANAL EKO FOLYOLU (PRİZ SETİ TAKILABİLİR) | 20          | m           | 321,43    |
| 001 014 100060 20 00  | 100x60 mm KABLO KANALI EKO (PRİZ SETİ TAKILABİLİR)                             | 20          | m           | 370,89    |
| 001 014 120060 20 00  | 120x60 mm KABLO KANALI EKO   | 16          | m           | 543,97    |
| 001 014 100100 20 00  | 100x100 mm KABLO KANALI EKO  | 20          | m           | 642,86    |



| Ürün Kodu  | Ürün Adı  | Amb. (Kutu) | Amb. Birimi | Fiyat (₺) |
|--|---|-------------|-------------|-----------|
| <b>EKO SERİSİ KAPALI TİP KABLO KANALLARI (YAPIŞKAN BANTLI)</b>                           |   |             |             |           |
| IP40  |   |             |             |           |
| 001 004 009005 20 00   | 9x5 mm KABLO KANALI KENDİNDEN KAPAKLI                         | 500         | m           | 41,09     |
| 001 004 010007 20 44   | 9,5x7 mm KABLO KANALI ŞEFFAF KANAL                            | 500         | m           | 62,21     |
| 001 004 012007 20 00   | 12x7,5 mm KABLO KANALI KENDİNDEN KAPAKLI                      | 350         | m           | 42,17     |
| 001 004 013012 20 00   | 13x12,5 mm KABLO KANALI KENDİNDEN KAPAKLI                     | 300         | m           | 51,10     |
| 001 004 010008 20 00   | 10x8 mm KABLO KANALI EKO (YAPIŞKAN BANTLI)                    | 330         | m           | 28,20     |
| 001 004 010010 20 00   | 10x10 mm KABLO KANALI EKO KENDİNDEN KAPAKLI (YAPIŞKAN BANTLI) | 320         | m           | 43,25     |
| 001 004 012012 20 00   | 12x12 mm KABLO KANALI EKO (YAPIŞKAN BANTLI)                   | 250         | m           | 34,39     |
| 001 004 015010 20 00   | 15x10 mm KABLO KANALI EKO (YAPIŞKAN BANTLI)                   | 230         | m           | 35,37     |
| 001 004 016016 20 00   | 16x16 mm KABLO KANALI EKO (YAPIŞKAN BANTLI)                   | 240         | m           | 41,56     |
| 001 004 020010 20 00   | 20x10 mm KABLO KANALI EKO (YAPIŞKAN BANTLI)                   | 180         | m           | 39,29     |
| 001 004 025016 20 00   | 25x16 mm KABLO KANALI EKO (YAPIŞKAN BANTLI)                   | 150         | m           | 59,93     |
| 001 004 025025 20 00   | 25x25 mm KABLO KANALI EKO (YAPIŞKAN BANTLI)                   | 100         | m           | 78,59     |
| 001 004 025040 20 00   | 25x40 mm KABLO KANALI EKO (YAPIŞKAN BANTLI)                   | 80          | m           | 152,25    |
| 001 004 930010 20 00   | 30x10 mm KABLO KANALI EKO (YAPIŞKAN BANTLI) (BÖLMELİ)         | 140         | m           | 74,65     |
| 001 004 030016 20 00   | 30x16 mm KABLO KANALI EKO (YAPIŞKAN BANTLI)                   | 140         | m           | 78,59     |
| 001 004 030025 20 00   | 30x25 mm KABLO KANALI EKO (YAPIŞKAN BANTLI)                   | 80          | m           | 110,50    |
| 001 004 040016 20 00   | 40x16 mm KABLO KANALI EKO (YAPIŞKAN BANTLI)                   | 100         | m           | 88,41     |
| 001 004 040025 20 00   | 40x25 mm KABLO KANALI EKO (YAPIŞKAN BANTLI)                   | 80          | m           | 112,43    |
| 001 004 040040 20 00   | 40x40 mm KABLO KANALI EKO (YAPIŞKAN BANTLI)                   | 50          | m           | 131,06    |
| 001 004 060040 20 00   | 60x40 mm KABLO KANALI EKO (YAPIŞKAN BANTLI)                   | 40          | m           | 206,29    |





| Ürün Kodu   | Ürün Adı  | Amb. (Kutu) | Amb. Birimi | Fiyat (₺) |
|---|---|-------------|-------------|-----------|
| <b>MEKS SERİSİ TSE'Lİ KAPALI TİP KABLO KANALLARI</b>  |   |             |             |           |
| TSE CE IP40  |   |             |             |           |
| 001 002 015015 20 00  | 15x15 mm KABLO KANALI MEKS                            | 250         | m           | 44,86     |
| 001 002 016016 20 00  | 16x16 mm KABLO KANALI MEKS                            | 250         | m           | 45,37     |
| 001 002 025016 20 00  | 25x16 mm KABLO KANALI MEKS                            | 150         | m           | 65,54     |
| 001 002 025025 20 00  | 25x25 mm KABLO KANALI MEKS                            | 100         | m           | 85,70     |
| 001 002 030015 20 00  | 30x15 mm KABLO KANALI MEKS                            | 140         | m           | 78,14     |
| 001 002 030030 20 00  | 30x30 mm KABLO KANALI MEKS                            | 80          | m           | 110,90    |
| 001 002 040017 20 00  | 40x17 mm KABLO KANALI TAM KAPAKLI MEKS                | 100         | m           | 124,53    |
| 001 002 940017 20 00  | 40x17 mm KABLO KANALI TAM KAPAKLI MEKS (BÖLMELİ)      | 100         | m           | 133,04    |
| 001 002 040025 20 00  | 40x25 mm KABLO KANALI MEKS                            | 80          | m           | 124,68    |
| 001 002 040040 20 00  | 40x40 mm KABLO KANALI MEKS                            | 50          | m           | 145,00    |
| 001 002 960025 20 00  | 60x25 mm KABLO KANALI MEKS (BÖLMELİ)                  | 40          | m           | 216,77    |
| 001 002 060040 20 00  | 60x40 mm KABLO KANALI MEKS                            | 40          | m           | 226,86    |
| 001 002 080060 20 00  | 80x60 mm KABLO KANALI MEKS                            | 24          | m           | 362,97    |
| 001 002 100040 20 00  | 100x40 mm KABLO KANALI MEKS (PRİZ SETİ TAKILABİLİR)   | 24          | m           | 388,18    |
| 001 002 100048 20 00  | 100x48 mm KABLO KANALI MEKS (PRİZ SETİ TAKILABİLİR)   | 24          | m           | 504,11    |
| 001 002 100060 20 00  | 100x60 mm KABLO KANALI MEKS (PRİZ SETİ TAKILABİLİR)   | 20          | m           | 514,20    |
| 001 002 120060 20 00  | 120x60 mm KABLO KANALI MEKS                           | 16          | m           | 705,76    |
| <b>MEKS SERİSİ İÇTEN KAPAKLI KAPALI TİP KABLO KANALLARI</b>                                       |   |             |             |           |
| TSE CE IP40  |   |             |             |           |
| 001 002 100037 20 00  | 100x37 mm KABLO KANALI MEKS (İÇTEN KAPAKLI)(FOLYOLU)  | 30          | m           | 428,49    |
| 001 002 100041 20 00  | 100x41 mm KABLO KANALI MEKS (İÇTEN KAPAKLI)(FOLYOLU)  | 24          | m           | 433,54    |
| 001 002 100050 20 00  | 100x50 mm KABLO KANALI MEKS (İÇTEN KAPAKLI)(FOLYOLU)  | 20          | m           | 453,70    |
| 001 002 120070 20 00  | 120x70 mm KABLO KANALI (İÇTEN KAPAKLI)(AKSESUAR SIZ)  | 16          | m           | 705,76    |
| 001 002 170070 20 00  | 170x70 mm KABLO KANALI (İÇTEN KAPAKLI)(AKSESUAR SIZ)  | 12          | m           | 841,87    |
| 001 002 250070 20 00  | 250x70 mm KABLO KANALI (İÇTEN KAPAKLI)(AKSESUAR SIZ)  | 8           | m           | 1.310,70  |
| <b>MEKSPLUS SERİSİ KAPALI TİP KABLO KANALLARI</b>   |   |             |             |           |
| TSE CE IP40  |   |             |             |           |
| 001 003 100037 20 00  | 100x37 mm KABLO KANALI (İÇTEN KAPAKLI)                | 30          | m           | 453,70    |
| 001 003 100041 20 00  | 100x41 mm KABLO KANALI (İÇTEN KAPAKLI)                | 24          | m           | 463,79    |
| 001 003 100050 20 00  | 100x50 mm KABLO KANALI (İÇTEN KAP.)(ET KALINLIĞI 2mm) | 20          | m           | 504,11    |
| 001 006 100050 20 00  | 100x50 mm KABLO KANALI (İÇTEN KAPAKLI)(KAİDESİZ SERİ) | 20          | m           | 626,21    |
| 001 003 120070 20 00  | 120x70 mm KABLO KANALI (İÇTEN KAPAKLI)(AKSESUAR SIZ)  | 16          | m           | 806,58    |
| 001 003 170050 20 00  | 170x50 mm KABLO KANALI (İÇTEN KAPAKLI)                | 12          | m           | 1.008,23  |
| 001 003 170070 20 00  | 170x70 mm KABLO KANALI (İÇTEN KAPAKLI)(AKSESUAR SIZ)  | 12          | m           | 1.235,09  |
| 001 003 250070 20 00  | 250x70 mm KABLO KANALI (İÇTEN KAPAKLI)(AKSESUAR SIZ)  | 8           | m           | 1.436,73  |





| Ürün Kodu   | Ürün Adı                    | Amb. (Kutu) | Amb. Birimi | Fiyat (₺) |
|---|-----------------------------|-------------|-------------|-----------|
| <b>MEKS SERİSİ KLİMA KANALI ve AKSESUARLARI</b>   |                             |             |             |           |
| 001 002 075060 20 00  | 75x60 mm KLİMA KANALI       | 30          | m           | 302,47    |
| 001 050 030002 00 00  | KLİMA KANALI KABLO TUTUCUSU | 60          | ad.         | 51,49     |
| 001 043 075060 00 00  | KLİMA KANALI EK PARÇASI     | 40          | ad.         | 51,49     |
| 001 039 075060 00 00  | KLİMA KANALI İÇ KÖŞE        | 24          | ad.         | 101,86    |
| 001 040 075060 00 00  | KLİMA KANALI DIŞ KÖŞE       | 24          | ad.         | 101,86    |
| 001 042 075060 00 00  | KLİMA KANALI L KÖŞE         | 18          | ad.         | 101,86    |
| 001 050 030001 00 00  | KLİMA KANALI DUVAR GEÇİŞİ   | 60          | ad.         | 63,67     |
| 001 044 075060 01 00  | KLİMA KANALI İÇ SONLAMA     | 30          | ad.         | 101,86    |
| 001 044 075060 02 00  | KLİMA KANALI DIŞ SONLAMA    | 18          | ad.         | 101,86    |



| Ürün Kodu  | Ürün Adı                   | Amb. (Kutu) | Amb. Birimi | Fiyat (₺) |
|--|----------------------------|-------------|-------------|-----------|
| <b>TAVAN KÖŞE KANALI (23x23) ve AKSESUARLARI</b>   |                            |             |             |           |
| 001 002 023023 20 00   | 23x23 mm TAVAN KÖŞE KANALI | 120         | m           | 122,66    |
| 001 041 023023 00 00   | 23x23 mm T PARÇASI         | 60          | ad.         | 29,67     |
| 001 042 023023 00 00   | 23x23 mm 90 L KÖŞE         | 60          | ad.         | 29,67     |
| 001 043 023023 00 00   | 23x23 mm EK PARÇA          | 100         | ad.         | 23,74     |
| 001 044 023023 00 00   | 23x23 mm UÇ TAPA           | 100         | ad.         | 23,74     |



| Ürün Kodu   | Ürün Adı                              | Amb. (Kutu) | Amb. Birimi | Fiyat (₺) |
|---|---------------------------------------|-------------|-------------|-----------|
| <b>SÜPÜRGELİK KABLO KANALLARI ve AKSESUARLARI</b> |                                       |             |             |           |
| 001 010 000200 20 00                              | 50'LİK FUGALI SÜPÜRGELİK              | 60          | m           | 126,39    |
| 001 014 974020 20 00                              | 74x20 mm KABLO KANALI EKO (BÖLMELİ)   | 50          | m           | 241,01    |
| 001 039 074020 00 00                              | 74x20 İÇ KÖŞE                         | 20          | ad.         | 75,62     |
| 001 040 074020 00 00                              | 74x20 DIŞ KÖŞE                        | 20          | ad.         | 75,62     |
| 001 041 074020 00 00                              | 74x20 T KÖŞE                          | 30          | ad.         | 88,21     |
| 001 042 074020 01 00                              | 74x90 20 L KÖŞE                       | 40          | ad.         | 88,21     |
| 001 043 074020 00 00                              | 74x20 EK PARÇA                        | 50          | ad.         | 42,91     |
| 001 044 074020 00 00                              | 74x20 UÇ TAPA                         | 50          | ad.         | 42,91     |
| 001 047 017420 00 00                              | 74x20 PRİZ MONTAJ KASASI (55x55)      | 6           | ad.         | 259,26    |
| 001 047 017421 00 00                              | 74x20 1'Lİ PRİZ MONTAJ KASASI (45x45) | 12          | ad.         | 429,63    |
| 001 002 975022 20 00                              | 75x22 mm KABLO KANALI (BÖLMELİ)       | 50          | m           | 333,33    |
| 001 039 075022 00 00                              | 75x22 mm İÇ KÖŞE                      | 20          | ad.         | 43,21     |
| 001 040 075022 00 00                              | 75x22 mm DIŞ KÖŞE                     | 20          | ad.         | 43,21     |
| 001 044 075022 01 00                              | 75x22 mm SAĞ SONLAMA                  | 30          | ad.         | 66,27     |
| 001 044 075022 02 00                              | 75x22 mm SOL SONLAMA                  | 20          | ad.         | 65,15     |
| 001 043 075022 00 00                              | 75x22 mm EK PARÇASI                   | 100         | ad.         | 50,00     |



| Ürün Kodu   | Ürün Adı                        | Amb. (Kutu) | Amb. Birimi | Fiyat (₺) |
|---|---------------------------------|-------------|-------------|-----------|
| <b>TEZGAH SÜPÜRGELİĞİ</b>  |                                 |             |             |           |
| 001 011 000100 00 00  | 25'LİK TEZGAH SÜPÜRGELİĞİ 100CM | 60          | m           | 137,04    |



| Ürün Kodu  | Ürün Adı  | Amb. (Kutu) | Amb. Birimi | Fiyat (₺) |
|--|---|-------------|-------------|-----------|
| <b>BALIK SIRTI KANALLARI</b>  |   |             |             |           |
| 001 002 050013 20 17   | 50x13 mm BALIK SIRTI KANAL (ZEMİN İÇİN)             | 60          | m           | 148,15    |
| 001 002 060015 20 17   | 60x15 mm BALIK SIRTI KANAL (ZEMİN İÇİN)             | 40          | m           | 166,67    |
| 001 002 075018 20 17   | 75x18 mm BALIK SIRTI KANAL (ZEMİN İÇİN)             | 30          | m           | 277,78    |
| 001 002 090020 20 17   | 90x20 mm BALIK SIRTI KANAL (ZEMİN İÇİN)             | 20          | m           | 351,85    |
| 001 004 050013 20 17   | 50x13 mm KABLO KANALI BALIK SIRTI (YAPIŞKAN BANTLI) | 60          | m           | 166,67    |
| 001 004 060015 20 17   | 60x15 mm KABLO KANALI BALIK SIRTI (YAPIŞKAN BANTLI) | 40          | m           | 185,19    |
| 001 004 075018 20 17   | 75x18 mm KABLO KANALI BALIK SIRTI (YAPIŞKAN BANTLI) | 30          | m           | 303,70    |
| 001 004 090020 20 17   | 90x20 mm KABLO KANALI BALIK SIRTI (YAPIŞKAN BANTLI) | 20          | m           | 374,07    |

# flaret®

HF HALOJEN FREE Flame Retardant Alev Yayımayan



DIŞ KÖŞE



T KÖŞE



L KÖŞE



İÇ KÖŞE









UÇ TAPA











EK PARÇA





| Ürün Kodu   | Ürün Adı  | Amb. (Kutu) | Amb. Birimi | Fiyat (₺) |
|---|---|-------------|-------------|-----------|
| <b>H.FREE FLARET SERİSİ KAPALI TİP KABLO KANALLARI</b>   IP40   |   |             |             |           |
| 001 060 100050 20 00  | 100x50 mm KABLO KANALI İÇTEN KAPAKLI HALOJEN FREE         | 20          | m           | 1.481,48  |
| 001 061 100050 20 00  | 100x50 mm KABLO KANALI ARA BÖLME HALOJEN FREE             | 150         | m           | 170,37    |
| 001 039 100050 11 00  | 100x50-37 mm KABLO KANALI İÇ KÖŞE(HAREKETLİ) HALOJEN FREE | 12          | ad.         | 151,85    |
| 001 040 100050 11 00  | 100x50 mm KABLO KANALI DIŞ KÖŞE (HAREKETLİ) HALOJEN FREE  | 10          | ad.         | 151,85    |
| 001 041 100050 11 00  | 100x50 mm KABLO KANALI T PARÇASI HALOJEN FREE             | 10          | ad.         | 170,37    |
| 001 042 100050 11 00  | 100x50 mm KABLO KANALI 90 L KÖŞE HALOJEN FREE             | 10          | ad.         | 170,37    |
| 001 043 100050 11 00  | 100x50 mm KABLO KANALI EK PARÇA (ÜÇLÜ SET) HALOJEN FREE   | 100         | ad.         | 70,37     |
| 001 044 100050 11 00  | 100x50 mm KABLO KANALI UÇ TAPA HALOJEN FREE               | 40          | ad.         | 70,37     |
| 001 047 100001 11 00  | PMS(100x37/50)(45X45)(1'Lİ) HALOJEN FREE                  | 30          | ad.         | 129,63    |
| 001 047 100002 11 00  | PMS(100x37/50)(45X45)(2'Lİ) HALOJEN FREE                  | 16          | ad.         | 166,67    |
| 001 047 100003 11 00  | PMS(100x37/50)(45X45)(3'LÜ) HALOJEN FREE                  | 14          | ad.         | 222,22    |

|   |                                    |     |   |        |
|---|------------------------------------|-----|---|--------|
| <b>H.FREE FLARET SERİSİ KAPALI TİP KABLO KANALLARI</b>   IP40   |                                    |     |   |        |
| 001 060 025016 20 00  | 25x16 mm KABLO KANALI HALOJEN FREE | 150 | m | 277,78 |
| 001 060 025025 20 00  | 25x25 mm KABLO KANALI HALOJEN FREE | 100 | m | 314,81 |
| 001 060 040025 20 00  | 40x25 mm KABLO KANALI HALOJEN FREE | 80  | m | 462,96 |
| 001 060 040040 20 00  | 40x40 mm KABLO KANALI HALOJEN FREE | 50  | m | 537,04 |

|  |                    |     |     |       |
|--|--------------------|-----|-----|-------|
| <b>25x16 H.FREE FLARET KANAL AKSESUARLARI</b>   IP40   |                    |     |     |       |
| 001 039 025016 11 00   | 25x16 mm İÇ KÖŞE   | 40  | ad. | 35,19 |
| 001 040 025016 11 00   | 25x16 mm DIŞ KÖŞE  | 40  | ad. | 35,19 |
| 001 041 025016 11 00   | 25x16 mm T PARÇASI | 30  | ad. | 55,56 |
| 001 042 025016 11 00   | 25x16 mm 90 L KÖŞE | 80  | ad. | 55,56 |
| 001 043 025016 11 00   | 25x16 mm EK PARÇA  | 100 | ad. | 33,33 |
| 001 044 025016 11 00   | 25x16 mm UÇ TAPA   | 100 | ad. | 33,33 |

|  |                    |     |     |       |
|--|--------------------|-----|-----|-------|
| <b>25x25 H.FREE FLARET KANAL AKSESUARLARI</b>   IP40   |                    |     |     |       |
| 001 039 025025 11 00   | 25x25 mm İÇ KÖŞE   | 40  | ad. | 40,74 |
| 001 040 025025 11 00   | 25x25 mm DIŞ KÖŞE  | 40  | ad. | 40,74 |
| 001 041 025025 11 00   | 25x25 mm T PARÇASI | 30  | ad. | 62,96 |
| 001 042 025025 11 00   | 25x25 mm 90 L KÖŞE | 50  | ad. | 62,96 |
| 001 043 025025 11 00   | 25x25 mm EK PARÇA  | 100 | ad. | 37,04 |
| 001 044 025025 11 00   | 25x25 mm UÇ TAPA   | 100 | ad. | 37,04 |

|  |                    |    |     |        |
|--|--------------------|----|-----|--------|
| <b>40x25 H.FREE FLARET KANAL AKSESUARLARI</b>   IP40   |                    |    |     |        |
| 001 039 040025 11 00   | 40x25 mm İÇ KÖŞE   | 24 | ad. | 92,59  |
| 001 040 040025 11 00   | 40x25 mm DIŞ KÖŞE  | 30 | ad. | 92,59  |
| 001 041 040025 11 00   | 40x25 mm T PARÇASI | 18 | ad. | 103,70 |
| 001 042 040025 11 00   | 40x25 mm 90 L KÖŞE | 24 | ad. | 103,70 |
| 001 043 040025 11 00   | 40x25 mm EK PARÇA  | 70 | ad. | 74,07  |
| 001 044 040025 11 00   | 40x25 mm UÇ TAPA   | 25 | ad. | 74,07  |

|  |                    |     |     |        |
|--|--------------------|-----|-----|--------|
| <b>40x40 H.FREE FLARET KANAL AKSESUARLARI</b>   IP40   |                    |     |     |        |
| 001 039 040040 11 00   | 40x40 mm İÇ KÖŞE   | 18  | ad. | 96,30  |
| 001 040 040040 11 00   | 40x40 mm DIŞ KÖŞE  | 16  | ad. | 96,30  |
| 001 041 040040 11 00   | 40x40 mm T PARÇASI | 48  | ad. | 107,41 |
| 001 042 040040 11 00   | 40x40 mm 90 L KÖŞE | 60  | ad. | 107,41 |
| 001 043 040040 11 00   | 40x40 mm EK PARÇA  | 100 | ad. | 77,78  |
| 001 044 040040 11 00   | 40x40 mm UÇ TAPA   | 25  | ad. | 77,78  |



EK PARÇA



T KÖŞE



İÇ KÖŞE



DIŞ KÖŞE



















L KÖŞE



UÇ TAPA



| Ürün Kodu   | Ürün Adı                                  | Amb. (Kutu) | Amb. Birimi | Fiyat (₺) |
|---|---|-------------|-------------|-----------|
| <b>BALIK SIRTI 60x15 AKSESUARLARI</b>                                   |   |             |             |           |
| 001 042 060015 00 17  | 60x15 mm BALIK SIRTI KANAL L KÖŞE         | 24          | ad.         | 66,67     |
| 001 043 060015 00 17  | 60x15 mm BALIK SIRTI KANAL EK PARÇASI     | 50          | ad.         | 31,48     |
| 001 044 060015 00 17  | 60x15 mm BALIK SIRTI KANAL SONLAMA KAPAĞI | 50          | ad.         | 31,48     |
| 001 041 060015 00 17  | 60x15 mm BALIK SIRTI KANAL T KÖŞE         | 10          | ad.         | 66,67     |
| <b>BALIK SIRTI 75x18 AKSESUARLARI</b>                                   |   |             |             |           |
| 001 042 075018 00 17  | 75x18 mm BALIK SIRTI KANAL L KÖŞE         | 15          | ad.         | 81,48     |
| 001 043 075018 00 17  | 75x18 mm BALIK SIRTI KANAL EK PARÇASI     | 50          | ad.         | 37,04     |
| 001 044 075018 00 17  | 75x18 mm BALIK SIRTI KANAL SONLAMA KAPAĞI | 50          | ad.         | 37,04     |
| 001 041 075018 00 17  | 75x18 mm BALIK SIRTI KANAL T KÖŞE         | 8           | ad.         | 81,48     |
| <b>BALIK SIRTI 90x20 AKSESUARLARI</b>                                   |   |             |             |           |
| 001 042 090020 00 17  | 90x20 mm BALIK SIRTI KANAL KANAL L KÖŞE   | 20          | ad.         | 92,59     |
| 001 043 090020 00 17  | 90x20 mm BALIK SIRTI KANAL EK PARÇASI     | 50          | ad.         | 40,74     |
| 001 044 090020 00 17  | 90x20 mm BALIK SIRTI KANAL SONLAMA KAPAĞI | 50          | ad.         | 40,74     |
| 001 041 090020 00 17  | 90x20 mm BALIK SIRTI KANAL T KÖŞE         | 12          | ad.         | 92,59     |
| <b>12X12 KANAL AKSESUARLARI</b> <span style="float: right;">IP40</span> |   |             |             |           |
| 001 039 012012 00 00  | 12x12 mm İÇ KÖŞE                          | 60          | ad.         | 25,93     |
| 001 040 012012 00 00  | 12x12 mm DIŞ KÖŞE                         | 60          | ad.         | 25,93     |
| 001 041 012012 00 00  | 12x12 mm T KÖŞE                           | 60          | ad.         | 27,78     |
| 001 042 012012 00 00  | 12x12 mm 90 L KÖŞE                        | 60          | ad.         | 27,78     |
| 001 044 012012 00 00  | 12x12 mm UÇ TAPA                          | 100         | ad.         | 25,00     |
| 001 043 012012 00 00  | 12x12 mm EK PARÇASI                       | 100         | ad.         | 25,00     |
| <b>15X10 KANAL AKSESUARLARI</b> <span style="float: right;">IP40</span> |   |             |             |           |
| 001 039 015010 00 00  | 15x10 mm İÇ KÖŞE                          | 60          | ad.         | 25,93     |
| 001 040 015010 00 00  | 15x10 mm DIŞ KÖŞE                         | 60          | ad.         | 25,93     |
| 001 041 015010 00 00  | 15x10 mm T KÖŞE                           | 60          | ad.         | 27,78     |
| 001 042 015010 00 00  | 15x10 mm 90 L KÖŞE                        | 60          | ad.         | 27,78     |
| 001 044 015010 00 00  | 15x10 mm UÇ TAPA                          | 100         | ad.         | 25,00     |
| 001 043 015010 00 00  | 15x10 mm EK PARÇASI                       | 100         | ad.         | 25,00     |
| <b>20X10 KANAL AKSESUARLARI</b> <span style="float: right;">IP40</span> |   |             |             |           |
| 001 039 020010 00 00  | 20x10 mm İÇ KÖŞE                          | 60          | ad.         | 25,93     |
| 001 040 020010 00 00  | 20x10 mm DIŞ KÖŞE                         | 60          | ad.         | 25,93     |
| 001 041 020010 00 00  | 20x10 mm T KÖŞE                           | 30          | ad.         | 27,78     |
| 001 042 020010 00 00  | 20x10 mm 90 L KÖŞE                        | 50          | ad.         | 27,78     |
| 001 044 020010 00 00  | 20x10 mm UÇ TAPA                          | 100         | ad.         | 25,00     |
| 001 043 020010 00 00  | 20x10 mm EK PARÇASI                       | 100         | ad.         | 25,00     |
| <b>16X16 KANAL AKSESUARLARI</b> <span style="float: right;">IP40</span> |   |             |             |           |
| 001 039 016016 00 00  | 16x16 mm İÇ KÖŞE                          | 100         | ad.         | 25,93     |
| 001 040 016016 00 00  | 16x16 mm DIŞ KÖŞE                         | 100         | ad.         | 25,93     |
| 001 041 016016 00 00  | 16x16 mm T KÖŞE                           | 60          | ad.         | 31,48     |
| 001 042 016016 00 00  | 16x16 mm 90 L KÖŞE                        | 60          | ad.         | 31,48     |
| 001 044 016016 00 00  | 16x16 mm UÇ TAPA                          | 100         | ad.         | 25,00     |
| 001 043 016016 00 00  | 16x16 mm EK PARÇASI                       | 100         | ad.         | 25,00     |
| <b>25X16 KANAL AKSESUARLARI</b> <span style="float: right;">IP40</span> |   |             |             |           |
| 001 039 025016 00 00  | 25x16 mm İÇ KÖŞE                          | 40          | ad.         | 27,78     |
| 001 040 025016 00 00  | 25x16 mm DIŞ KÖŞE                         | 40          | ad.         | 27,78     |
| 001 041 025016 00 00  | 25x16 mm T KÖŞE                           | 30          | ad.         | 44,44     |
| 001 042 025016 00 00  | 25x16 mm 90 L KÖŞE                        | 80          | ad.         | 44,44     |
| 001 044 025016 00 00  | 25x16 mm UÇ TAPA                          | 100         | ad.         | 27,78     |
| 001 043 025016 00 00  | 25x16 mm EK PARÇASI                       | 100         | ad.         | 27,78     |
| 001 047 017421 00 00  | 25X16 mm PMK (45x45)                      | 12          | ad.         | 429,63    |
| <b>25X25 KANAL AKSESUARLARI</b> <span style="float: right;">IP40</span> |   |             |             |           |
| 001 039 025025 00 00  | 25x25 mm İÇ KÖŞE                          | 40          | ad.         | 35,20     |
| 001 040 025025 00 00  | 25x25 mm DIŞ KÖŞE                         | 40          | ad.         | 35,20     |
| 001 041 025025 00 00  | 25x25 mm T KÖŞE                           | 24          | ad.         | 58,66     |
| 001 042 025025 00 00  | 25x25 mm 90 L KÖŞE                        | 40          | ad.         | 58,66     |
| 001 044 025025 00 00  | 25x25 mm UÇ TAPA                          | 100         | ad.         | 32,78     |
| 001 043 025025 00 00  | 25x25 mm EK PARÇASI                       | 50          | ad.         | 32,78     |
| 001 047 017421 00 00  | 25x25 mm PMK (45x45)                      | 12          | ad.         | 429,63    |

| Ürün Kodu   | Ürün Adı                      | Amb. (Kutu) | Amb. Birimi | Fiyat (₺) |
|---|-------------------------------|-------------|-------------|-----------|
| <b>30X10 KANAL AKSESUARLARI</b>       |                               |             |             |           |
| 001 039 030010 00 00  | 30x10 mm İÇ KÖŞE              | 50          | ad.         | 48,31     |
| 001 040 030010 00 00  | 30x10 mm DIŞ KÖŞE             | 50          | ad.         | 48,31     |
| 001 041 030010 00 00  | 30x10 mm T KÖŞE               | 50          | ad.         | 62,12     |
| 001 042 030010 00 00  | 30x10 mm 90 L KÖŞE            | 50          | ad.         | 62,12     |
| 001 044 030025 00 00  | 30x10-16-25 mm UÇ TAPA        | 100         | ad.         | 51,76     |
| 001 043 030025 00 00  | 30x10-16-25 mm EK PARÇASI     | 100         | ad.         | 51,76     |
| <b>30X16 KANAL AKSESUARLARI</b>       |                               |             |             |           |
| 001 039 030016 00 00  | 30x16 mm İÇ KÖŞE              | 35          | ad.         | 72,22     |
| 001 040 030016 00 00  | 30x16 mm DIŞ KÖŞE             | 48          | ad.         | 72,22     |
| 001 041 030016 00 00  | 30x16 mm T KÖŞE               | 40          | ad.         | 77,78     |
| 001 042 030016 00 00  | 30x16 mm 90 L KÖŞE            | 50          | ad.         | 77,78     |
| 001 044 030025 00 00  | 30x10-16-25 mm UÇ TAPA        | 100         | ad.         | 51,74     |
| 001 043 030025 00 00  | 30x10-16-25 mm EK PARÇASI     | 100         | ad.         | 51,74     |
| <b>30X25 KANAL AKSESUARLARI</b>       |                               |             |             |           |
| 001 039 030025 00 00  | 30x25 mm İÇ KÖŞE              | 30          | ad.         | 72,22     |
| 001 040 030025 00 00  | 30x25 mm DIŞ KÖŞE             | 32          | ad.         | 72,22     |
| 001 041 030025 00 00  | 30x25 mm T KÖŞE               | 24          | ad.         | 77,78     |
| 001 042 030025 00 00  | 30x25 mm 90 L KÖŞE            | 30          | ad.         | 77,78     |
| 001 044 030025 00 00  | 30x10-16-25 mm UÇ TAPA        | 100         | ad.         | 51,74     |
| 001 043 030025 00 00  | 30x10-16-25 mm EK PARÇASI     | 100         | ad.         | 51,74     |
| <b>40X16 KANAL AKSESUARLARI</b>       |                               |             |             |           |
| 001 039 040016 00 00  | 40x16 mm İÇ KÖŞE              | 32          | ad.         | 59,26     |
| 001 040 040016 00 00  | 40x16 mm DIŞ KÖŞE             | 30          | ad.         | 59,26     |
| 001 041 040016 00 00  | 40x16 mm T KÖŞE               | 24          | ad.         | 66,67     |
| 001 042 040016 00 00  | 40x16 mm 90 L KÖŞE            | 34          | ad.         | 66,67     |
| 001 044 040040 00 00  | 40x16-25-40 mm UÇ TAPA        | 25          | ad.         | 51,85     |
| 001 043 040016 00 00  | 40x16-25-40 mm EK PARÇASI     | 100         | ad.         | 51,85     |
| 001 047 017421 00 00  | 40x16 mm PMK (45x45)          | 12          | ad.         | 429,63    |
| <b>40X25 KANAL AKSESUARLARI</b>   |                               |             |             |           |
| 001 039 040025 00 00  | 40x25 mm İÇ KÖŞE              | 24          | ad.         | 62,96     |
| 001 040 040025 00 00  | 40x25 mm DIŞ KÖŞE             | 30          | ad.         | 62,96     |
| 001 041 040025 00 00  | 40x25 mm T KÖŞE               | 18          | ad.         | 70,37     |
| 001 042 040025 00 00  | 40x25 mm 90 L KÖŞE            | 24          | ad.         | 70,37     |
| 001 044 040040 00 00  | 40x16-25-40 mm UÇ TAPA        | 25          | ad.         | 51,85     |
| 001 043 040016 00 00  | 40x16-25-40 mm EK PARÇASI     | 100         | ad.         | 51,85     |
| 001 047 017421 00 00  | 40x25 mm PMK (45x45)          | 12          | ad.         | 429,63    |
| <b>40X40 KANAL AKSESUARLARI</b>   |                               |             |             |           |
| 001 039 040040 01 00  | 40x40 mm İÇ KÖŞE (HAREKETLİ)  | 18          | ad.         | 62,96     |
| 001 040 040040 01 00  | 40x40 mm DIŞ KÖŞE (HAREKETLİ) | 16          | ad.         | 62,96     |
| 001 041 040040 00 00  | 40x40 mm T KÖŞE               | 48          | ad.         | 70,37     |
| 001 042 040040 00 00  | 40x40 mm 90 L KÖŞE            | 60          | ad.         | 70,37     |
| 001 044 040040 00 00  | 40x16-25-40 mm UÇ TAPA        | 50          | ad.         | 51,85     |
| 001 043 040016 00 00  | 40x16-25-40 mm EK PARÇASI     | 100         | ad.         | 51,85     |
| 001 047 017421 00 00  | 40x40 mm PMK (45x45)          | 12          | ad.         | 429,63    |
| <b>60X25 KANAL AKSESUARLARI</b>   |                               |             |             |           |
| 001 039 060025 00 00  | 60x25 mm İÇ KÖŞE              | 48          | ad.         | 68,52     |
| 001 040 060025 00 00  | 60x25 mm DIŞ KÖŞE             | 72          | ad.         | 68,52     |
| 001 041 060025 00 00  | 60x25 mm T KÖŞE               | 40          | ad.         | 81,48     |
| 001 042 060025 00 00  | 60x25 mm 90 L KÖŞE            | 60          | ad.         | 81,48     |
| 001 044 060025 00 00  | 60x25 mm UÇ TAPA              | 50          | ad.         | 51,85     |
| 001 043 060025 00 00  | 60x25 mm EK PARÇASI           | 60          | ad.         | 51,85     |
| <b>60X40 KANAL AKSESUARLARI</b>   |                               |             |             |           |
| 001 039 060040 00 00  | 60x40 mm İÇ KÖŞE              | 26          | ad.         | 85,19     |
| 001 040 060040 00 00  | 60x40 mm DIŞ KÖŞE             | 32          | ad.         | 85,19     |
| 001 041 060040 00 00  | 60x40 mm T KÖŞE               | 32          | ad.         | 88,89     |
| 001 042 060040 00 00  | 60x40 mm 90 L KÖŞE            | 40          | ad.         | 88,89     |
| 001 044 060040 00 00  | 60x40 mm UÇ TAPA              | 50          | ad.         | 51,85     |
| 001 043 060040 00 00  | 60x40 mm EK PARÇASI           | 40          | ad.         | 51,85     |



UÇ TAPA



T KÖŞE



İÇ KÖŞE



EK PARÇA

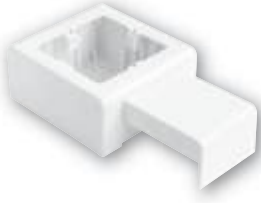

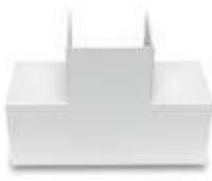
**PRİZ MONTAJ KASASI**

**EK PARÇA**

**T KÖŞE**

| Ürün Kodu   | Ürün Adı                                | Amb. (Kutu) | Amb. Birimi | Fiyat (₺) |
|---|---|-------------|-------------|-----------|
| <b>60X60 KANAL AKSESUARLARI</b> <span style="float: right;">IP40</span>     |   |             |             |           |
| 001 039 060060 01 00  | 60x60 mm İÇ KÖŞE (HAREKETLİ)            | 16          | ad.         | 111,11    |
| 001 040 060060 01 00  | 60x60 mm DIŞ KÖŞE (HAREKETLİ)           | 16          | ad.         | 111,11    |
| 001 041 060060 00 00  | 60x60 mm T KÖŞE                         | 20          | ad.         | 144,44    |
| 001 042 060060 00 00  | 60x60 mm 90 L KÖŞE                      | 24          | ad.         | 144,44    |
| 001 044 060060 00 00  | 60x60 mm UÇ TAPA                        | 30          | ad.         | 77,78     |
| 001 043 060060 00 00  | 60x60 mm EK PARÇASI                     | 25          | ad.         | 77,78     |
| <b>80X40 KANAL AKSESUARLARI</b> <span style="float: right;">IP40</span>     |   |             |             |           |
| 001 039 080040 00 00  | 80x40 mm İÇ KÖŞE                        | 18          | ad.         | 129,63    |
| 001 040 080040 00 00  | 80x40 mm DIŞ KÖŞE                       | 8           | ad.         | 129,63    |
| 001 041 080040 00 00  | 80x40 mm T KÖŞE                         | 12          | ad.         | 148,15    |
| 001 042 080040 00 00  | 80x40 mm 90 L KÖŞE                      | 16          | ad.         | 148,15    |
| 001 044 080040 00 00  | 80x40 mm UÇ TAPA                        | 60          | ad.         | 100,00    |
| 001 043 080040 00 00  | 80x40 mm EK PARÇASI                     | 100         | ad.         | 100,00    |
| <b>80X60 KANAL AKSESUARLARI</b> <span style="float: right;">IP40</span>     |   |             |             |           |
| 001 039 080060 00 00  | 80x60 mm İÇ KÖŞE                        | 12          | ad.         | 137,04    |
| 001 040 080060 00 00  | 80x60 mm DIŞ KÖŞE                       | 8           | ad.         | 137,04    |
| 001 041 080060 00 00  | 80x60 mm T KÖŞE                         | 10          | ad.         | 155,56    |
| 001 042 080060 00 00  | 80x60 mm 90 L KÖŞE                      | 12          | ad.         | 155,56    |
| 001 044 080060 00 00  | 80x60 mm UÇ TAPA                        | 48          | ad.         | 107,41    |
| 001 043 080060 00 00  | 80x60 mm EK PARÇASI                     | 80          | ad.         | 107,41    |
| <b>100X37 KANAL AKSESUARLARI</b> <span style="float: right;">IP40</span>    |   |             |             |           |
| 001 039 100037 00 00  | 100x37 mm İÇ KÖŞE (SABİT)               | 12          | ad.         | 111,11    |
| 001 040 100037 00 00  | 100x37 mm DIŞ KÖŞE (SABİT)              | 8           | ad.         | 111,11    |
| 001 039 100037 01 00  | 100x37 mm İÇ KÖŞE (HAREKETLİ)           | 12          | ad.         | 111,11    |
| 001 040 100037 01 00  | 100x37 mm DIŞ KÖŞE (HAREKETLİ)          | 10          | ad.         | 111,11    |
| 001 041 100037 00 00  | 100x37 mm T PARÇASI                     | 14          | ad.         | 118,52    |
| 001 042 100037 00 00  | 100x37 mm 90 L KÖŞE                     | 14          | ad.         | 118,52    |
| 001 044 100037 00 00  | 100x37 mm UÇ TAPA                       | 50          | ad.         | 59,26     |
| 001 043 100037 00 00  | 100x37 mm EK PARÇA                      | 100         | ad.         | 59,26     |
| 001 050 030003 00 00  | 100X37/41/50 mm KANAL KİLİTLEME APARATI | 75          | ad.         | 22,22     |
| <b>100X40 KANAL AKSESUARLARI</b> <span style="float: right;">IP40</span>    |   |             |             |           |
| 001 039 100040 00 00  | 100x40 mm İÇ KÖŞE (SABİT)               | 8           | ad.         | 133,33    |
| 001 040 100040 00 00  | 100x40 mm DIŞ KÖŞE (SABİT)              | 8           | ad.         | 133,33    |
| 001 039 100040 01 00  | 100x40 mm İÇ KÖŞE (HAREKETLİ)           | 16          | ad.         | 133,33    |
| 001 040 100040 01 00  | 100x40 mm DIŞ KÖŞE (HAREKETLİ)          | 10          | ad.         | 133,33    |
| 001 041 100040 00 00  | 100x40 mm T PARÇASI                     | 12          | ad.         | 162,96    |
| 001 042 100040 00 00  | 100x40 mm 90 L KÖŞE                     | 12          | ad.         | 162,96    |
| 001 044 100060 00 00  | 100x40 mm UÇ TAPA                       | 20          | ad.         | 66,67     |
| 001 043 100060 00 00  | 100x40 mm EK PARÇA                      | 100         | ad.         | 66,67     |
| 001 050 030004 00 00  | 100x40 mm KANAL KİLİTLEME APARATI       | 100         | ad.         | 22,22     |
| 001 013 100040 20 00  | 100x40 mm ARA BÖLME                     | 200         | mt.         | 92,59     |
| <b>100X48 KANAL AKSESUARLARI</b> <span style="float: right;">IP40</span>    |   |             |             |           |
| 001 039 100048 00 00  | 100X48 mm İÇ KÖŞE (SABİT)               | 8           | ad.         | 137,04    |
| 001 040 100048 00 00  | 100X48 mm DIŞ KÖŞE (SABİT)              | 8           | ad.         | 137,04    |
| 001 039 100048 01 00  | 100X48 mm İÇ KÖŞE (HAREKETLİ)           | 10          | ad.         | 137,04    |
| 001 040 100048 01 00  | 100X48 mm DIŞ KÖŞE (HAREKETLİ)          | 10          | ad.         | 137,04    |
| 001 041 100048 00 00  | 100X48 mm T PARÇASI                     | 8           | ad.         | 166,67    |
| 001 042 100048 00 00  | 100X48 mm 90 L KÖŞE                     | 8           | ad.         | 166,67    |
| 001 044 100060 00 00  | 100X48 mm UÇ TAPA                       | 20          | ad.         | 66,67     |
| 001 043 100060 00 00  | 100X48 mm EK PARÇA                      | 100         | ad.         | 66,67     |
| 001 050 030004 00 00  | 100X48 mm KANAL KİLİTLEME APARATI       | 100         | ad.         | 22,22     |
| 001 013 100048 20 00  | 100X48 mm ARA BÖLME                     | 150         | mt.         | 74,07     |
| <b>100X50/41 KANAL AKSESUARLARI</b> <span style="float: right;">IP40</span> |   |             |             |           |
| 001 039 100050 00 00  | 100X50/41 mm İÇ KÖŞE (SABİT)            | 8           | ad.         | 83,52     |
| 001 040 100050 00 00  | 100X50/41 mm DIŞ KÖŞE (SABİT)           | 8           | ad.         | 83,52     |
| 001 039 100050 01 00  | 100X50/41 mm İÇ KÖŞE (HAREKETLİ)        | 10          | ad.         | 83,52     |
| 001 040 100050 01 00  | 100X50/41 mm DIŞ KÖŞE (HAREKETLİ)       | 8           | ad.         | 83,52     |
| 001 041 100050 00 00  | 100X50/41 mm T PARÇASI                  | 10          | ad.         | 103,70    |
| 001 042 100050 00 00  | 100X50/41 mm 90 L KÖŞE                  | 10          | ad.         | 103,70    |
| 001 044 100050 00 00  | 100X50/41 mm UÇ TAPA                    | 40          | ad.         | 59,26     |
| 001 043 100050 00 00  | 100X50/41 mm EK PARÇA                   | 100         | ad.         | 59,26     |
| 001 043 100050 01 00  | 100X50 mm EK PARÇA (3'LÜ SET)           | 100         | ad.         | 70,37     |
| 001 046 195100 00 00  | 100X50 mm KANAL İÇİ KÜP BUAT            | 25          | ad.         | 88,89     |
| 001 013 100048 20 00  | 100X48 - 100x50 mm ARA BÖLME            | 150         | mt.         | 74,07     |
| 001 050 030003 00 00  | 100X37/41/50 mm KANAL KİLİTLEME APARATI | 75          | ad.         | 22,22     |

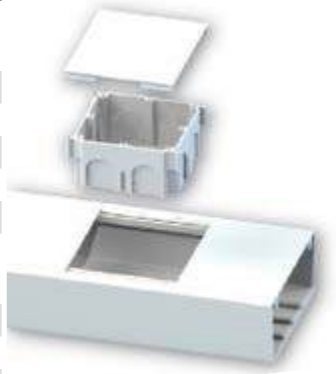
| Ürün Kodu  | Ürün Adı                                   | Amb. (Kutu) | Amb. Birimi | Fiyat (₺) |
|--|--|-------------|-------------|-----------|
| <b>100X50 KAİDESİZ KANAL AKSESUARLARI</b> <span style="float: right;">TS CE IP40</span>                    |  |             |             |           |
| 001 039 100051 00 00   | 100X50 mm KAİDESİZ İÇ KÖŞE                 | 8           | ad.         | 92,59     |
| 001 040 100051 00 00   | 100X50 mm KAİDESİZ DIŞ KÖŞE                | 8           | ad.         | 92,59     |
| 001 041 100051 00 00   | 100X50 mm KAİDESİZ T PARÇASI               | 10          | ad.         | 129,63    |
| 001 042 100051 00 00   | 100X50 mm KAİDESİZ 90 L KÖŞE               | 10          | ad.         | 129,63    |
| 001 043 100051 00 00   | 100X50 mm KAİDESİZ EK PARÇA                | 100         | ad.         | 81,48     |
| 001 044 100051 00 00   | 100X50 mm KAİDESİZ UÇ TAPA                 | 40          | ad.         | 81,48     |
| 001 888 100050 00 00   | 100X50 mm KABLO KANALI MONTAJ APARATI      | 50          | ad.         | 85,19     |
| <b>100X60 KANAL AKSESUARLARI</b> <span style="float: right;">TS CE IP40</span>                             |  |             |             |           |
| 001 039 100060 00 00   | 100X60 mm İÇ KÖŞE (SABİT)                  | 8           | ad.         | 137,04    |
| 001 040 100060 00 00   | 100X60 mm DIŞ KÖŞE (SABİT)                 | 8           | ad.         | 137,04    |
| 001 039 100060 01 00   | 100X60 mm İÇ KÖŞE (HAREKETLİ)              | 8           | ad.         | 137,04    |
| 001 040 100060 01 00   | 100X60 mm DIŞ KÖŞE (HAREKETLİ)             | 10          | ad.         | 137,04    |
| 001 041 100060 00 00   | 100X60 mm T PARÇASI                        | 8           | ad.         | 155,56    |
| 001 042 100060 00 00   | 100X60 mm 90 L KÖŞE                        | 8           | ad.         | 155,56    |
| 001 044 100060 00 00   | 100X60 mm UÇ TAPA                          | 16          | ad.         | 66,67     |
| 001 043 100060 00 00   | 100X60 mm EK PARÇA                         | 100         | ad.         | 66,67     |
| 001 050 030004 00 00   | 100X60 mm KANAL KİLİTLEME APARATI          | 100         | ad.         | 22,22     |
| 001 013 100060 20 00   | 100X60 mm ARA BÖLME                        | 130         | ad.         | 98,15     |
| <b>120X60 KANAL AKSESUARLARI</b> <span style="float: right;">TS CE IP40</span>                             |  |             |             |           |
| 001 039 120060 00 00   | 120X60 mm İÇ KÖŞE                          | 8           | ad.         | 148,15    |
| 001 040 120060 00 00   | 120X60 mm DIŞ KÖŞE                         | 8           | ad.         | 148,15    |
| 001 041 120060 00 00   | 120X60 mm T PARÇA                          | 8           | ad.         | 155,56    |
| 001 042 120060 00 00   | 120X60 mm 90 L KÖŞE                        | 8           | ad.         | 155,56    |
| 001 044 120060 00 00   | 120X60 mm UÇ TAPA                          | 20          | ad.         | 48,15     |
| 001 043 120060 00 00   | 120X60 mm EK PARÇA                         | 50          | ad.         | 48,15     |
| <b>170X50 KANAL AKSESUARLARI</b> <span style="float: right;">TS CE IP40</span>                             |  |             |             |           |
| 001 039 170050 00 00   | 170X50 mm İÇ KÖŞE                          | 32          | ad.         | 177,78    |
| 001 040 170050 00 00   | 170X50 mm DIŞ KÖŞE                         | 44          | ad.         | 177,78    |
| 001 041 170050 00 00   | 170X50 mm T PARÇA                          | 16          | ad.         | 211,11    |
| 001 042 170050 00 00   | 170X50 mm 90 L KÖŞE                        | 16          | ad.         | 211,11    |
| 001 044 170050 00 00   | 170X50 mm UÇ TAPA                          | 125         | ad.         | 59,26     |
| 001 043 170050 00 00   | 170X50 mm EK PARÇA                         | 125         | ad.         | 59,26     |
| <b>İÇTEN KAPAKLI 100X37/50 İÇİN PRİZ MONTAJ SETİ (45x45)</b> <span style="float: right;">TS CE IP40</span> |  |             |             |           |
| 001 047 070001 00 00   | 100X37/50 İÇİN 45X45 PMS (TEKLİ)           | 30          | ad.         | 77,78     |
| 001 047 070002 00 00   | 100X37/50 İÇİN 45X45 PMS (İKİLİ)           | 16          | ad.         | 90,74     |
| 001 047 070003 00 00   | 100X37/50 İÇİN 45X45 PMS (ÜÇLÜ)            | 14          | ad.         | 100,00    |
| 001 047 070004 00 00   | 100X37/50 İÇİN 45X45 PMS (DÖRTLÜ)          | 13          | ad.         | 185,19    |
| <b>İÇTEN KAPAKLI 100X37/50 İÇİN PRİZ MONTAJ SETİ (55X55)</b>   |  |             |             |           |
| 001 047 080001 00 00   | 100X37/50 İÇİN 55X55 PMS (TEKLİ)           | 20          | ad.         | 122,22    |
| 001 047 080002 00 00   | 100X37/50 İÇİN 55X55 PMS (İKİLİ)           | 14          | ad.         | 196,30    |
| 001 047 080003 00 00   | 100X37/50 İÇİN 55X55 PMS (ÜÇLÜ)            | 12          | ad.         | 233,33    |
| <b>DIŞTAN KAPAKLI 100'LÜK KANAL PRİZ MONTAJ SETİ (55X55)</b>   |  |             |             |           |
| 001 047 020001 00 00   | 100'LÜK 55X55 PMS TEKLİ                    | 20          | ad.         | 177,78    |
| 001 047 020002 00 00   | 100'LÜK 55X55 PMS İKİLİ                    | 14          | ad.         | 222,22    |
| 001 047 020003 00 00   | 100'LÜK 55X55 PMS ÜÇLÜ                     | 12          | ad.         | 277,78    |
| <b>DIŞTAN KAPAKLI 100'LÜK KANAL PRİZ MONTAJ SETİ (45x45)</b> <span style="float: right;">TS CE IP40</span> |  |             |             |           |
| 001 047 040001 00 00   | 100'LÜK 45X45 PMS TEKLİ                    | 20          | ad.         | 144,44    |
| 001 047 040002 00 00   | 100'LÜK 45X45 PMS İKİLİ                    | 14          | ad.         | 207,41    |
| 001 047 040003 00 00   | 100'LÜK 45X45 PMS ÜÇLÜ                     | 12          | ad.         | 296,30    |
| 001 047 040004 00 00   | 100'LÜK 45X45 PMS DÖRTLÜ                   | 10          | ad.         | 333,33    |
| <b>İNGİLİZ NORMU PRİZ MONTAJ SETLERİ (100x50/37)</b>   |  |             |             |           |
| 001 047 980001 00 00   | İNGİLİZ NORMU TEKLİ PRİZ TABANI            | 200         | ad.         | 85,19     |
| 001 047 980002 00 00   | İNGİLİZ NORMU İKİLİ PRİZ TABANI            | 100         | ad.         | 88,89     |
| 001 047 990002 00 00   | İNGİLİZ NORMU İKİLİ YÜKSEK TİP PRİZ TABANI | 94          | ad.         | 148,15    |
| 001 166 000001 00 00   | SIVA ALTI ANAHTAR KASASI                   | 28          | ad.         | 75,93     |

001 046 195100 00 00





001 052 300001 00 00

001 052 300002 00 00



888 049 050041



001 052 200003 00 00

001 052 200005 00 00



888 049 050061



888 049 050074



888 049 050076



888 049 050075



888 049 050040

888 049 050043



888 049 050063



888 049 050042



888 049 050051



888 049 050055



888 049 050013



888 049 050008



888 049 050058



888 049 050047



888 049 050056



888 049 050049



## KANAL İÇİN UPS VE ENERJİ PRİZLERİ

CE

| Kod                  | Ürün Tanımı  | Kutu Adedi | Koli Adedi | Fiyat (₺) |
|----------------------|--|------------|------------|-----------|
| 001 052 300001 00 00 | 45X45 TOPRAKLI PRİZ ÇEKİRDEĞİ ÇOCUK KORUMALI (45°) | 50         | 300        | 185,19    |
| 001 052 300002 00 00 | 45X45 UPS PRİZ ÇEKİRDEĞİ ÇOCUK KORUMALI (45°)      | 50         | 300        | 185,19    |
| 001 052 200003 00 00 | 45X45 PRİZ BİRLEŞTİRME APARATI (YANDAN)            | 50         | 500        | 48,15     |
| 001 052 200005 00 00 | 45X45 PRİZ BİRLEŞTİRME APARATI                     | 50         | 500        | 103,70    |
| 888 049 050041       | 45X45 UNİVERSAL PRİZ                               | 10         | 200        | 5,90 \$   |

## KANAL İÇİN ŞARJ PRİZLERİ

CE

| Kod            | Ürün Tanımı                                  | Kutu Adedi | Koli Adedi | Fiyat (\$) |
|----------------|--|------------|------------|------------|
| 888 049 050061 | 45X22,5 USB ŞARJ PRİZİ 5V 2,1A               | 10         | 200        | 22,04 \$   |
| 888 049 050062 | 45X22,5 2'Lİ USB ŞARJ PRİZİ 5V 2,1A          | 20         | 200        | 24,89 \$   |
| 888 049 050074 | 45X45 ŞARJ PRİZİ TYPE-C+TYPE-C (C+C) 5V 4.2A | 10         | 200        | 28,30 \$   |
| 888 049 050075 | 45X45 ŞARJ PRİZİ TYPE-C (C) 5V 3A            | 10         | 200        | 21,43 \$   |
| 888 049 050076 | 45X45 ŞARJ PRİZİ USB+TYPE-C (A+C) 5V 4.2A    | 10         | 200        | 27,54 \$   |

## KANAL İÇİN ANAHTARLAR

CE

| Kod            | Ürün Tanımı                 | Kutu Adedi | Koli Adedi | Fiyat (\$) |
|----------------|-----------------------------|------------|------------|------------|
| 888 049 050040 | 45X22,5 ANAHTAR             | 20         | 400        | 3,36 \$    |
| 888 049 050043 | 45X22,5 VAVİEN              | 20         | 400        | 3,90 \$    |
| 888 049 050063 | 45X45 ANAHTAR               | 10         | 200        | 4,81 \$    |
| 888 049 050044 | 45X45 YAYLI ÇAĞIRMA (LIGHT) | 10         | 200        | 4,81 \$    |
| 888 049 050064 | 45X45 ARA VAVİEN            | 10         | 200        | 6,60 \$    |
| 888 049 050065 | 45X45 VAVİEN                | 10         | 200        | 5,10 \$    |
| 888 049 050042 | 45X45 KOMİTATÖR             | 10         | 200        | 5,90 \$    |

## KANAL İÇİN KONNEKTÖRLER

CE

| Kod            | Ürün Tanımı                            | Kutu Adedi | Koli Adedi | Fiyat (\$) |
|----------------|--|------------|------------|------------|
| 888 049 050051 | 45X22,5 KÖR KAPAK                      | 100        | 1000       | 0,35 \$    |
| 888 049 050055 | 45X45 KÖR KAPAK                        | 100        | 400        | 0,36 \$    |
| 888 049 050012 | 45X22,5 KEYSTONE JACK PANJURLU KAPAK   | 100        | 1000       | 0,47 \$    |
| 888 049 050013 | 45X45 KEYSTONE JACK PANJURLU KAPAK     | 100        | 500        | 0,65 \$    |
| 888 049 050008 | DATA KONNEKTÖRÜ CAT5E (RJ45)           | 100        | 1000       | 1,23 \$    |
| 888 049 050032 | DATA KONNEKTÖRÜ CAT6E (RJ65 8)         | 100        | 1000       | 1,25 \$    |
| 888 049 050009 | TELEFON KONNEKTÖRÜ CAT3 (RJ 11)        | 100        | 1000       | 1,23 \$    |
| 888 049 050058 | 45X22,5 USB 2.0 - AF/AF DATA 90 GİRİŞ  | 50         | 500        | 3,08 \$    |
| 888 049 050059 | 45X22,5 USB 2.0 - AF/AF DATA 180 GİRİŞ | 50         | 500        | 3,08 \$    |

## KANAL İÇİN GÖRÜNTÜ ve SES PRİZLERİ

CE

| Kod            | Ürün Tanımı                    | Kutu Adedi | Koli Adedi | Fiyat (\$) |
|----------------|--------------------------------|------------|------------|------------|
| 888 049 050046 | 45X22,5 HDMI 90 GİRİŞ          | 50         | 500        | 8,76 \$    |
| 888 049 050047 | 45X22,5 VGA DATA JACK          | 50         | 500        | 4,98 \$    |
| 888 049 050056 | 45X22,5 TV PRİZİ ERKEK         | 50         | 500        | 2,23 \$    |
| 888 049 050057 | 45X22,5 TV PRİZİ DIŞI          | 50         | 500        | 2,33 \$    |
| 888 049 050049 | 45X22,5 RCA                    | 50         | 500        | 5,49 \$    |
| 888 049 050060 | 45X22,5 SES JAKI 3,5 mm STEREO | 50         | 500        | 3,02 \$    |

## RACK KABİN ve AKSESUARLARI

| Kod            | Ürün Tanımı                                    | Kutu Adedi | Koli Adedi | Fiyat (₺) |
|----------------|--|------------|------------|-----------|
| 075 171 222508 | 16 MODÜL DÖŞEME ALTI PRİZ SİSTEM (BOŞ) 270X270 | 1          | 10         | 2.037,04  |
| 075 171 333308 | 16 MODÜL DÖŞEME ALTI PRİZ SİSTEM BUATI 352X352 | 1          | 5          | 2.007,41  |

## SİDEM SERİSİ RENKLİ KABLO KANALLARI



| Ürün Kodu            | Ürün Adı                                 | Amb. (Kutu) | Amb. Birimi | Fiyat (₺) |
|----------------------|--|-------------|-------------|-----------|
| 001 007 010008 20 XX | 10X8 mm KABLO KANALI (SİDEM)             | 330         | m           | 88,89     |
| 001 007 012012 20 XX | 12X12 mm KABLO KANALI (SİDEM)            | 250         | m           | 88,89     |
| 001 007 015010 20 XX | 15X10 mm KABLO KANALI (SİDEM)            | 250         | m           | 88,89     |
| 001 007 016016 20 XX | 16X16 mm KABLO KANALI (SİDEM)            | 250         | m           | 111,11    |
| 001 007 020010 20 XX | 20X10 mm KABLO KANALI (SİDEM)            | 200         | m           | 88,89     |
| 001 007 025016 20 XX | 25X16 mm KABLO KANALI (SİDEM)            | 150         | m           | 137,04    |
| 001 007 025025 20 XX | 25X25 mm KABLO KANALI (SİDEM)            | 100         | m           | 170,37    |
| 001 007 930010 20 XX | 30X10 mm KABLO KANALI (SİDEM) BÖLMELİ    | 140         | m           | 151,85    |
| 001 007 930016 20 XX | 30X16 mm KABLO KANALI (SİDEM) BÖLMELİ    | 140         | m           | 200,00    |
| 001 007 030025 20 XX | 30X25 mm KABLO KANALI (SİDEM)            | 80          | m           | 225,00    |
| 001 007 040016 20 XX | 40X16 mm KABLO KANALI (SİDEM)            | 100         | m           | 185,19    |
| 001 007 940016 20 XX | 40X16 mm KABLO KANALI (SİDEM) (BÖLMELİ)  | 100         | m           | 225,00    |
| 001 007 040025 20 XX | 40X25 mm KABLO KANALI (SİDEM)            | 80          | m           | 250,01    |
| 001 007 040040 20 XX | 40X40 mm KABLO KANALI (SİDEM)            | 50          | m           | 275,00    |
| 001 007 960025 20 XX | 60X25 mm KABLO KANALI (SİDEM) BÖLMELİ    | 40          | m           | 400,01    |
| 001 007 060040 20 XX | 60X40 mm KABLO KANALI (SİDEM)            | 40          | m           | 375,00    |
| 001 007 060060 20 XX | 60X60 mm KABLO KANALI (SİDEM)            | 32          | m           | 599,99    |
| 001 007 080040 20 XX | 80X40 mm KABLO KANALI (SİDEM)            | 30          | m           | 599,99    |
| 001 007 080060 20 XX | 80X60 mm KABLO KANALI (SİDEM)            | 24          | m           | 650,00    |
| 001 007 100040 20 XX | 100X40 mm KABLO KANALI (SİDEM)           | 24          | m           | 700,00    |
| 001 007 100048 20 XX | 100X48 mm KABLO KANALI (SİDEM)           | 24          | m           | 700,00    |
| 001 007 100060 20 XX | 100X60 mm KABLO KANALI (SİDEM)           | 20          | m           | 950,00    |
| 001 007 075060 20 XX | 75X60 mm KABLO KANALI (SİDEM)            | 30          | m           | 650,00    |
| 001 007 100037 20 XX | 100X37 mm KABLO KANALI (SİDEM) İ.KAPAKLI | 30          | m           | 750,01    |
| 001 007 100050 20 XX | 100X50 mm KABLO KANALI (SİDEM) İ.KAPAKLI | 20          | m           | 800,00    |
| 001 007 120060 20 XX | 120X60 mm KABLO KANALI (SİDEM) İ.KAPAKLI | 16          | m           | 1.050,00  |
| 001 007 120070 20 XX | 120X70 mm KABLO KANALI (SİDEM)           | 16          | m           | 1.350,00  |
| 001 007 170070 20 XX | 170X70 mm KABLO KANALI (SİDEM)           | 12          | m           | 1.700,00  |

### SİDEM SERİSİ RENKLİ KABLO KANALLARI (YAPIŞKANLI)



|                      |  |     |   |        |
|----------------------|--|-----|---|--------|
| 001 155 010008 20 XX | 10X8 mm KABLO KANALI (SİDEM) YAPIŞKANLI  | 330 | m | 144,44 |
| 001 155 012012 20 XX | 12X12 mm KABLO KANALI (SİDEM) YAPIŞKANLI | 250 | m | 144,44 |
| 001 155 015010 20 XX | 15X10 mm KABLO KANALI (SİDEM) YAPIŞKANLI | 250 | m | 144,44 |
| 001 155 016016 20 XX | 16X16 mm KABLO KANALI (SİDEM) YAPIŞKANLI | 240 | m | 177,78 |
| 001 155 020010 20 XX | 20X10 mm KABLO KANALI (SİDEM) YAPIŞKANLI | 180 | m | 144,44 |
| 001 155 025016 20 XX | 25X16 mm KABLO KANALI (SİDEM) YAPIŞKANLI | 150 | m | 222,22 |
| 001 155 025025 20 XX | 25X25 mm KABLO KANALI (SİDEM) YAPIŞKANLI | 100 | m | 259,26 |
| 001 155 930010 20 XX | 30X10 mm KABLO KANALI (SİDEM) YAPIŞKANLI | 140 | m | 203,70 |
| 001 155 930016 20 XX | 30X16 mm KABLO KANALI (SİDEM) YAPIŞKANLI | 140 | m | 259,26 |
| 001 155 030025 20 XX | 30X25 mm KABLO KANALI (SİDEM) YAPIŞKANLI | 80  | m | 296,30 |
| 001 155 040016 20 XX | 40X16 mm KABLO KANALI (SİDEM) YAPIŞKANLI | 100 | m | 300,00 |
| 001 155 040025 20 XX | 40X25 mm KABLO KANALI (SİDEM) YAPIŞKANLI | 80  | m | 370,37 |
| 001 155 040040 20 XX | 40X40 mm KABLO KANALI (SİDEM) YAPIŞKANLI | 50  | m | 407,41 |
| 001 155 960025 20 XX | 60X25 mm KABLO KANALI (SİDEM) YAPIŞKANLI | 40  | m | 592,59 |
| 001 155 060040 20 XX | 60X40 mm KABLO KANALI (SİDEM) YAPIŞKANLI | 40  | m | 611,11 |

### SİDEM SERİSİ SÜPÜRGELİKLER ve AKSESUARLARI

|                      |                                       |    |   |        |
|----------------------|---------------------------------------|----|---|--------|
| 001 007 974020 20 XX | 74X20 mm KABLO KANALI (SİDEM) BÖLMELİ | 50 | m | 407,41 |
| 001 007 975022 20 XX | 75X22 mm KABLO KANALI (SİDEM) BÖLMELİ | 50 | m | 555,56 |

### SİDEM SERİSİ BALIK SIRTI ZEMİN KANALLARI ve AKSESUARLARI

|                      |                                 |    |     |        |
|----------------------|---------------------------------|----|-----|--------|
| 001 007 050013 20 XX | 50X13 mm KABLO KANALI (SİDEM)   | 60 | m   | 296,30 |
| 001 007 060015 20 XX | 60X15 mm KABLO KANALI (SİDEM)   | 40 | m   | 333,33 |
| 001 031 060015 00 XX | 60X15 mm L KÖŞE(SİDEM)          | 1  | ad. | 148,15 |
| 001 032 060015 00 XX | 60X15 mm EK PARÇA (SİDEM)       | 1  | ad. | 92,59  |
| 001 033 060015 00 XX | 60X15 mm SONLAMA KAPAĞI (SİDEM) | 1  | ad. | 92,59  |
| 001 030 060015 00 XX | 60X15 mm T KÖŞE (SİDEM)         | 1  | ad. | 166,67 |
| 001 007 075018 20 XX | 75X18 mm KABLO KANALI (SİDEM)   | 30 | m   | 481,48 |
| 001 007 090020 20 XX | 90X20 mm KABLO KANALI (SİDEM)   | 20 | m   | 740,74 |



SIYAH  
BLACK  
MUT-11



GÜMÜŞ  
SILVER  
MUT-56



ARMUT  
PEAR  
MUT-01



DAMARLI BEJ  
RIBBED BEIGE  
MUT-51



MERBAU  
MERBAU  
MUT-02



KIZIL KAHVE  
SCARLET BROWN  
MUT-52



KOYU CEVİZ  
DARK WALNUT  
MUT-03



DAMARLI KAHVE  
RIBBED BROWN  
MUT-53



AÇIK KAYIN  
LIGHT BEECH  
MUT-04



DAMARLI AÇIK BEJ  
RIBBED LIGHT BEIGE  
MUT-54



MAUN  
MAHOGANY  
MUT-05



DAMARLI KIZIL  
RIBBED SCARLED  
MUT-55

| Ürün Kodu  | Ürün Adı                                 | Amb. (Kutu) | Amb. Birimi | Fiyat (₺) |
|--|--|-------------|-------------|-----------|
| <b>SİDEM SERİSİ BALIK SIRTI ZEMİN KANALLARI (YAPIŞKANLI)</b> |  |             |             |           |
| 001 155 050013 20 XX   | 50X13 mm KABLO KANALI (SİDEM) YAPIŞKANLI | 60          | m           | 444,44    |
| 001 155 060015 20 XX   | 60X15 mm KABLO KANALI (SİDEM) YAPIŞKANLI | 40          | m           | 462,96    |
| 001 155 075018 20 XX   | 75X18 mm KABLO KANALI (SİDEM) YAPIŞKANLI | 30          | m           | 518,52    |
| <b>12x12 KANAL AKSESUARLARI - SİDEM SERİSİ</b>               |  |             |             |           |
| 001 028 012012 00 XX   | 12X12 mm (SİDEM) İÇ KÖŞE                 | 1           | ad.         | 78,63     |
| 001 029 012012 00 XX   | 12X12 mm (SİDEM) DIŞ KÖŞE                | 1           | ad.         | 78,63     |
| 001 030 012012 00 XX   | 12X12 mm (SİDEM) T KÖŞE                  | 1           | ad.         | 77,64     |
| 001 031 012012 00 XX   | 12X12 mm (SİDEM) 90 L KÖŞE               | 1           | ad.         | 77,64     |
| 001 033 012012 00 XX   | 12X12 mm (SİDEM) UÇ TAPA                 | 1           | ad.         | 55,12     |
| 001 032 012012 00 XX   | 12X12 mm (SİDEM) EK PARÇASI              | 1           | ad.         | 55,12     |
| <b>15x10 KANAL AKSESUARLARI - SİDEM SERİSİ</b>               |  |             |             |           |
| 001 028 015010 00 XX   | 15X10 mm (SİDEM) İÇ KÖŞE                 | 1           | ad.         | 50,74     |
| 001 029 015010 00 XX   | 15X10 mm (SİDEM) DIŞ KÖŞE                | 1           | ad.         | 50,74     |
| 001 030 015010 00 XX   | 15X10 mm (SİDEM) T KÖŞE                  | 1           | ad.         | 80,03     |
| 001 031 015010 00 XX   | 15X10 mm (SİDEM) 90 L KÖŞE               | 1           | ad.         | 80,03     |
| 001 033 015010 00 XX   | 15X10 mm (SİDEM) UÇ TAPA                 | 1           | ad.         | 46,85     |
| 001 032 015010 00 XX   | 15X10 mm (SİDEM) EK PARÇASI              | 1           | ad.         | 46,85     |
| <b>16x16 KANAL AKSESUARLARI - SİDEM SERİSİ</b>               |  |             |             |           |
| 001 028 016016 00 XX   | 16x16 mm (SİDEM) İÇ KÖŞE                 | 1           | ad.         | 48,67     |
| 001 029 016016 00 XX   | 16x16 mm (SİDEM) DIŞ KÖŞE                | 1           | ad.         | 48,67     |
| 001 030 016016 00 XX   | 16x16 mm (SİDEM) T KÖŞE                  | 1           | ad.         | 92,29     |
| 001 031 016016 00 XX   | 16x16 mm (SİDEM) 90 L KÖŞE               | 1           | ad.         | 92,29     |
| 001 033 016016 00 XX   | 16x16 mm (SİDEM) UÇ TAPA                 | 1           | ad.         | 45,92     |
| 001 032 016016 00 XX   | 16x16 mm (SİDEM) EK PARÇASI              | 1           | ad.         | 45,92     |
| <b>20x10 KANAL AKSESUARLARI - SİDEM SERİSİ</b>               |  |             |             |           |
| 001 028 020010 00 XX   | 20x10 mm (SİDEM) İÇ KÖŞE                 | 1           | ad.         | 72,69     |
| 001 029 020010 00 XX   | 20x10 mm (SİDEM) DIŞ KÖŞE                | 1           | ad.         | 72,69     |
| 001 030 020010 00 XX   | 20x10 mm (SİDEM) T KÖŞE                  | 1           | ad.         | 76,02     |
| 001 031 020010 00 XX   | 20x10 mm (SİDEM) 90 L KÖŞE               | 1           | ad.         | 76,02     |
| 001 033 020010 00 XX   | 20x10 mm (SİDEM) UÇ TAPA                 | 1           | ad.         | 51,53     |
| 001 032 020010 00 XX   | 20x10 mm (SİDEM) EK PARÇASI              | 1           | ad.         | 51,53     |
| <b>TAVAN KÖŞE KANALI (23x23) AKSESUARLARI -SİDEM SERİSİ</b>  |  |             |             |           |
| 001 041 023023 00 XX   | 23X23 mm T PARÇASI                       | 1           | ad.         | 213,79    |
| 001 042 023023 00 XX   | 23X23 mm 90 L KÖŞE                       | 1           | ad.         | 213,79    |
| 001 043 023023 00 XX   | 23X23 mm EK PARÇA                        | 1           | ad.         | 55,59     |
| 001 044 023023 00 XX   | 23X23 mm UÇ TAPA                         | 1           | ad.         | 55,59     |
| <b>25x16 KANAL AKSESUARLARI - SİDEM SERİSİ</b>               |  |             |             |           |
| 001 028 025016 00 XX   | 25X16 mm (SİDEM) İÇ KÖŞE                 | 1           | ad.         | 92,51     |
| 001 029 025016 00 XX   | 25X16 mm (SİDEM) DIŞ KÖŞE                | 1           | ad.         | 92,51     |
| 001 030 025016 00 XX   | 25X16 mm (SİDEM) T KÖŞE                  | 1           | ad.         | 103,92    |
| 001 031 025016 00 XX   | 25X16 mm (SİDEM) 90 L KÖŞE               | 1           | ad.         | 103,92    |
| 001 033 025016 00 XX   | 25X16 mm (SİDEM) UÇ TAPA                 | 1           | ad.         | 60,67     |
| 001 032 025016 00 XX   | 25X16 mm (SİDEM) EK PARÇA                | 1           | ad.         | 60,67     |
| 001 034 017421 00 XX   | 25X16 mm (SİDEM) PMK (45X45)             | 1           | ad.         | 929,78    |
| <b>25x25 KANAL AKSESUARLARI - SİDEM SERİSİ</b>               |  |             |             |           |
| 001 028 025025 00 XX   | 25x25 mm (SİDEM) İÇ KÖŞE                 | 1           | ad.         | 69,61     |
| 001 029 025025 00 XX   | 25x25 mm (SİDEM) DIŞ KÖŞE                | 1           | ad.         | 69,61     |
| 001 030 025025 00 XX   | 25x25 mm (SİDEM) T PARÇASI               | 1           | ad.         | 97,53     |
| 001 031 025025 00 XX   | 25x25 mm (SİDEM) 90 L KÖŞE               | 1           | ad.         | 97,53     |
| 001 033 025025 00 XX   | 25x25 mm (SİDEM) UÇ TAPA                 | 1           | ad.         | 50,47     |
| 001 032 025025 00 XX   | 25x25 mm (SİDEM) EK PARÇA                | 1           | ad.         | 50,47     |
| 001 034 017421 00 XX   | 25x25 mm (SİDEM) PMK (45X45)             | 1           | ad.         | 929,78    |

| Ürün Kodu                                      | Ürün Adı                     | Amb. (Kutu) | Amb. Birimi | Fiyat (₺) |
|--|------------------------------|-------------|-------------|-----------|
| <b>30x10 KANAL AKSESUARLARI - SİDEM SERİSİ</b> |                              |             |             | <b>CE</b> |
| 001 028 030010 00 XX                           | 30X10 mm (SİDEM) İÇ KÖŞE     | 1           | ad.         | 109,50    |
| 001 029 030010 00 XX                           | 30X10 mm (SİDEM) DIŞ KÖŞE    | 1           | ad.         | 109,50    |
| 001 030 030010 00 XX                           | 30X10 mm (SİDEM) T PARÇASI   | 1           | ad.         | 117,20    |
| 001 031 030010 00 XX                           | 30X10 mm (SİDEM) 90 L KÖŞE   | 1           | ad.         | 117,20    |
| 001 033 030010 00 XX                           | 30X10 mm (SİDEM) UÇ TAPA     | 1           | ad.         | 54,40     |
| 001 032 030010 00 XX                           | 30X10 mm (SİDEM) EK PARÇA    | 1           | ad.         | 54,40     |
| <b>30x16 KANAL AKSESUARLARI - SİDEM SERİSİ</b> |                              |             |             | <b>CE</b> |
| 001 028 030016 00 XX                           | 30x16 mm (SİDEM) İÇ KÖŞE     | 1           | ad.         | 108,01    |
| 001 029 030016 00 XX                           | 30x16 mm (SİDEM) DIŞ KÖŞE    | 1           | ad.         | 108,01    |
| 001 030 030016 00 XX                           | 30x16 mm (SİDEM) T PARÇASI   | 1           | ad.         | 145,32    |
| 001 031 030016 00 XX                           | 30x16 mm (SİDEM) 90 L KÖŞE   | 1           | ad.         | 145,32    |
| 001 033 030016 00 XX                           | 30x16 mm (SİDEM) UÇ TAPA     | 1           | ad.         | 61,14     |
| 001 032 030016 00 XX                           | 30x16 mm (SİDEM) EK PARÇA    | 1           | ad.         | 61,14     |
| <b>30x25 KANAL AKSESUARLARI - SİDEM SERİSİ</b> |                              |             |             | <b>CE</b> |
| 001 028 030025 00 XX                           | 30X25 mm (SİDEM) İÇ KÖŞE     | 1           | ad.         | 114,41    |
| 001 029 030025 00 XX                           | 30X25 mm (SİDEM) DIŞ KÖŞE    | 1           | ad.         | 114,41    |
| 001 030 030025 00 XX                           | 30X25 mm (SİDEM) T PARÇASI   | 1           | ad.         | 147,10    |
| 001 031 030025 00 XX                           | 30X25 mm (SİDEM) 90 L KÖŞE   | 1           | ad.         | 147,10    |
| 001 033 030025 00 XX                           | 30X25 mm (SİDEM) UÇ TAPA     | 1           | ad.         | 64,16     |
| 001 032 030025 00 XX                           | 30X25 mm (SİDEM) EK PARÇA    | 1           | ad.         | 64,16     |
| <b>40x16 KANAL AKSESUARLARI - SİDEM SERİSİ</b> |                              |             |             | <b>CE</b> |
| 001 028 040016 00 XX                           | 40x16 mm (SİDEM) İÇ KÖŞE     | 1           | ad.         | 116,31    |
| 001 029 040016 00 XX                           | 40x16 mm (SİDEM) DIŞ KÖŞE    | 1           | ad.         | 116,31    |
| 001 030 040016 00 XX                           | 40x16 mm (SİDEM) T PARÇASI   | 1           | ad.         | 155,06    |
| 001 031 040016 00 XX                           | 40x16 mm (SİDEM) 90 L KÖŞE   | 1           | ad.         | 155,06    |
| 001 033 040016 00 XX                           | 40x16 mm (SİDEM) UÇ TAPA     | 1           | ad.         | 78,33     |
| 001 032 040016 00 XX                           | 40x16 mm (SİDEM) EK PARÇA    | 1           | ad.         | 78,33     |
| 001 034 017421 00 XX                           | 40X16 mm (SİDEM) PMK (45X45) | 1           | ad.         | 929,78    |
| <b>40x25 KANAL AKSESUARLARI - SİDEM SERİSİ</b> |                              |             |             | <b>CE</b> |
| 001 028 040025 00 XX                           | 40X25 mm (SİDEM) İÇ KÖŞE     | 1           | ad.         | 134,72    |
| 001 029 040025 00 XX                           | 40X25 mm (SİDEM) DIŞ KÖŞE    | 1           | ad.         | 134,72    |
| 001 030 040025 00 XX                           | 40X25 mm (SİDEM) T KÖŞE      | 1           | ad.         | 168,27    |
| 001 031 040025 00 XX                           | 40X25 mm (SİDEM) 90 L KÖŞE   | 1           | ad.         | 168,27    |
| 001 033 040025 00 XX                           | 40X25 mm (SİDEM) UÇ TAPA     | 1           | ad.         | 89,96     |
| 001 032 040025 00 XX                           | 40X25 mm (SİDEM) EK PARÇASI  | 1           | ad.         | 89,96     |
| 001 034 017421 00 XX                           | 40X25 mm (SİDEM) PMK (45X45) | 1           | ad.         | 929,78    |
| <b>40x40 KANAL AKSESUARLARI - SİDEM SERİSİ</b> |                              |             |             | <b>CE</b> |
| 001 028 040040 00 XX                           | 40x40 mm (SİDEM) İÇ KÖŞE     | 1           | ad.         | 142,38    |
| 001 029 040040 00 XX                           | 40x40 mm (SİDEM) DIŞ KÖŞE    | 1           | ad.         | 142,38    |
| 001 030 040040 00 XX                           | 40x40 mm (SİDEM) T KÖŞE      | 1           | ad.         | 149,39    |
| 001 031 040040 00 XX                           | 40x40 mm (SİDEM) 90 L KÖŞE   | 1           | ad.         | 149,38    |
| 001 033 040040 00 XX                           | 40x40 mm (SİDEM) UÇ TAPA     | 1           | ad.         | 108,44    |
| 001 032 040040 00 XX                           | 40x40 mm (SİDEM) EK PARÇASI  | 1           | ad.         | 108,44    |
| 001 034 017421 00 XX                           | 40X40 mm (SİDEM) PMK (45X45) | 1           | ad.         | 929,78    |
| <b>60x25 KANAL AKSESUARLARI - SİDEM SERİSİ</b> |                              |             |             | <b>CE</b> |
| 001 028 060025 00 XX                           | 60x25 mm (SİDEM) İÇ KÖŞE     | 1           | ad.         | 149,80    |
| 001 029 060025 00 XX                           | 60x25 mm (SİDEM) DIŞ KÖŞE    | 1           | ad.         | 149,80    |
| 001 030 060025 00 XX                           | 60x25 mm (SİDEM) T KÖŞE      | 1           | ad.         | 161,32    |
| 001 031 060025 00 XX                           | 60x25 mm (SİDEM) 90 L KÖŞE   | 1           | ad.         | 161,32    |
| 001 033 060025 00 XX                           | 60x25 mm (SİDEM) UÇ TAPA     | 1           | ad.         | 109,09    |
| 001 032 060025 00 XX                           | 60x25 mm (SİDEM) EK PARÇASI  | 1           | ad.         | 109,09    |



L KÖŞE



EK PARÇA



UÇ TAPA





İÇ KÖŞE



DIŞ KÖŞE



T KÖŞE



L KÖŞE



EK PARÇA



UÇ TAPA

| Ürün Kodu                                       | Ürün Adı                               | Amb. (Kutu) | Amb. Birimi | Fiyat (₺) |
|---|--|-------------|-------------|-----------|
| <b>60x40 KANAL AKSESUARLARI - SİDEM SERİSİ</b>  |  |             |             | <b>CE</b> |
| 001 028 060040 00 XX                            | 60x40 mm (SİDEM) İÇ KÖŞE               | 1           | ad.         | 154,88    |
| 001 029 060040 00 XX                            | 60x40 mm (SİDEM) DIŞ KÖŞE              | 1           | ad.         | 154,88    |
| 001 030 060040 00 XX                            | 60x40 mm (SİDEM) T KÖŞE                | 1           | ad.         | 162,43    |
| 001 031 060040 00 XX                            | 60x40 mm (SİDEM) 90 L KÖŞE             | 1           | ad.         | 162,43    |
| 001 033 060040 00 XX                            | 60x40 mm (SİDEM) UÇ TAPA               | 1           | ad.         | 113,04    |
| 001 032 060040 00 XX                            | 60x40 mm (SİDEM) EK PARÇA              | 1           | ad.         | 113,04    |
| <b>60x60 KANAL AKSESUARLARI - SİDEM SERİSİ</b>  |  |             |             | <b>CE</b> |
| 001 028 060060 00 XX                            | 60x60 mm (SİDEM) İÇ KÖŞE               | 1           | ad.         | 192,46    |
| 001 029 060060 00 XX                            | 60x60 mm (SİDEM) DIŞ KÖŞE              | 1           | ad.         | 192,46    |
| 001 030 060060 00 XX                            | 60x60 mm (SİDEM) T PARÇASI             | 1           | ad.         | 221,55    |
| 001 031 060060 00 XX                            | 60x60 mm (SİDEM) 90 L KÖŞE             | 1           | ad.         | 221,55    |
| 001 033 060060 00 XX                            | 60x60 mm (SİDEM) UÇ TAPA               | 1           | ad.         | 132,03    |
| 001 032 060060 00 XX                            | 60x60 mm (SİDEM) EK PARÇA              | 1           | ad.         | 132,03    |
| <b>74x20 KANAL AKSESUARLARI - SİDEM SERİSİ</b>  |  |             |             | <b>CE</b> |
| 001 028 074020 00 XX                            | 74x20 mm (SİDEM) İÇ KÖŞE               | 1           | ad.         | 160,35    |
| 001 029 074020 00 XX                            | 74x20 mm (SİDEM) DIŞ KÖŞE              | 1           | ad.         | 160,35    |
| 001 030 074020 00 XX                            | 74x20 mm (SİDEM) T PARÇASI             | 1           | ad.         | 167,24    |
| 001 031 074020 00 XX                            | 74x20 mm (SİDEM) 90 L KÖŞE             | 1           | ad.         | 167,24    |
| 001 032 074020 00 XX                            | 74x20 mm (SİDEM) UÇ TAPA               | 1           | ad.         | 151,85    |
| 001 033 074020 00 XX                            | 74x20 mm (SİDEM) EK PARÇA              | 1           | ad.         | 151,85    |
| 001 036 017420 00 XX                            | 74x20 mm (SİDEM) PRİZ MONTAJ KASASI    | 1           | ad.         | 1.641,98  |
| <b>75x22 KANAL AKSESUARLARI - SİDEM SERİSİ</b>  |  |             |             | <b>CE</b> |
| 001 028 075022 00 XX                            | 75x22 mm (SİDEM) İÇ KÖŞE               | 1           | ad.         | 147,79    |
| 001 029 075022 00 XX                            | 75x22 mm (SİDEM) DIŞ KÖŞE              | 1           | ad.         | 147,79    |
| 001 033 075022 01 XX                            | 75x22 mm (SİDEM) SAĞ SONLAMA           | 1           | ad.         | 202,47    |
| 001 033 075022 02 XX                            | 75x22 mm (SİDEM) SOL SONLAMA           | 1           | ad.         | 202,47    |
| 001 032 075022 00 XX                            | 75x22 mm (SİDEM) EK PARÇASI            | 1           | ad.         | 134,09    |
| <b>80x40 KANAL AKSESUARLARI - SİDEM SERİSİ</b>  |  |             |             | <b>CE</b> |
| 001 028 080040 00 XX                            | 80x40 mm (SİDEM) İÇ KÖŞE               | 1           | ad.         | 204,42    |
| 001 029 080040 00 XX                            | 80x40 mm (SİDEM) DIŞ KÖŞE              | 1           | ad.         | 204,42    |
| 001 030 080040 00 XX                            | 80x40 mm (SİDEM) T PARÇASI             | 1           | ad.         | 223,57    |
| 001 031 080040 00 XX                            | 80x40 mm (SİDEM) 90 L KÖŞE             | 1           | ad.         | 223,57    |
| 001 033 080040 00 XX                            | 80x40 mm (SİDEM) UÇ TAPA               | 1           | ad.         | 174,23    |
| 001 032 080040 00 XX                            | 80x40 mm (SİDEM) EK PARÇA              | 1           | ad.         | 174,23    |
| <b>80x60 KANAL AKSESUARLARI - SİDEM SERİSİ</b>  |  |             |             | <b>CE</b> |
| 001 028 080060 00 XX                            | 80x60 mm (SİDEM) İÇ KÖŞE               | 1           | ad.         | 266,21    |
| 001 029 080060 00 XX                            | 80x60 mm (SİDEM) DIŞ KÖŞE              | 1           | ad.         | 266,21    |
| 001 030 080060 00 XX                            | 80x60 mm (SİDEM) T PARÇASI             | 1           | ad.         | 232,86    |
| 001 031 080060 00 XX                            | 80x60 mm (SİDEM) 90 L KÖŞE             | 1           | ad.         | 232,86    |
| 001 033 080060 00 XX                            | 80x60 mm (SİDEM) UÇ TAPA               | 1           | ad.         | 167,27    |
| 001 032 080060 00 XX                            | 80x60 mm (SİDEM) EK PARÇA              | 1           | ad.         | 167,27    |
| <b>100x37 KANAL AKSESUARLARI - SİDEM SERİSİ</b> |  |             |             | <b>CE</b> |
| 001 028 100037 00 XX                            | 100x37 mm (SİDEM) İÇ KÖŞE (SABİT)      | 1           | ad.         | 328,40    |
| 001 029 100037 00 XX                            | 100x37 mm (SİDEM) DIŞ KÖŞE (SABİT)     | 1           | ad.         | 328,40    |
| 001 028 100037 01 XX                            | 100x37 mm (SİDEM) İÇ KÖŞE (HAREKETLİ)  | 1           | ad.         | 328,40    |
| 001 029 100037 01 XX                            | 100x37 mm (SİDEM) DIŞ KÖŞE (HAREKETLİ) | 1           | ad.         | 328,40    |
| 001 030 100037 00 XX                            | 100x37 mm (SİDEM) T PARÇASI            | 1           | ad.         | 349,88    |
| 001 031 100037 00 XX                            | 100x37 mm (SİDEM) 90 L KÖŞE            | 1           | ad.         | 349,88    |
| 001 033 100037 00 XX                            | 100x37 mm (SİDEM) UÇ TAPA              | 1           | ad.         | 229,17    |
| 001 032 100037 00 XX                            | 100x37 mm (SİDEM) EK PARÇA             | 1           | ad.         | 229,17    |

| Ürün Kodu   | Ürün Adı                               | Amb. (Kutu) | Amb. Birimi | Fiyat (₺) |
|---|--|-------------|-------------|-----------|
| <b>100x40 KANAL AKSESUARLARI - SİDEM SERİSİ</b>             |  |             |             | <b>CE</b> |
| 001 028 100040 00 XX  | 100X40 mm (SİDEM) İÇ KÖŞE (SABİT)      | 1           | ad.         | 342,43    |
| 001 029 100040 00 XX  | 100X40 mm (SİDEM) DIŞ KÖŞE (SABİT)     | 1           | ad.         | 342,43    |
| 001 028 100040 01 XX  | 100X40 mm (SİDEM) İÇ KÖŞE (HAREKETLİ)  | 1           | ad.         | 342,43    |
| 001 029 100040 01 XX  | 100X40 mm (SİDEM) DIŞ KÖŞE (HAREKETLİ) | 1           | ad.         | 342,43    |
| 001 030 100040 00 XX  | 100X40 mm (SİDEM) T PARÇASI            | 1           | ad.         | 356,04    |
| 001 031 100040 00 XX  | 100X40 mm (SİDEM) 90 L KÖŞE            | 1           | ad.         | 356,04    |
| 001 033 100040 00 XX  | 100X40 mm (SİDEM) UÇ TAPA              | 1           | ad.         | 232,93    |
| 001 032 100040 00 XX  | 100X40 mm (SİDEM) EK PARÇA             | 1           | ad.         | 232,93    |
| <b>100x48 KANAL AKSESUARLARI - SİDEM SERİSİ</b>             |  |             |             | <b>CE</b> |
| 001 028 100048 00 XX  | 100X48 mm (SİDEM) İÇ KÖŞE (SABİT)      | 1           | ad.         | 369,86    |
| 001 029 100048 00 XX  | 100X48 mm (SİDEM) DIŞ KÖŞE (SABİT)     | 1           | ad.         | 369,86    |
| 001 028 100048 01 XX  | 100X48 mm (SİDEM) İÇ KÖŞE (HAREKETLİ)  | 1           | ad.         | 369,86    |
| 001 029 100048 01 XX  | 100X48 mm (SİDEM) DIŞ KÖŞE (HAREKETLİ) | 1           | ad.         | 369,86    |
| 001 030 100048 00 XX  | 100X48 mm (SİDEM) T PARÇASI            | 1           | ad.         | 382,63    |
| 001 031 100048 00 XX  | 100X48 mm (SİDEM) 90 L KÖŞE            | 1           | ad.         | 382,63    |
| 001 033 100048 00 XX  | 100X48 mm (SİDEM) UÇ TAPA              | 1           | ad.         | 247,58    |
| 001 032 100048 00 XX  | 100X48 mm (SİDEM) EK PARÇA             | 1           | ad.         | 247,58    |
| <b>100x50 KANAL AKSESUARLARI - SİDEM SERİSİ</b>             |  |             |             | <b>CE</b> |
| 001 028 100050 00 XX  | 100X50 mm (SİDEM) İÇ KÖŞE (SABİT)      | 1           | ad.         | 324,45    |
| 001 029 100050 00 XX  | 100X50 mm (SİDEM) DIŞ KÖŞE (SABİT)     | 1           | ad.         | 324,45    |
| 001 028 100050 01 XX  | 100X50 mm (SİDEM) İÇ KÖŞE (HAREKETLİ)  | 1           | ad.         | 324,45    |
| 001 029 100050 01 XX  | 100X50 mm (SİDEM) DIŞ KÖŞE (HAREKETLİ) | 1           | ad.         | 324,45    |
| 001 030 100050 00 XX  | 100X50 mm (SİDEM) T PARÇASI            | 1           | ad.         | 331,76    |
| 001 031 100050 00 XX  | 100X50 mm (SİDEM) 90 L KÖŞE            | 1           | ad.         | 331,76    |
| 001 033 100050 00 XX  | 100X50 mm (SİDEM) UÇ TAPA              | 1           | ad.         | 215,57    |
| 001 032 100050 00 XX  | 100X50 mm (SİDEM) EK PARÇA             | 1           | ad.         | 215,57    |
| <b>100x60 KANAL AKSESUARLARI - SİDEM SERİSİ</b>             |  |             |             | <b>CE</b> |
| 001 028 100060 00 XX  | 100X60 mm (SİDEM) İÇ KÖŞE (SABİT)      | 1           | ad.         | 366,31    |
| 001 029 100060 00 XX  | 100X60 mm (SİDEM) DIŞ KÖŞE (SABİT)     | 1           | ad.         | 366,31    |
| 001 028 100060 01 XX  | 100X60 mm (SİDEM) İÇ KÖŞE (HAREKETLİ)  | 1           | ad.         | 366,31    |
| 001 029 100060 01 XX  | 100X60 mm (SİDEM) DIŞ KÖŞE (HAREKETLİ) | 1           | ad.         | 366,31    |
| 001 030 100060 00 XX  | 100X60 mm (SİDEM) T PARÇASI            | 1           | ad.         | 398,97    |
| 001 031 100060 00 XX  | 100X60 mm (SİDEM) 90 L KÖŞE            | 1           | ad.         | 398,97    |
| 001 033 100060 00 XX  | 100X60 mm (SİDEM) UÇ TAPA              | 1           | ad.         | 236,28    |
| 001 032 100060 00 XX  | 100X60 mm (SİDEM) EK PARÇA             | 1           | ad.         | 236,28    |
| <b>İÇTEN KAPAKLI 100x37/50 İÇİN PMS - SİDEM SERİSİ</b>      |  |             |             | <b>CE</b> |
| 001 034 400001 00 XX  | 100X37/50 (SİDEM) 45X45 PMS TEKLİ      | 1           | ad.         | 192,61    |
| 001 034 400002 00 XX  | 100X37/50 (SİDEM) 45X45 PMS İKİLİ      | 1           | ad.         | 205,43    |
| 001 034 400003 00 XX  | 100X37/50 (SİDEM) 45X45 PMS ÜÇLÜ       | 1           | ad.         | 215,79    |
| 001 034 400004 00 XX  | 100X37/50 (SİDEM) 45X45 PMS DÖRTLÜ     | 1           | ad.         | 326,61    |
| 001 034 500001 00 XX  | 100X37/50 (SİDEM) 55X55 PMS TEKLİ      | 1           | ad.         | 275,59    |
| 001 034 500002 00 XX  | 100X37/50 (SİDEM) 55X55 PMS İKİLİ      | 1           | ad.         | 317,52    |
| 001 034 500003 00 XX  | 100X37/50 (SİDEM) 55X55 PMS ÜÇLÜ       | 1           | ad.         | 343,90    |
| <b>DIŞTAN KAPAKLI 100'LÜK PMS 55x55 İÇİN - SİDEM SERİSİ</b> |  |             |             | <b>CE</b> |
| 001 034 000001 00 XX  | 100'LÜK 55X55 PMS TEKLİ SİDEM          | 1           | ad.         | 401,66    |
| 001 034 000002 00 XX  | 100'LÜK 55X55 PMS İKİLİ SİDEM          | 1           | ad.         | 490,53    |
| 001 034 000003 00 XX  | 100'LÜK 55X55 PMS ÜÇLÜ SİDEM           | 1           | ad.         | 556,69    |
| <b>DIŞTAN KAPAKLI 100'LÜK PMS 45x45 İÇİN - SİDEM SERİSİ</b> |  |             |             | <b>CE</b> |
| 001 034 100001 00 XX  | 100'LÜK 45X45 PMS TEKLİ SİDEM          | 1           | ad.         | 259,47    |
| 001 034 100002 00 XX  | 100'LÜK 45X45 PMS İKİLİ SİDEM          | 1           | ad.         | 332,24    |
| 001 034 100003 00 XX  | 100'LÜK 45X45 PMS ÜÇLÜ SİDEM           | 1           | ad.         | 473,06    |
| 001 034 100004 00 XX  | 100'LÜK 45X45 PMS DÖRTLÜ SİDEM         | 1           | ad.         | 501,97    |



İÇ KÖŞE



DIŞ KÖŞE



T KÖŞE



L KÖŞE



\*Kutusuz ürünlerde topraklama klemensi bulunmamaktadır.

| Ürün Kodu                        | Ürün Adı                                   | Kutu Adet | Koli Adet | Normal Fiyat (₺) | Kutusuz ve Klemensiz Fiyat (₺) |
|----------------------------------|--|-----------|-----------|------------------|--------------------------------|
| <b>COMFORT W OTOMAT KUTULARI</b> |  |           |           |                  |                                |
| <b>IP40</b>                      |  |           |           |                  |                                |
| 001 057 200001 00 00             | COMFORT MÜHÜRLÜ SİGORTA KUTUSU(S/Ü) 1'Lİ   | 20        | 120       | 48,15            | -                              |
| 001 057 200002 00 00             | COMFORT MÜHÜRLÜ SİGORTA KUTUSU(S/Ü) 1-2'Lİ | 20        | 80        | 53,70            | -                              |
| 001 057 200004 00 00             | COMFORT MÜHÜRLÜ SİGORTA KUTUSU(S/Ü) 2-4'Lİ | 10        | 60        | 77,78            | -                              |
| 001 057 100006 00 00             | COMFORT SİGORTA KUTUSU (S/Ü) 6'Lİ          | 1         | 20        | 407,41           | 334,08                         |
| 001 057 100009 00 00             | COMFORT SİGORTA KUTUSU (S/Ü) 9'LU          | 1         | 20        | 481,48           | 394,81                         |
| 001 057 100012 00 00             | COMFORT SİGORTA KUTUSU (S/Ü) 12'Lİ         | 1         | 10        | 592,59           | 485,92                         |
| 001 057 100018 00 00             | COMFORT SİGORTA KUTUSU (S/Ü) 18'Lİ         | 1         | 10        | 851,85           | 698,52                         |
| 001 057 100024 00 00             | COMFORT SİGORTA KUTUSU (S/Ü) 24'LÜ         | 1         | 5         | 1.037,04         | 819,26                         |
| 001 057 100036 00 00             | COMFORT SİGORTA KUTUSU (S/Ü) 36'Lİ         | 1         | 5         | 1.296,30         | 1.011,11                       |
| 001 057 000006 00 00             | COMFORT SİGORTA KUTUSU (S/A) 6'Lİ          | 1         | 20        | 407,41           | 334,08                         |
| 001 057 000009 00 00             | COMFORT SİGORTA KUTUSU (S/A) 9'LU          | 1         | 20        | 481,48           | 394,81                         |
| 001 057 000012 00 00             | COMFORT SİGORTA KUTUSU (S/A) 12'Lİ         | 1         | 10        | 592,59           | 485,92                         |
| 001 057 000018 00 00             | COMFORT SİGORTA KUTUSU (S/A) 18'Lİ         | 1         | 10        | 851,85           | 698,52                         |
| 001 057 000024 00 00             | COMFORT SİGORTA KUTUSU (S/A) 24'LÜ         | 1         | 5         | 1.037,04         | 819,26                         |
| 001 057 000036 00 00             | COMFORT SİGORTA KUTUSU (S/A) 36'Lİ         | 1         | 5         | 1.296,30         | 1.011,11                       |



| Ürün Kodu  | Ürün Adı  | Kutu Adet | Koli Adet | Fiyat (₺) |
|--|---|-----------|-----------|-----------|
| <b>COMFORT W OTOMAT KUTULARI - ALEV YAYMAYAN</b> |   |           |           |           |
| <b>IP40</b>                                      |   |           |           |           |
| 001 057 210001 00 00                             | COMFORT MÜHÜRLÜ SİGORTA (ALEV YAYMAYAN)(S/Ü) 1'Lİ   | 20        | 120       | 114,81    |
| 001 057 210002 00 00                             | COMFORT MÜHÜRLÜ SİGORTA (ALEV YAYMAYAN)(S/Ü) 1-2'Lİ | 20        | 80        | 135,19    |
| 001 057 210004 00 00                             | COMFORT MÜHÜRLÜ SİGORTA (ALEV YAYMAYAN)(S/Ü) 2-4'LÜ | 10        | 60        | 164,81    |
| 001 057 110006 00 00                             | COMFORT SİGORTA KUTUSU(S/Ü)(ALEV YAYMAYAN) 6'Lİ     | 1         | 20        | 703,70    |
| 001 057 110009 00 00                             | COMFORT SİGORTA KUTUSU(S/Ü)(ALEV YAYMAYAN) 9'LU     | 1         | 20        | 888,89    |
| 001 057 110012 00 00                             | COMFORT SİGORTA KUTUSU(S/Ü)(ALEV YAYMAYAN) 12'Lİ    | 1         | 10        | 1.148,15  |
| 001 057 110018 00 00                             | COMFORT SİGORTA KUTUSU(S/Ü)(ALEV YAYMAYAN) 18'Lİ    | 1         | 10        | 1.629,63  |
| 001 057 110024 00 00                             | COMFORT SİGORTA KUTUSU(S/Ü)(ALEV YAYMAYAN) 24'LÜ    | 1         | 5         | 1.796,30  |
| 001 057 110036 00 00                             | COMFORT SİGORTA KUTUSU(S/Ü)(ALEV YAYMAYAN) 36'Lİ    | 1         | 5         | 2.407,41  |
| 001 057 010006 00 00                             | COMFORT SİGORTA KUTUSU(S/A) ALEV YAYMAYAN 6'Lİ      | 1         | 20        | 703,70    |
| 001 057 010009 00 00                             | COMFORT SİGORTA KUTUSU(S/A) ALEV YAYMAYAN 9'LU      | 1         | 20        | 888,89    |
| 001 057 010012 00 00                             | COMFORT SİGORTA KUTUSU(S/A) ALEV YAYMAYAN 12'Lİ     | 1         | 10        | 1.148,15  |
| 001 057 010018 00 00                             | COMFORT SİGORTA KUTUSU(S/A) ALEV YAYMAYAN 18'Lİ     | 1         | 10        | 1.629,63  |
| 001 057 010024 00 00                             | COMFORT SİGORTA KUTUSU(S/A) ALEV YAYMAYAN 24'LÜ     | 1         | 5         | 1.796,30  |
| 001 057 010036 00 00                             | COMFORT SİGORTA KUTUSU(S/A) ALEV YAYMAYAN 36'Lİ     | 1         | 5         | 2.407,41  |



| Ürün Kodu  | Ürün Adı  | Kutu Adet | Koli Adet | Fiyat (₺) |
|--|---|-----------|-----------|-----------|
| <b>COMFORT W OTOMAT KUTULARI - HALOJEN FREE - ALEV YAYAN</b> |   |           |           |           |
| <b>IP40</b>  |   |           |           |           |
| 001 057 220001 00 00   | COMFORT MÜHÜRLÜ SİGORTA KUTUSU HALOJEN FREE (ALEV YAYAN)(S/Ü)1'Lİ   | 20        | 120       | 62,96     |
| 001 057 220002 00 00   | COMFORT MÜHÜRLÜ SİGORTA KUTUSU HALOJEN FREE (ALEV YAYAN)(S/Ü)1-2'Lİ | 20        | 80        | 81,48     |
| 001 057 220004 00 00   | COMFORT MÜHÜRLÜ SİGORTA KUTUSU HALOJEN FREE (ALEV YAYAN)(S/Ü)2-4'Lİ | 10        | 60        | 103,70    |
| 001 057 120006 00 00   | COMFORT SİGORTA KUTUSU HALOJEN FREE (ALEV YAYAN) (S/Ü) 6'Lİ         | 1         | 20        | 500,00    |
| 001 057 120009 00 00   | COMFORT SİGORTA KUTUSU HALOJEN FREE (ALEV YAYAN) (S/Ü) 9'LU         | 1         | 20        | 592,59    |
| 001 057 120012 00 00   | COMFORT SİGORTA KUTUSU HALOJEN FREE (ALEV YAYAN) (S/Ü) 12'Lİ        | 1         | 10        | 796,30    |
| 001 057 120018 00 00   | COMFORT SİGORTA KUTUSU HALOJEN FREE (ALEV YAYAN) (S/Ü) 18'Lİ        | 1         | 10        | 1.111,11  |
| 001 057 120024 00 00   | COMFORT SİGORTA KUTUSU HALOJEN FREE (ALEV YAYAN) (S/Ü) 24'LÜ        | 1         | 5         | 1.462,96  |
| 001 057 120036 00 00   | COMFORT SİGORTA KUTUSU HALOJEN FREE (ALEV YAYAN) (S/Ü) 36'Lİ        | 1         | 5         | 1.592,59  |
| 001 057 020006 00 00   | COMFORT SİGORTA KUTUSU HALOJEN FREE (ALEV YAYAN) (S/A) 6'Lİ         | 1         | 20        | 500,00    |
| 001 057 020009 00 00   | COMFORT SİGORTA KUTUSU HALOJEN FREE (ALEV YAYAN) (S/A) 9'LU         | 1         | 20        | 592,59    |
| 001 057 020012 00 00   | COMFORT SİGORTA KUTUSU HALOJEN FREE (ALEV YAYAN) (S/A) 12'Lİ        | 1         | 10        | 796,30    |
| 001 057 020018 00 00   | COMFORT SİGORTA KUTUSU HALOJEN FREE (ALEV YAYAN) (S/A) 18'Lİ        | 1         | 10        | 1.111,11  |
| 001 057 020024 00 00   | COMFORT SİGORTA KUTUSU HALOJEN FREE (ALEV YAYAN) (S/A) 24'LÜ        | 1         | 5         | 1.462,96  |
| 001 057 020036 00 00   | COMFORT SİGORTA KUTUSU HALOJEN FREE (ALEV YAYAN) (S/A) 36'Lİ        | 1         | 5         | 1.592,59  |



| Ürün Kodu                                   | Ürün Adı  | Kutu Adet | Koli Adet | Fiyat (₺)   |
|---|---|-----------|-----------|-------------|
| <b>COMFORT W OTOMAT ZAYIF AKIM KUTULARI</b> |   |           |           | <b>IP40</b> |
| 001 057 101012 00 00                        | COMFORT ZAYIF AKIM KUTUSU (S/Ü)(225x270)        | 1         | 10        | 592,59      |
| 001 057 101020 00 00                        | COMFORT ZAYIF AKIM KUTUSU (S/Ü)(270x340)        | 1         | 5         | 1.000,00    |
| 001 057 101024 00 00                        | COMFORT 12'Lİ SİGORTA + ZAYIF AKIM KUTUSU (S/Ü) | 1         | 5         | 1.074,07    |
| 001 057 101036 00 00                        | COMFORT 24'LÜ SİGORTA + ZAYIF AKIM KUTUSU (S/Ü) | 1         | 5         | 1.351,85    |
| 001 057 001012 00 00                        | COMFORT ZAYIF AKIM KUTUSU (S/A)(205x250)        | 1         | 10        | 592,59      |
| 001 057 001020 00 00                        | COMFORT ZAYIF AKIM KUTUSU (S/A)(248x318)        | 1         | 5         | 1.000,00    |
| 001 057 001024 00 00                        | COMFORT 12'Lİ SİGORTA + ZAYIF AKIM KUTUSU (S/A) | 1         | 5         | 1.074,07    |
| 001 057 001036 00 00                        | COMFORT 24'LÜ SİGORTA + ZAYIF AKIM KUTUSU (S/A) | 1         | 5         | 1.351,85    |



| Ürün Kodu   | Ürün Adı  | Kutu Adet | Koli Adet | Fiyat (₺)   |
|---|---|-----------|-----------|-------------|
| <b>COMFORT W OTOMAT ZAYIF AKIM KUTULARI - HALOJEN FREE - ALEV YAYAN</b> |   |           |           | <b>IP40</b> |
| 001 057 121012 00 00  | COMFORT ZAYIF AKIM KUTUSU H.FREE (ALEV YAYAN) (S/Ü)(225x270)        | 1         | 10        | 759,26      |
| 001 057 121020 00 00  | COMFORT ZAYIF AKIM KUTUSU H.FREE (ALEV YAYAN) (S/Ü)(270x340)        | 1         | 5         | 1.240,74    |
| 001 057 121024 00 00  | COMFORT 12'Lİ SİGORTA + ZAYIF AKIM KUTUSU H.FREE (ALEV YAYAN) (S/Ü) | 1         | 5         | 1.351,85    |
| 001 057 121036 00 00  | COMFORT 24'LÜ SİGORTA + ZAYIF AKIM KUTUSU H.FREE (ALEV YAYAN) (S/Ü) | 1         | 5         | 1.629,63    |
| 001 057 021012 00 00  | COMFORT ZAYIF AKIM KUTUSU H.FREE (ALEV YAYAN) (S/A)(205x250)        | 1         | 10        | 759,26      |
| 001 057 021020 00 00  | COMFORT ZAYIF AKIM KUTUSU H.FREE (ALEV YAYAN) (S/A)(248x318)        | 1         | 5         | 1.240,74    |
| 001 057 021024 00 00  | COMFORT 12'Lİ SİGORTA + ZAYIF AKIM KUTUSU H.FREE (ALEV YAYAN) (S/A) | 1         | 5         | 1.351,85    |
| 001 057 021036 00 00  | COMFORT 24'LÜ SİGORTA + ZAYIF AKIM KUTUSU H.FREE (ALEV YAYAN) (S/A) | 1         | 5         | 1.629,63    |

| Ürün Kodu   | Ürün Adı   | Kutu Adet | Koli Adet | Fiyat (₺)   |
|---|--|-----------|-----------|-------------|
| <b>COMFORT W OTOMAT ZAYIF AKIM KUTULARI - ALEV YAYMAYAN</b> |  |           |           | <b>IP40</b> |
| 001 057 111012 00 00  | COMFORT ZAYIF AKIM KUTUSU(A.YAYMAYAN)(S/Ü)(225x270)        | 1         | 10        | 1.018,52    |
| 001 057 111020 00 00  | COMFORT ZAYIF AKIM KUTUSU(A.YAYMAYAN)(S/Ü)(270x340)        | 1         | 5         | 1.629,63    |
| 001 057 111024 00 00  | COMFORT 12'Lİ SİGORTA + ZAYIF AKIM KUTUSU(A.YAYMAYAN)(S/Ü) | 1         | 5         | 1.629,63    |
| 001 057 111036 00 00  | COMFORT 24'LÜ SİGORTA + ZAYIF AKIM KUTUSU(A.YAYMAYAN)(S/Ü) | 1         | 5         | 2.037,04    |
| 001 057 011012 00 00  | COMFORT ZAYIF AKIM KUTUSU(A.YAYMAYAN)(S/A)(205x250)        | 1         | 10        | 1.018,52    |
| 001 057 011020 00 00  | COMFORT ZAYIF AKIM KUTUSU(A.YAYMAYAN)(S/A)(248x318)        | 1         | 5         | 1.629,63    |
| 001 057 011024 00 00  | COMFORT 12'Lİ SİGORTA + ZAYIF AKIM KUTUSU(A.YAYMAYAN)(S/A) | 1         | 5         | 1.629,63    |
| 001 057 011036 00 00  | COMFORT 24'LÜ SİGORTA + ZAYIF AKIM KUTUSU(A.YAYMAYAN)(S/A) | 1         | 5         | 2.037,04    |



Sıva altı serisinde **betopan**, **alçıpan** duvarlara montaj yapılabileme özelliği.



| Ürün Kodu                                   | Ürün Adı                              | Kutu Adet | Koli Adet | Fiyat (₺) |
|---|---------------------------------------|-----------|-----------|-----------|
| <b>COMFORT W OTOMAT KUTUSU AKSESUARLARI</b> |                                       |           |           |           |
| 001 057 990001 00 00                        | SIVA ALTI COMFORT ALÇIPAN MONTAJ SETİ | 1         |           | 62,96     |
| 001 057 990002 00 00                        | COMFORT SU TERAZİSİ                   | 1         |           | 111,11    |
| 000 700 000574 00 00                        | RAY YÜKSELTME PARÇASI (UZUN/KISA)     | 1         |           | 11,11     |
| 001 057 001236 00 00                        | COMFORT ZAYIF AKIM ÖRTME PARÇASI      | 50        |           | 62,96     |

| Ürün Kodu                     | Ürün Adı                     | Kutu Adet | Koli Adet | Fiyat (₺) |
|-------------------------------|------------------------------|-----------|-----------|-----------|
| <b>W OTOMAT ÖRTME PARÇASI</b> |                              |           |           |           |
| 001 026 000002 00 00          | W OTOMAT ÖRTME PARÇASI 12'Lİ | 50        | 400       | 37,04     |





| Ürün Kodu  | Ürün Adı   | Kutu Adet | Koli Adet | Kutu Fiyat (₺)  |
|--|--|-----------|-----------|-----------------|
| <b>MEKSBOX W OTOMAT KUTULARI</b>                 |  |           |           | <b>IP30</b>     |
| 001 027 200001 00 00                             | MÜHÜRLÜ W OTOMAT KUTUSU (S/Ü) 1'Lİ               | 20        | 160       | <b>44,44</b>    |
| 001 027 200002 00 00                             | MÜHÜRLÜ W OTOMAT KUTUSU (S/Ü) 2'Lİ               | 20        | 80        | <b>51,85</b>    |
| 001 027 200004 00 00                             | MÜHÜRLÜ W OTOMAT KUTUSU (S/Ü) 4'LÜ               | 10        | 80        | <b>74,07</b>    |
| 001 027 100002 00 00                             | W OTOMAT KUTUSU (S/Ü) MEKSBOX 2'Lİ               | 1         | 30        | <b>370,37</b>   |
| 001 027 000002 00 00                             | W OTOMAT KUTUSU (S/A) MEKSBOX 2'Lİ               | 1         | 30        | <b>370,37</b>   |
| 001 027 100004 00 00                             | W OTOMAT KUTUSU (S/Ü) MEKSBOX 4'LÜ               | 1         | 20        | <b>377,78</b>   |
| 001 027 000004 00 00                             | W OTOMAT KUTUSU (S/A) MEKSBOX 4'LÜ               | 1         | 20        | <b>377,78</b>   |
| 001 027 100006 00 00                             | W OTOMAT KUTUSU (S/Ü) MEKSBOX 6'Lİ               | 1         | 20        | <b>388,89</b>   |
| 001 027 000006 00 00                             | W OTOMAT KUTUSU (S/A) MEKSBOX 6'Lİ               | 1         | 20        | <b>388,89</b>   |
| 001 027 100009 00 00                             | W OTOMAT KUTUSU (S/Ü) MEKSBOX 9'LU               | 1         | 20        | <b>481,48</b>   |
| 001 027 000009 00 00                             | W OTOMAT KUTUSU (S/A) MEKSBOX 9'LU               | 1         | 20        | <b>481,48</b>   |
| 001 027 100012 00 00                             | W OTOMAT KUTUSU (S/Ü) MEKSBOX 12'Lİ              | 1         | 10        | <b>577,78</b>   |
| 001 027 000012 00 00                             | W OTOMAT KUTUSU (S/A) MEKSBOX 12'Lİ              | 1         | 10        | <b>577,78</b>   |
| 001 027 100016 00 00                             | W OTOMAT KUTUSU (S/Ü) MEKSBOX 16'Lİ              | 1         | 10        | <b>833,33</b>   |
| 001 027 000016 00 00                             | W OTOMAT KUTUSU (S/A) MEKSBOX 16'Lİ              | 1         | 10        | <b>833,33</b>   |
| 001 027 100024 00 00                             | W OTOMAT KUTUSU (S/Ü) MEKSBOX 24'LÜ              | 1         | 5         | <b>1.018,52</b> |
| 001 027 000024 00 00                             | W OTOMAT KUTUSU (S/A) MEKSBOX 24'LÜ              | 1         | 5         | <b>1.018,52</b> |
| 001 027 100036 00 00                             | W OTOMAT KUTUSU (S/Ü) MEKSBOX 36'Lİ              | 1         | 5         | <b>1.277,78</b> |
| 001 027 000036 00 00                             | W OTOMAT KUTUSU (S/A) MEKSBOX 36'Lİ              | 1         | 5         | <b>1.277,78</b> |
| <b>MEKSBOX W OTOMAT KUTULARI - ALEV YAYMAYAN</b> |  |           |           | <b>IP30</b>     |
| 001 027 210001 00 00                             | MÜHÜRLÜ W OTOMAT KUTUSU ALEV YAYMAYAN (S/Ü) 1'Lİ | 20        | 160       | <b>103,70</b>   |
| 001 027 210002 00 00                             | MÜHÜRLÜ W OTOMAT KUTUSU ALEV YAYMAYAN (S/Ü) 2'Lİ | 20        | 80        | <b>122,22</b>   |
| 001 027 210004 00 00                             | MÜHÜRLÜ W OTOMAT KUTUSU ALEV YAYMAYAN (S/Ü) 4'LÜ | 10        | 80        | <b>148,15</b>   |
| 001 027 110002 00 00                             | W OTOMAT KUTUSU (S/Ü) ALEV YAYMAYAN 2'Lİ         | 1         | 30        | <b>629,63</b>   |
| 001 027 010002 00 00                             | W OTOMAT KUTUSU (S/A) ALEV YAYMAYAN 2'Lİ         | 1         | 30        | <b>629,63</b>   |
| 001 027 110004 00 00                             | W OTOMAT KUTUSU (S/Ü) ALEV YAYMAYAN 4'LÜ         | 1         | 20        | <b>648,15</b>   |
| 001 027 010004 00 00                             | W OTOMAT KUTUSU (S/A) ALEV YAYMAYAN 4'LÜ         | 1         | 20        | <b>648,15</b>   |
| 001 027 110006 00 00                             | W OTOMAT KUTUSU (S/Ü) ALEV YAYMAYAN 6'Lİ         | 1         | 20        | <b>685,19</b>   |
| 001 027 010006 00 00                             | W OTOMAT KUTUSU (S/A) ALEV YAYMAYAN 6'Lİ         | 1         | 20        | <b>685,19</b>   |
| 001 027 110009 00 00                             | W OTOMAT KUTUSU (S/Ü) ALEV YAYMAYAN 9'LU         | 1         | 20        | <b>870,37</b>   |
| 001 027 010009 00 00                             | W OTOMAT KUTUSU (S/A) ALEV YAYMAYAN 9'LU         | 1         | 20        | <b>870,37</b>   |
| 001 027 110012 00 00                             | W OTOMAT KUTUSU (S/Ü) ALEV YAYMAYAN 12'Lİ        | 1         | 10        | <b>1.129,63</b> |
| 001 027 010012 00 00                             | W OTOMAT KUTUSU (S/A) ALEV YAYMAYAN 12'Lİ        | 1         | 10        | <b>1.129,63</b> |
| 001 027 110016 00 00                             | W OTOMAT KUTUSU (S/Ü) ALEV YAYMAYAN 16'Lİ        | 1         | 10        | <b>1.333,33</b> |
| 001 027 010016 00 00                             | W OTOMAT KUTUSU (S/A) ALEV YAYMAYAN 16'Lİ        | 1         | 10        | <b>1.333,33</b> |
| 001 027 110024 00 00                             | W OTOMAT KUTUSU (S/Ü) ALEV YAYMAYAN 24'LÜ        | 1         | 5         | <b>1.777,78</b> |
| 001 027 010024 00 00                             | W OTOMAT KUTUSU (S/A) ALEV YAYMAYAN 24'LÜ        | 1         | 5         | <b>1.777,78</b> |
| 001 027 110036 00 00                             | W OTOMAT KUTUSU (S/Ü) ALEV YAYMAYAN 36'Lİ        | 1         | 5         | <b>2.314,81</b> |
| 001 027 010036 00 00                             | W OTOMAT KUTUSU (S/A) ALEV YAYMAYAN 36'Lİ        | 1         | 5         | <b>2.314,81</b> |

| Ürün Kodu  | Ürün Adı                                  | Ort. İç Çap | Ort. Dış Çap | Kutu Mt. | Koli Adet | Fiyat (₺) |
|--|---|-------------|--------------|----------|-----------|-----------|
| <b>HAFİF SERİ PVC SİRALLER - ALEV YAYMAYAN (320N)</b>              |   |             |              |          |           |           |
| 001 020 010016 00 17   | Ø16 ALEV YAYMAYAN SİRAL (HAFİF SERİ)      | 11,4        | 15,85        | 100 mt.  | 500       | 16,83     |
| 001 020 010020 00 17   | Ø20 ALEV YAYMAYAN SİRAL (HAFİF SERİ)      | 14,5        | 19,85        | 100 mt.  | 500       | 22,20     |
| 001 020 010025 00 17   | Ø25 ALEV YAYMAYAN SİRAL (HAFİF SERİ)      | 18,7        | 24,8         | 50 mt.   | 250       | 31,50     |
| 001 020 010032 00 17   | Ø32 ALEV YAYMAYAN SİRAL (HAFİF SERİ)      | 24,9        | 31,8         | 50 mt.   | 250       | 39,11     |
| <b>AĞIR SERİ PVC SİRALLER -ALEV YAYMAYAN (750N)</b>                |   |             |              |          |           |           |
| 001 020 000016 00 17   | Ø16 ALEV YAYMAYAN SİRAL (AĞIR SERİ)       | 11,2        | 15,85        | 100 mt.  | 500       | 19,25     |
| 001 020 000020 00 17   | Ø20 ALEV YAYMAYAN SİRAL (AĞIR SERİ)       | 14,4        | 19,85        | 100 mt.  | 500       | 24,45     |
| 001 020 000025 00 17   | Ø25 ALEV YAYMAYAN SİRAL (AĞIR SERİ)       | 18,1        | 24,8         | 50 mt.   | 250       | 33,00     |
| 001 020 000032 00 17   | Ø32 ALEV YAYMAYAN SİRAL (AĞIR SERİ)       | 24,7        | 31,8         | 50 mt.   | 250       | 40,06     |
| <b>HAFİF SERİ PVC TELLİ SİRALLER - ALEV YAYMAYAN (320N)</b>        |   |             |              |          |           |           |
| 001 020 120016 00 17   | Ø16 TELLİ ALEV YAYMAYAN (HAFİF SERİ)      | 11,4        | 15,85        | 100 mt.  | 500       | 20,45     |
| 001 020 120020 00 17   | Ø20 TELLİ ALEV YAYMAYAN (HAFİF SERİ)      | 14,5        | 19,85        | 100 mt.  | 500       | 25,92     |
| 001 020 120025 00 17   | Ø25 TELLİ ALEV YAYMAYAN (HAFİF SERİ)      | 18,7        | 24,8         | 50 mt.   | 250       | 35,17     |
| 001 020 120032 00 17   | Ø32 TELLİ ALEV YAYMAYAN (HAFİF SERİ)      | 24,9        | 31,8         | 50 mt.   | 250       | 43,21     |
| <b>AĞIR SERİ PVC TELLİ SİRALLER - ALEV YAYMAYAN (750N)</b>         |   |             |              |          |           |           |
| 001 020 100016 00 17   | Ø16 TELLİ ALEV YAYMAYAN (AĞIR SERİ)       | 11,2        | 15,85        | 100 mt.  | 500       | 22,91     |
| 001 020 100020 00 17   | Ø20 TELLİ ALEV YAYMAYAN (AĞIR SERİ)       | 14,4        | 19,85        | 100 mt.  | 500       | 28,30     |
| 001 020 100025 00 17   | Ø25 TELLİ ALEV YAYMAYAN (AĞIR SERİ)       | 18,1        | 24,8         | 50 mt.   | 250       | 36,91     |
| 001 020 100032 00 17   | Ø32 TELLİ ALEV YAYMAYAN (AĞIR SERİ)       | 24,7        | 31,8         | 50 mt.   | 250       | 44,14     |
| <b>HALOJEN FREE SİRALLER -ALEV YAYAN (320N)</b>                   |   |             |              |          |           |           |
| 001 020 140016 00 17   | Ø16 HALOJEN FREE SİRAL (ALEV YAYAN)       | 11,2        | 15,7         | 100 mt.  | 500       | 12,43     |
| 001 020 140020 00 17   | Ø20 HALOJEN FREE SİRAL (ALEV YAYAN)       | 14,4        | 19,85        | 100 mt.  | 500       | 15,00     |
| 001 020 140025 00 17   | Ø25 HALOJEN FREE SİRAL (ALEV YAYAN)       | 19,1        | 24,7         | 50 mt.   | 250       | 21,91     |
| 001 020 140032 00 17   | Ø32 HALOJEN FREE SİRAL (ALEV YAYAN)       | 24,85       | 31,6         | 50 mt.   | 250       | 26,68     |
| 001 020 140040 00 17   | Ø40 HALOJEN FREE SİRAL (ALEV YAYAN)       |             |              | 25 mt.   | 125       | 47,14     |
| 001 020 140050 00 17   | Ø50 HALOJEN FREE SİRAL (ALEV YAYAN)       |             |              | 25 mt.   | 125       | 56,70     |
| <b>HALOJEN FREE SİRALLER -ALEV YAYAN (750N)</b>             |   |             |              |          |           |           |
| 001 020 740020 00 17   | Ø20 HALOJEN FREE SİRAL (ALEV YAYAN)       | 14,4        | 19,85        | 100 mt.  | 500       | 32,70     |
| 001 020 740025 00 17   | Ø25 HALOJEN FREE SİRAL (ALEV YAYAN)       | 18,7        | 24,7         | 50 mt.   | 250       | 44,85     |
| 001 020 740032 00 17   | Ø32 HALOJEN FREE SİRAL (ALEV YAYAN)       | 24,2        | 31,6         | 50 mt.   | 250       | 62,13     |
| <b>HALOJEN FREE SİRALLER TELLİ - ALEV YAYAN (320N)</b>      |   |             |              |          |           |           |
| 001 020 141016 00 17   | Ø16 HALOJEN FREE SİRAL(ALEV YAYAN)(TELLİ) | 11,2        | 15,7         | 100 mt.  | 500       | 14,46     |
| 001 020 141020 00 17   | Ø20 HALOJEN FREE SİRAL(ALEV YAYAN)(TELLİ) | 14,4        | 19,85        | 100 mt.  | 500       | 17,03     |
| 001 020 141025 00 17   | Ø25 HALOJEN FREE SİRAL(ALEV YAYAN)(TELLİ) | 19,1        | 24,7         | 50 mt.   | 250       | 23,94     |
| 001 020 141032 00 17   | Ø32 HALOJEN FREE SİRAL(ALEV YAYAN)(TELLİ) | 24,85       | 31,6         | 50 mt.   | 250       | 28,71     |
| 001 020 141040 00 17   | Ø40 HALOJEN FREE SİRAL(ALEV YAYAN)(TELLİ) |             |              | 25 mt.   | 125       | 48,90     |
| <b>HALOJEN FREE SİRALLER - ALEV YAYMAYAN (320N)</b>          |   |             |              |          |           |           |
| 001 020 150016 00 17   | Ø16 HALOJEN FREE SİRAL(ALEV YAYMAYAN)     | 11,2        | 15,7         | 100 mt.  | 500       | 18,81     |
| 001 020 150020 00 17   | Ø20 HALOJEN FREE SİRAL(ALEV YAYMAYAN)     | 14,4        | 19,85        | 100 mt.  | 500       | 23,74     |
| 001 020 150025 00 17   | Ø25 HALOJEN FREE SİRAL(ALEV YAYMAYAN)     | 19,1        | 24,7         | 50 mt.   | 250       | 34,43     |
| 001 020 150032 00 17   | Ø32 HALOJEN FREE SİRAL(ALEV YAYMAYAN)     | 24,85       | 31,6         | 50 mt.   | 250       | 42,03     |
| 001 020 150040 00 17   | Ø40 HALOJEN FREE SİRAL(ALEV YAYMAYAN)     |             |              | 25 mt.   | 125       | 74,30     |
| 001 020 150050 00 17   | Ø50 HALOJEN FREE SİRAL(ALEV YAYMAYAN)     |             |              | 25 mt.   | 125       | 90,23     |
| <b>HALOJEN FREE SİRALLER - ALEV YAYMAYAN (750N)</b>          |   |             |              |          |           |           |
| 001 020 750020 00 17   | Ø20 HALOJEN FREE SİRAL (ALEV YAYMAYAN)    | 14,4        | 19,85        | 100 mt.  | 500       | 48,12     |
| 001 020 750025 00 17   | Ø25 HALOJEN FREE SİRAL (ALEV YAYMAYAN)    | 18,7        | 24,7         | 50 mt.   | 250       | 67,77     |
| 001 020 750032 00 17   | Ø32 HALOJEN FREE SİRAL (ALEV YAYMAYAN)    | 24,2        | 31,6         | 50 mt.   | 250       | 89,41     |
| <b>HALOJEN FREE SİRALLER TELLİ - ALEV YAYMAYAN (320N)</b>    |   |             |              |          |           |           |
| 001 020 151016 00 17   | Ø16 HALOJEN SİRAL(ALEV YAYMAYAN)(TELLİ)   | 11,2        | 15,7         | 100 mt.  | 500       | 22,76     |
| 001 020 151020 00 17   | Ø20 HALOJEN SİRAL(ALEV YAYMAYAN)(TELLİ)   | 14,4        | 19,85        | 100 mt.  | 500       | 26,92     |
| 001 020 151025 00 17   | Ø25 HALOJEN SİRAL(ALEV YAYMAYAN)(TELLİ)   | 19,1        | 24,7         | 50 mt.   | 250       | 36,93     |
| 001 020 151032 00 17   | Ø32 HALOJEN SİRAL(ALEV YAYMAYAN)(TELLİ)   | 24,85       | 31,6         | 50 mt.   | 250       | 43,57     |
| 001 020 151040 00 17   | Ø40 HALOJEN SİRAL(ALEV YAYMAYAN)(TELLİ)   |             |              | 25 mt.   | 125       | 73,92     |





| Ürün Kodu | Ürün Adı | Ort. İç Çap | Ort. Dış Çap | Kutu m/Ad. | Koli Adet | Fiyat (₺) |
|-----------|----------|-------------|--------------|------------|-----------|-----------|
|-----------|----------|-------------|--------------|------------|-----------|-----------|

**MEKS SERİSİ PLASTİK SİRALLER - SİYAH**

|                      |                              |       |       |       |      |       |
|----------------------|------------------------------|-------|-------|-------|------|-------|
| 001 020 400012 00 11 | Ø12 PLASTİK SİRALLER (SİYAH) | 12,3  | 15,9  | 100 m | 1000 | 10,12 |
| 001 020 400014 00 11 | Ø14 PLASTİK SİRALLER (SİYAH) | 15,25 | 18,75 | 100 m | 1000 | 10,37 |
| 001 020 400016 00 11 | Ø16 PLASTİK SİRALLER (SİYAH) | 15,7  | 19    | 100 m | 1000 | 10,37 |
| 001 020 400018 00 11 | Ø18 PLASTİK SİRALLER (SİYAH) | 19,6  | 24,03 | 100 m | 500  | 15,20 |
| 001 020 400020 00 11 | Ø20 PLASTİK SİRALLER (SİYAH) | 19,6  | 24,03 | 100 m | 500  | 15,20 |
| 001 020 400026 00 11 | Ø26 PLASTİK SİRALLER (SİYAH) | 26,15 | 30,75 | 50 m  | 250  | 22,65 |
| 001 020 400032 00 11 | Ø32 PLASTİK SİRALLER (SİYAH) | 29,1  | 34,3  | 50 m  | 250  | 26,29 |
| 001 020 400040 00 11 | Ø40 PLASTİK SİRALLER (SİYAH) | 36,2  | 42,2  | 25 m  | 125  | 41,45 |
| 001 020 400050 00 11 | Ø50 PLASTİK SİRALLER (SİYAH) | 48,5  | 54,5  | 25 m  | 125  | 49,39 |

**MEKS SERİSİ PLASTİK SİRALLER - SİYAH - TELLİ**

|                      |                                    |       |       |       |      |       |
|----------------------|------------------------------------|-------|-------|-------|------|-------|
| 001 020 410014 00 11 | Ø14 PLASTİK SİRALLER (SİYAH) TELLİ | 15,25 | 18,75 | 100 m | 1000 | 13,22 |
| 001 020 410016 00 11 | Ø16 PLASTİK SİRALLER (SİYAH) TELLİ | 15,7  | 19    | 100 m | 1000 | 13,22 |
| 001 020 410018 00 11 | Ø18 PLASTİK SİRALLER (SİYAH) TELLİ | 19,6  | 24,03 | 100 m | 500  | 17,37 |
| 001 020 410020 00 11 | Ø20 PLASTİK SİRALLER (SİYAH) TELLİ | 19,6  | 24,03 | 100 m | 500  | 17,37 |
| 001 020 410026 00 11 | Ø26 PLASTİK SİRALLER (SİYAH) TELLİ | 26,15 | 30,75 | 50 m  | 250  | 24,96 |
| 001 020 410032 00 11 | Ø32 PLASTİK SİRALLER (SİYAH) TELLİ | 29,1  | 34,3  | 50 m  | 250  | 28,48 |
| 001 020 410040 00 11 | Ø40 PLASTİK SİRALLER (SİYAH) TELLİ | 36,2  | 42,2  | 25 m  | 125  | 43,71 |

| Ürün Kodu | Ürün Adı | Ort. İç Çap | Ort. Dış Çap | Kutu m/Ad. | Koli Adet | Gri Fiyat (₺) | Beyaz Fiyat (₺) |
|-----------|----------|-------------|--------------|------------|-----------|---------------|-----------------|
|-----------|----------|-------------|--------------|------------|-----------|---------------|-----------------|

**PLASTİK SİRALLER - GRİ/BEYAZ**

|                      |                               |       |       |       |      |       |       |
|----------------------|-------------------------------|-------|-------|-------|------|-------|-------|
| 001 020 400014 00 XX | Ø14 PLASTİK SİRAL (GRİ-BEYAZ) | 15,25 | 18,75 | 100 m | 1000 | 11,87 | 13,48 |
| 001 020 400016 00 XX | Ø16 PLASTİK SİRAL (GRİ-BEYAZ) | 15,7  | 19    | 100 m | 1000 | 13,48 | 13,48 |
| 001 020 400018 00 XX | Ø18 PLASTİK SİRAL (GRİ-BEYAZ) | 19,6  | 24,03 | 100 m | 500  | 17,70 | 22,64 |
| 001 020 400020 00 XX | Ø20 PLASTİK SİRAL (GRİ-BEYAZ) | 19,6  | 24,03 | 100 m | 500  | 17,70 | 22,64 |
| 001 020 400026 00 XX | Ø26 PLASTİK SİRAL (GRİ-BEYAZ) | 26,15 | 30,75 | 50 m  | 250  | 26,41 | 30,17 |
| 001 020 400032 00 XX | Ø32 PLASTİK SİRAL (GRİ-BEYAZ) | 29,1  | 34,3  | 50 m  | 250  | 30,59 | 34,93 |
| 001 020 400040 00 XX | Ø40 PLASTİK SİRAL (GRİ-BEYAZ) | 36,2  | 42,2  | 25 m  | 125  | 48,46 | 55,41 |
| 001 020 400050 00 XX | Ø50 PLASTİK SİRAL (GRİ-BEYAZ) | 48,5  | 54,5  | 25 m  | 125  | 56,63 | 74,74 |

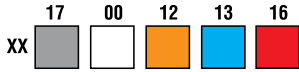

| Ürün Kodu | Ürün Adı | Ort. İç Çap | Ort. Dış Çap | Kutu m /Ad. | Koli Adet | Renkli Fiyat (₺) |
|-----------|----------|-------------|--------------|-------------|-----------|------------------|
|-----------|----------|-------------|--------------|-------------|-----------|------------------|

**PLASTİK SİRALLER - RENKLİ (KIRMIZI-TURUNCU-MAVİ)**

|                      |  |       |       |       |      |       |
|----------------------|--|-------|-------|-------|------|-------|
| 001 020 400014 00 XX | Ø14 PLASTİK SİRAL (KIRMIZI-TURUNCU-MAVİ) | 15,25 | 18,75 | 100 m | 1000 | 11,87 |
| 001 020 400016 00 XX | Ø16 PLASTİK SİRAL (KIRMIZI-TURUNCU-MAVİ) | 15,7  | 19    | 100 m | 1000 | 11,90 |
| 001 020 400018 00 XX | Ø18 PLASTİK SİRAL (KIRMIZI-TURUNCU-MAVİ) | 19,6  | 24,03 | 100 m | 500  | 17,71 |
| 001 020 400020 00 XX | Ø20 PLASTİK SİRAL (KIRMIZI-TURUNCU-MAVİ) | 19,6  | 24,03 | 100 m | 500  | 17,64 |
| 001 020 400026 00 XX | Ø26 PLASTİK SİRAL (KIRMIZI-TURUNCU-MAVİ) | 26,15 | 30,75 | 50 m  | 250  | 26,41 |
| 001 020 400032 00 XX | Ø32 PLASTİK SİRAL (KIRMIZI-TURUNCU-MAVİ) | 29,1  | 34,3  | 50 m  | 250  | 30,59 |
| 001 020 400040 00 XX | Ø40 PLASTİK SİRAL (KIRMIZI-TURUNCU-MAVİ) | 36,2  | 42,2  | 25 m  | 125  | 48,46 |
| 001 020 400050 00 XX | Ø50 PLASTİK SİRAL (KIRMIZI-TURUNCU-MAVİ) | 48,5  | 54,5  | 25 m  | 125  | 56,63 |

**SİRAL EK MUFLARI - GRİ**

|                      |                           |  |  |         |  |       |
|----------------------|---------------------------|--|--|---------|--|-------|
| 001 020 990016 00 17 | 16 mm SİRAL EK MUFU (GRİ) |  |  | 200 ad. |  | 13,89 |
| 001 020 990020 00 17 | 20 mm SİRAL EK MUFU (GRİ) |  |  | 200 ad. |  | 16,67 |
| 001 020 990025 00 17 | 25 mm SİRAL EK MUFU (GRİ) |  |  | 100 ad. |  | 20,74 |
| 001 020 990032 00 17 | 32 mm SİRAL EK MUFU (GRİ) |  |  | 200 ad. |  | 27,78 |

| Ürün Kodu | Ürün Adı | Ortalama İç Çap | Ortalama Dış Çap | Kutu Metre/Ad. | Fiyat (₺) |
|-----------|----------|-----------------|------------------|----------------|-----------|
|-----------|----------|-----------------|------------------|----------------|-----------|

**KORUGE BORULAR (250N)**

|                |                            |     |     |       |        |
|----------------|----------------------------|-----|-----|-------|--------|
| 096 045 150050 | Ø50 KORUGE KANGAL BORU     | 43  | 50  | 100 m | 83,03  |
| 096 045 150060 | Ø63 KORUGE KANGAL BORU     | 54  | 63  | 100 m | 103,78 |
| 096 045 150075 | Ø75 KORUGE KANGAL BORU     | 64  | 75  | 100 m | 124,54 |
| 096 045 150100 | Ø100 KORUGE BOY BORU (6 m) | 87  | 100 | 6 m   | 151,81 |
| 096 045 150115 | Ø115 KORUGE BOY BORU (6 m) | 100 | 115 | 6 m   | 166,06 |
| 096 045 150004 | Ø50 MANŞON                 |     |     | 1 ad. | 35,58  |
| 096 045 150003 | Ø75 MANŞON                 |     |     | 1 ad. | 45,99  |
| 096 045 150002 | Ø100 MANŞON                |     |     | 1 ad. | 53,38  |
| 096 045 150001 | Ø115 MANŞON                |     |     | 1 ad. | 65,24  |

**RÖGAR KUTUSU**

|                |                          |  |  |       |          |
|----------------|--------------------------|--|--|-------|----------|
| 074 048 622020 | 20X20 RÖGAR KUTUSU TAKIM |  |  | 1 ad. | 300,93   |
| 074 048 623030 | 30X30 RÖGAR KUTUSU TAKIM |  |  | 1 ad. | 740,74   |
| 074 048 624040 | 40X40 RÖGAR KUTUSU TAKIM |  |  | 1 ad. | 1.527,78 |
| 074 048 625555 | 55X55 RÖGAR KUTUSU TAKIM |  |  | 1 ad. | 3.333,33 |



| Ürün Kodu  | Ürün Adı                        | Ort. İç Çap | Ort. Dış Çap | Kutu Metre | Koli Adet | Fiyat (₺) |
|--|---------------------------------|-------------|--------------|------------|-----------|-----------|
| <b>EKO SERİSİ ÇELİK SİRALLER</b>  |                                 |             |              |            |           |           |
| 001 054 150009 00 66   | Ø9 EKO ÇELİK SİRALLER           | 9           | 12,1         | 50 m       | 200       | 32,34     |
| 001 054 150011 00 66   | Ø11 EKO ÇELİK SİRALLER (3/8")   | 11          | 14,1         | 50 m       | 200       | 33,12     |
| 001 054 150014 00 66   | Ø14 EKO ÇELİK SİRALLER (1/2")   | 14          | 17,1         | 50 m       | 200       | 39,86     |
| 001 054 150016 00 66   | Ø16 EKO ÇELİK SİRALLER          | 16          | 19,1         | 50 m       | 200       | 43,81     |
| 001 054 150018 00 66   | Ø18 EKO ÇELİK SİRALLER          | 18          | 21,1         | 50 m       | 200       | 47,99     |
| 001 054 150021 00 66   | Ø21 EKO ÇELİK SİRALLER (3/4")   | 21          | 24,1         | 50 m       | 200       | 53,51     |
| 001 054 150026 00 66   | Ø26 EKO ÇELİK SİRALLER (1")     | 26          | 29,1         | 25 m       | 100       | 73,08     |
| 001 054 150029 00 66   | Ø29 EKO ÇELİK SİRALLER (1 1/4") | 29          | 32,1         | 25 m       | 100       | 78,99     |
| 001 054 150032 00 66   | Ø32 EKO ÇELİK SİRALLER          | 32          | 35,1         | 25 m       | 100       | 84,35     |
| 001 054 150037 00 66   | Ø37 EKO ÇELİK SİRALLER (1 1/2") | 37          | 41,1         | 25 m       | 100       | 110,84    |
| 001 054 150042 00 66   | Ø42 EKO ÇELİK SİRALLER          | 42          | 45,1         | 25 m       | 100       | 129,14    |
| 001 054 150050 00 66   | Ø50 EKO ÇELİK SİRALLER (2")     | 50          | 53,1         | 25 m       | 100       | 179,27    |
| 001 054 150063 00 66   | Ø63 EKO ÇELİK SİRALLER          | 63          | 66,1         | 15 m       | 60        | 243,85    |



|  |                                     |    |      |      |     |        |
|--|-------------------------------------|----|------|------|-----|--------|
| <b>EKO SERİSİ ÇELİK SİRALLER - KILAVUZ TELLİ</b>  |                                     |    |      |      |     |        |
| 001 054 221011 00 66   | Ø11 EKO ÇELİK SİRAL (TELLİ)(3/8")   | 11 | 14,1 | 50 m | 200 | 38,71  |
| 001 054 221014 00 66   | Ø14 EKO ÇELİK SİRAL (TELLİ)(1/2")   | 14 | 17,1 | 50 m | 200 | 46,98  |
| 001 054 221016 00 66   | Ø16 EKO ÇELİK SİRAL (TELLİ)         | 16 | 19,1 | 50 m | 200 | 49,74  |
| 001 054 221018 00 66   | Ø18 EKO ÇELİK SİRAL (TELLİ)         | 18 | 21,1 | 50 m | 200 | 57,90  |
| 001 054 221021 00 66   | Ø21 EKO ÇELİK SİRAL (TELLİ) (3/4")  | 21 | 24,1 | 50 m | 200 | 59,69  |
| 001 054 221026 00 66   | Ø26 EKO ÇELİK SİRAL (TELLİ)(1")     | 26 | 29,1 | 25 m | 100 | 80,54  |
| 001 054 221029 00 66   | Ø29 EKO ÇELİK SİRAL (TELLİ)(1 1/4") | 29 | 32,1 | 25 m | 100 | 84,86  |
| 001 054 221032 00 66   | Ø32 EKO ÇELİK SİRAL (TELLİ)         | 32 | 35,1 | 25 m | 100 | 97,24  |
| 001 054 221037 00 66   | Ø37 EKO ÇELİK SİRAL (TELLİ)(1 1/2") | 37 | 41,1 | 25 m | 100 | 117,90 |
| 001 054 221042 00 66   | Ø42 EKO ÇELİK SİRAL (TELLİ)         | 42 | 45,1 | 25 m | 100 | 136,03 |
| 001 054 221050 00 66   | Ø50 EKO ÇELİK SİRAL (TELLİ) (2")    | 50 | 53,1 | 25 m | 100 | 186,29 |
| 001 054 221063 00 66   | Ø63 EKO ÇELİK SİRALLER              | 63 | 66,1 | 15 m | 60  | 254,66 |



|  |                                      |    |      |      |  |        |
|--|--------------------------------------|----|------|------|--|--------|
| <b>EKO SERİSİ İZOLELİ ÇELİK SİRALLER</b>  |                                      |    |      |      |  |        |
| 001 054 160009 00 11   | Ø9 EKO İZOLELİ ÇELİK SİRAL           | 9  | 13,2 | 50 m |  | 40,69  |
| 001 054 160011 00 11   | Ø11 EKO İZOLELİ ÇELİK SİRAL(3/8")    | 11 | 15,2 | 50 m |  | 41,93  |
| 001 054 160014 00 11   | Ø14 EKO İZOLELİ ÇELİK SİRAL(1/2")    | 14 | 18,4 | 50 m |  | 49,87  |
| 001 054 160016 00 11   | Ø16 EKO İZOLELİ ÇELİK SİRAL          | 16 | 20,4 | 50 m |  | 52,89  |
| 001 054 160018 00 11   | Ø18 EKO İZOLELİ ÇELİK SİRAL          | 18 | 22,4 | 50 m |  | 61,08  |
| 001 054 160021 00 11   | Ø21 EKO İZOLELİ ÇELİK SİRAL (3/4")   | 21 | 25,4 | 50 m |  | 72,61  |
| 001 054 160026 00 11   | Ø26 EKO İZOLELİ ÇELİK SİRAL(1")      | 26 | 30,4 | 25 m |  | 89,08  |
| 001 054 160029 00 11   | Ø29 EKO İZOLELİ ÇELİK SİRAL(1 1/4")  | 29 | 33,4 | 25 m |  | 97,22  |
| 001 054 160032 00 11   | Ø32 EKO İZOLELİ ÇELİK SİRAL          | 32 | 36,4 | 25 m |  | 111,11 |
| 001 054 160037 00 11   | Ø37 EKO İZOLELİ ÇELİK SİRAL (1 1/2") | 37 | 42,4 | 25 m |  | 138,52 |
| 001 054 160042 00 11   | Ø42 EKO İZOLELİ ÇELİK SİRAL          | 42 | 46,4 | 25 m |  | 167,96 |
| 001 054 160050 00 11   | Ø50 EKO İZOLELİ ÇELİK SİRAL(2")      | 50 | 54,4 | 25 m |  | 225,16 |
| 001 054 160063 00 11   | Ø63 EKO İZOLELİ ÇELİK SİRAL          | 63 | 66,1 | 15 m |  | 289,82 |



|  |   |    |      |      |  |        |
|--|---|----|------|------|--|--------|
| <b>EKO SERİSİ İZOLELİ ÇELİK SİRALLER - KILAVUZ TELLİ</b>  |   |    |      |      |  |        |
| 001 054 231011 00 11   | Ø11 EKO İZOLELİ ÇELİK SİRAL (TELLİ)(3/8")   | 11 | 15,2 | 50 m |  | 45,13  |
| 001 054 231014 00 11   | Ø14 EKO İZOLELİ ÇELİK SİRAL (TELLİ)(1/2")   | 14 | 18,4 | 50 m |  | 54,67  |
| 001 054 231016 00 11   | Ø16 EKO İZOLELİ ÇELİK SİRAL (TELLİ)         | 16 | 20,4 | 50 m |  | 58,29  |
| 001 054 231018 00 11   | Ø18 EKO İZOLELİ ÇELİK SİRAL (TELLİ)         | 18 | 22,4 | 50 m |  | 65,66  |
| 001 054 231021 00 11   | Ø21 EKO İZOLELİ ÇELİK SİRAL (TELLİ) (3/4")  | 21 | 25,4 | 50 m |  | 77,28  |
| 001 054 231026 00 11   | Ø26 EKO İZOLELİ ÇELİK SİRAL (TELLİ)(1")     | 26 | 30,4 | 25 m |  | 94,94  |
| 001 054 231029 00 11   | Ø29 EKO İZOLELİ ÇELİK SİRAL (TELLİ)(1 1/4") | 29 | 33,4 | 25 m |  | 101,86 |
| 001 054 231032 00 11   | Ø32 EKO İZOLELİ ÇELİK SİRAL (TELLİ)         | 32 | 36,4 | 25 m |  | 119,77 |
| 001 054 231037 00 11   | Ø37 EKO İZOLELİ ÇELİK SİRAL (TELLİ)(1 1/2") | 37 | 42,4 | 25 m |  | 147,43 |
| 001 054 231042 00 11   | Ø42 EKO İZOLELİ ÇELİK SİRAL (TELLİ)         | 42 | 46,4 | 25 m |  | 176,38 |
| 001 054 231050 00 11   | Ø50 EKO İZOLELİ ÇELİK SİRAL (TELLİ) (2")    | 50 | 54,4 | 25 m |  | 235,97 |
| 001 054 231063 00 11   | Ø63 EKO İZOLELİ ÇELİK SİRAL                 | 63 | 66,1 | 15 m |  | 302,39 |



| Ürün Kodu | Ürün Adı | Ort. İç Çap | Ort. Dış Çap | Kutu Metre/Ad. | Koli Adet | Fiyat (₺) |
|-----------|----------|-------------|--------------|----------------|-----------|-----------|
|-----------|----------|-------------|--------------|----------------|-----------|-----------|

**MEKS SERİSİ ÇELİK SİRALLER**

|                      |                             |    |      |      |     |        |
|----------------------|-----------------------------|----|------|------|-----|--------|
| 001 054 120009 00 66 | Ø9 ÇELİK SİRALLER           | 9  | 12,1 | 50 m | 200 | 34,59  |
| 001 054 120011 00 66 | Ø11 ÇELİK SİRALLER(3/8")    | 11 | 14,1 | 50 m | 200 | 36,00  |
| 001 054 120014 00 66 | Ø14 ÇELİK SİRALLER(1/2")    | 14 | 17,1 | 50 m | 200 | 43,33  |
| 001 054 120016 00 66 | Ø16 ÇELİK SİRALLER          | 16 | 19,1 | 50 m | 200 | 47,61  |
| 001 054 120018 00 66 | Ø18 ÇELİK SİRALLER          | 18 | 21,1 | 50 m | 200 | 52,16  |
| 001 054 120021 00 66 | Ø21 ÇELİK SİRALLER (3/4")   | 21 | 24,1 | 50 m | 200 | 57,94  |
| 001 054 120026 00 66 | Ø26 ÇELİK SİRALLER(1")      | 26 | 29,1 | 25 m | 100 | 75,89  |
| 001 054 120029 00 66 | Ø29 ÇELİK SİRALLER(1 1/4")  | 29 | 32,1 | 25 m | 100 | 81,40  |
| 001 054 120032 00 66 | Ø32 ÇELİK SİRALLER          | 32 | 35,1 | 25 m | 100 | 90,42  |
| 001 054 120037 00 66 | Ø37 ÇELİK SİRALLER (1 1/2") | 37 | 41,1 | 25 m | 100 | 113,66 |
| 001 054 120042 00 66 | Ø42 ÇELİK SİRALLER          | 42 | 45,1 | 25 m | 100 | 135,41 |
| 001 054 120050 00 66 | Ø50 ÇELİK SİRALLER(2")      | 50 | 53,1 | 25 m | 100 | 191,16 |
| 001 054 120063 00 66 | Ø63 ÇELİK SİRALLER          | 63 | 66,1 | 15 m | 60  | 259,53 |

**MEKS SERİSİ ÇELİK SİRALLER (KILAVUZ TELLİ)**

|                      |                                 |    |      |      |     |        |
|----------------------|---------------------------------|----|------|------|-----|--------|
| 001 054 121011 00 66 | Ø11 ÇELİK SİRAL (TELLİ)(3/8")   | 11 | 14,1 | 50 m | 200 | 40,24  |
| 001 054 121014 00 66 | Ø14 ÇELİK SİRAL (TELLİ)(1/2")   | 14 | 17,1 | 50 m | 200 | 48,85  |
| 001 054 121016 00 66 | Ø16 ÇELİK SİRAL (TELLİ)         | 16 | 19,1 | 50 m | 200 | 51,70  |
| 001 054 121018 00 66 | Ø18 ÇELİK SİRAL (TELLİ)         | 18 | 21,1 | 50 m | 200 | 62,94  |
| 001 054 121021 00 66 | Ø21 ÇELİK SİRAL (TELLİ) (3/4")  | 21 | 24,1 | 50 m | 200 | 64,77  |
| 001 054 121026 00 66 | Ø26 ÇELİK SİRAL (TELLİ)(1")     | 26 | 29,1 | 25 m | 100 | 86,18  |
| 001 054 121029 00 66 | Ø29 ÇELİK SİRAL (TELLİ)(1 1/4") | 29 | 32,1 | 25 m | 100 | 91,02  |
| 001 054 121032 00 66 | Ø32 ÇELİK SİRAL (TELLİ)         | 32 | 35,1 | 25 m | 100 | 103,84 |
| 001 054 121037 00 66 | Ø37 ÇELİK SİRAL (TELLİ)(1 1/2") | 37 | 41,1 | 25 m | 100 | 126,53 |
| 001 054 121042 00 66 | Ø42 ÇELİK SİRAL (TELLİ)         | 42 | 45,1 | 25 m | 100 | 147,85 |
| 001 054 121050 00 66 | Ø50 ÇELİK SİRAL (TELLİ) (2")    | 50 | 53,1 | 25 m | 100 | 201,84 |
| 001 054 121063 00 66 | Ø63 ÇELİK SİRAL (TELLİ) (2")    | 63 | 66,1 | 15 m | 60  | 274,15 |

**MEKS SERİSİ İZOLELİ ÇELİK SİRALLER**

|                      |                                  |    |      |      |  |        |
|----------------------|----------------------------------|----|------|------|--|--------|
| 001 054 130009 00 11 | Ø9 İZOLELİ ÇELİK SİRAL           | 9  | 13,2 | 50 m |  | 44,34  |
| 001 054 130011 00 11 | Ø11 İZOLELİ ÇELİK SİRAL(3/8")    | 11 | 15,2 | 50 m |  | 52,78  |
| 001 054 130014 00 11 | Ø14 İZOLELİ ÇELİK SİRAL(1/2")    | 14 | 18,4 | 50 m |  | 58,57  |
| 001 054 130016 00 11 | Ø16 İZOLELİ ÇELİK SİRAL          | 16 | 20,4 | 50 m |  | 67,65  |
| 001 054 130018 00 11 | Ø18 İZOLELİ ÇELİK SİRAL          | 18 | 22,4 | 50 m |  | 82,61  |
| 001 054 130026 00 11 | Ø26 İZOLELİ ÇELİK SİRAL(1")      | 26 | 30,4 | 25 m |  | 97,20  |
| 001 054 130029 00 11 | Ø29 İZOLELİ ÇELİK SİRAL(1 1/4")  | 29 | 33,4 | 25 m |  | 110,87 |
| 001 054 130032 00 11 | Ø32 İZOLELİ ÇELİK SİRAL          | 32 | 36,4 | 25 m |  | 125,93 |
| 001 054 130037 00 11 | Ø37 İZOLELİ ÇELİK SİRAL (1 1/2") | 37 | 42,4 | 25 m |  | 152,87 |
| 001 054 130042 00 11 | Ø42 İZOLELİ ÇELİK SİRAL          | 42 | 46,4 | 25 m |  | 191,19 |
| 001 054 130050 00 11 | Ø50 İZOLELİ ÇELİK SİRAL(2")      | 50 | 54,4 | 25 m |  | 256,23 |
| 001 054 130063 00 11 | Ø63 İZOLELİ ÇELİK SİRAL          | 63 | 67,2 | 15 m |  | 329,32 |

**MEKS SERİSİ İZOLELİ ÇELİK SİRALLER - KILAVUZ TELLİ**

|                      |   |    |      |      |  |        |
|----------------------|---|----|------|------|--|--------|
| 001 054 140011 00 11 | Ø11 İZOLELİ ÇELİK SİRAL (TELLİ)(3/8")   | 11 | 15,2 | 50 m |  | 49,98  |
| 001 054 140014 00 11 | Ø14 İZOLELİ ÇELİK SİRAL (TELLİ)(1/2")   | 14 | 18,4 | 50 m |  | 60,55  |
| 001 054 140016 00 11 | Ø16 İZOLELİ ÇELİK SİRAL (TELLİ)         | 16 | 20,4 | 50 m |  | 63,74  |
| 001 054 140018 00 11 | Ø18 İZOLELİ ÇELİK SİRAL (TELLİ)         | 18 | 22,4 | 50 m |  | 69,95  |
| 001 054 140026 00 11 | Ø26 İZOLELİ ÇELİK SİRAL (TELLİ)(1")     | 26 | 30,4 | 25 m |  | 103,66 |
| 001 054 140029 00 11 | Ø29 İZOLELİ ÇELİK SİRAL (TELLİ)(1 1/4") | 29 | 33,4 | 25 m |  | 116,77 |
| 001 054 140032 00 11 | Ø32 İZOLELİ ÇELİK SİRAL (TELLİ)         | 32 | 36,4 | 25 m |  | 136,70 |
| 001 054 140037 00 11 | Ø37 İZOLELİ ÇELİK SİRAL (TELLİ)(1 1/2") | 37 | 42,4 | 25 m |  | 161,55 |
| 001 054 140042 00 11 | Ø42 İZOLELİ ÇELİK SİRAL (TELLİ)         | 42 | 46,4 | 25 m |  | 202,81 |
| 001 054 140050 00 11 | Ø50 İZOLELİ ÇELİK SİRAL (TELLİ) (2")    | 50 | 54,4 | 25 m |  | 267,49 |
| 001 054 140063 00 11 | Ø63 İZOLELİ ÇELİK SİRAL (TELLİ)         | 63 | 67,2 | 15 m |  | 342,33 |

**NİKEL KAPLI ÇELİK SİRAL RAKORU**

|                |                             |  |  |       |  |         |
|----------------|-----------------------------|--|--|-------|--|---------|
| 012 097 030009 | CLK-9 ÇELİK SİRAL RAKORU    |  |  | 1 ad. |  | 6,71 €  |
| 012 097 030011 | CLK-11 ÇELİK SİRAL RAKORU   |  |  | 1 ad. |  | 7,87 €  |
| 012 097 030014 | CLK-13,5 ÇELİK SİRAL RAKORU |  |  | 1 ad. |  | 12,50 € |
| 012 097 030016 | CLK-16 ÇELİK SİRAL RAKORU   |  |  | 1 ad. |  | 13,66 € |
| 012 097 030018 | CLK-18 ÇELİK SİRAL RAKORU   |  |  | 1 ad. |  | 20,00 € |
| 012 097 030026 | CLK-26 ÇELİK SİRAL RAKORU   |  |  | 1 ad. |  | 33,33 € |



| Ürün Kodu | Ürün Adı | Kutu Metre | Koli Adet | Fiyat (₺) |
|-----------|----------|------------|-----------|-----------|
|-----------|----------|------------|-----------|-----------|

### PVC ALEV YAYMAYAN BOY BORULAR

|                      |                                      |    |       |        |
|----------------------|--------------------------------------|----|-------|--------|
| 001 045 120014 30 17 | Ø14 PVC ALEV YAYMAYAN BOY BORU (3 m) | CC | 102 m | 25,93  |
| 001 045 120016 30 17 | Ø16 PVC ALEV YAYMAYAN BOY BORU (3 m) | CC | 102 m | 31,48  |
| 001 045 120018 30 17 | Ø18 PVC ALEV YAYMAYAN BOY BORU (3 m) | CC | 102 m | 33,33  |
| 001 045 120020 30 17 | Ø20 PVC ALEV YAYMAYAN BOY BORU (3 m) | CC | 102 m | 45,37  |
| 001 045 120025 30 17 | Ø25 PVC ALEV YAYMAYAN BOY BORU (3 m) | CC | 51 m  | 61,11  |
| 001 045 120032 30 17 | Ø32 PVC ALEV YAYMAYAN BOY BORU (3 m) | CC | 30 m  | 101,85 |
| 001 045 120040 30 17 | Ø40 PVC ALEV YAYMAYAN BOY BORU (3 m) | CC | 30 m  | 190,74 |

### PVC ALEV YAYMAYAN KENDİNDEN MUFLU BOY BORULAR

|                      |  |    |       |        |
|----------------------|--|----|-------|--------|
| 001 045 110014 30 17 | Ø14 PVC ALEV YAYMAYAN KENDİNDEN MUFLU BOY BORU (3 m) | CC | 102 m | 29,63  |
| 001 045 110016 30 17 | Ø16 PVC ALEV YAYMAYAN KENDİNDEN MUFLU BOY BORU (3 m) | CC | 102 m | 36,11  |
| 001 045 110018 30 17 | Ø18 PVC ALEV YAYMAYAN KENDİNDEN MUFLU BOY BORU (3 m) | CC | 102 m | 38,15  |
| 001 045 110020 30 17 | Ø20 PVC ALEV YAYMAYAN KENDİNDEN MUFLU BOY BORU (3 m) | CC | 102 m | 51,85  |
| 001 045 110025 30 17 | Ø25 PVC ALEV YAYMAYAN KENDİNDEN MUFLU BOY BORU (3 m) | CC | 51 m  | 70,37  |
| 001 045 110032 30 17 | Ø32 PVC ALEV YAYMAYAN KENDİNDEN MUFLU BOY BORU (3 m) | CC | 30 m  | 116,67 |
| 001 045 110040 30 17 | Ø40 PVC ALEV YAYMAYAN KENDİNDEN MUFLU BOY BORU (3 m) | CC | 30 m  | 218,52 |

### DİRSEK VE MUFLAR - ALEV YAYMAYAN

|                      |                          |    |         |     |       |
|----------------------|--------------------------|----|---------|-----|-------|
| 001 051 010014 00 17 | Ø14 DİRSEK ALEV YAYMAYAN | CC | 100 ad. | 700 | 14,81 |
| 001 051 010016 00 17 | Ø16 DİRSEK ALEV YAYMAYAN | CC | 100 ad. | 600 | 15,56 |
| 001 051 010018 00 17 | Ø18 DİRSEK ALEV YAYMAYAN | CC | 100 ad. | 400 | 16,85 |
| 001 051 010020 00 17 | Ø20 DİRSEK ALEV YAYMAYAN | CC | 100 ad. | 300 | 18,52 |
| 001 051 010025 00 17 | Ø25 DİRSEK ALEV YAYMAYAN | CC | 50 ad.  | 150 | 36,11 |
| 001 051 010032 00 17 | Ø32 DİRSEK ALEV YAYMAYAN | CC | 50 ad.  | 100 | 55,56 |
| 001 051 030014 00 17 | Ø14-16 MUF ALEV YAYMAYAN | CC | 100 ad. | 700 | 8,70  |
| 001 051 030018 00 17 | Ø18-20 MUF ALEV YAYMAYAN | CC | 100 ad. | 500 | 9,26  |
| 001 051 030025 00 17 | Ø25 MUF ALEV YAYMAYAN    | CC | 50 ad.  | 300 | 27,78 |
| 001 051 030032 00 17 | Ø32 MUF ALEV YAYMAYAN    | CC | 50 ad.  | 200 | 36,11 |

### GEÇMELİ TİP ANTİGRON BORU KROŞESİ

XX yerine Gri için 17, Beyaz için 00 rakamını yazınız.

|                      |  |  |         |      |       |
|----------------------|--|--|---------|------|-------|
| 001 048 010016 00 XX | Ø16 ANTİGRON BORU KROŞESİ (GEÇMELİ)            |  | 100 ad. | 2000 | 3,70  |
| 001 048 010018 00 XX | Ø18 ANTİGRON BORU KROŞESİ (GEÇMELİ)            |  | 100 ad. | 3000 | 7,22  |
| 001 048 010020 00 XX | Ø20 ANTİGRON BORU KROŞESİ (GEÇMELİ)            |  | 100 ad. | 4500 | 7,41  |
| 001 048 010025 00 XX | Ø25 ANTİGRON BORU KROŞESİ (GEÇMELİ)            |  | 100 ad. | 1000 | 7,78  |
| 001 048 010032 00 XX | Ø32 ANTİGRON BORU KROŞESİ (GEÇMELİ)            |  | 100 ad. | 800  | 8,15  |
| 001 048 010040 00 XX | Ø40 ANTİGRON BORU KROŞESİ (GEÇMELİ)            |  | 50 ad.  | 750  | 15,93 |
| 001 048 020016 00 XX | Ø16 ANTİGRON BORU KROŞESİ (RAY TİPİ - GEÇMELİ) |  | 100 ad. | 2000 | 4,44  |
| 001 048 020020 00 XX | Ø20 ANTİGRON BORU KROŞESİ (RAY TİPİ - GEÇMELİ) |  | 100 ad. | 1500 | 7,78  |
| 001 048 020025 00 XX | Ø25 ANTİGRON BORU KROŞESİ (RAY TİPİ - GEÇMELİ) |  | 100 ad. | 1000 | 8,15  |
| 001 048 020032 00 XX | Ø32 ANTİGRON BORU KROŞESİ (RAY TİPİ - GEÇMELİ) |  | 100 ad. | 800  | 8,52  |
| 074 048 050016       | Ø16 ANTİGRON BORU KROŞESİ KAPAKLI (GEÇMELİ)    |  | 100 ad. | 4000 | 5,33  |
| 074 048 050017       | Ø20 ANTİGRON BORU KROŞESİ KAPAKLI (GEÇMELİ)    |  | 100 ad. | 3500 | 8,15  |
| 074 048 050025       | Ø25 ANTİGRON BORU KROŞESİ KAPAKLI (GEÇMELİ)    |  | 100 ad. | 3000 | 8,89  |
| 074 048 050032       | Ø32 ANTİGRON BORU KROŞESİ KAPAKLI (GEÇMELİ)    |  | 50 ad.  | 1500 | 10,74 |





| Ürün Kodu   | Ürün Adı  | Kutu Mtre/Ad. | Koli Adet | Fiyat (₺) |
|---|---|---------------|-----------|-----------|
| <b>BOY BORULAR - HALOJEN FREE - ALEV YAYMAYAN - FLARET - 320N</b> <span style="float: right;">TS CE</span>  |   |               |           |           |
| 001 045 500016 30 17  | Ø16 HALOJEN FREE ALEV YAYMAYAN BORU(3 m)(320N)                | 102 m         |           | 123,79    |
| 001 045 500020 30 17  | Ø20 HALOJEN FREE ALEV YAYMAYAN BORU(3 m)(320N)                | 102 m         |           | 149,42    |
| 001 045 500025 30 17  | Ø25 HALOJEN FREE ALEV YAYMAYAN BORU(3 m)(320N)                | 102 m         |           | 205,55    |
| 001 045 500032 30 17  | Ø32 HALOJEN FREE ALEV YAYMAYAN BORU(3 m)(320N)                | 102 m         |           | 288,94    |
| 001 045 500040 30 17  | Ø40 HALOJEN FREE ALEV YAYMAYAN BORU(3 m)(320N)                | 51 m          |           | 414,19    |
| 001 045 500050 30 17  | Ø50 HALOJEN FREE ALEV YAYMAYAN BORU(3 m)(320N)                | 30 m          |           | 670,52    |
| <b>BOY BORULAR - HALOJEN FREE - ALEV YAYMAYAN - FLARET - 750N</b> <span style="float: right;">TS CE</span>  |   |               |           |           |
| 001 045 510016 30 17  | Ø16 HALOJEN FREE ALEV YAYMAYAN BORU(3 m)(750N)                | 102 m         |           | 130,19    |
| 001 045 510020 30 17  | Ø20 HALOJEN FREE ALEV YAYMAYAN BORU(3 m)(750N)                | 102 m         |           | 162,24    |
| 001 045 510025 30 17  | Ø25 HALOJEN FREE ALEV YAYMAYAN BORU(3 m)(750N)                | 102 m         |           | 218,37    |
| 001 045 510032 30 17  | Ø32 HALOJEN FREE ALEV YAYMAYAN BORU(3 m)(750N)                | 102 m         |           | 307,25    |
| 001 045 510040 30 17  | Ø40 HALOJEN FREE ALEV YAYMAYAN BORU(3 m)(750N)                | 51 m          |           | 438,65    |
| 001 045 510050 30 17  | Ø50 HALOJEN FREE ALEV YAYMAYAN BORU(3 m)(750N)                | 30 m          |           | 765,32    |
| <b>BOY BORULAR - HALOJEN FREE - ALEV YAYMAYAN - FLARET - 1250N</b> <span style="float: right;">TS CE</span> |   |               |           |           |
| 001 045 520016 30 17  | Ø16 HALOJEN FREE ALEV YAYMAYAN BORU(3 m)(1250N)               | 102 m         |           | 141,47    |
| 001 045 520020 30 17  | Ø20 HALOJEN FREE ALEV YAYMAYAN BORU(3 m)(1250N)               | 102 m         |           | 173,51    |
| 001 045 520025 30 17  | Ø25 HALOJEN FREE ALEV YAYMAYAN BORU(3 m)(1250N)               | 102 m         |           | 237,68    |
| 001 045 520032 30 17  | Ø32 HALOJEN FREE ALEV YAYMAYAN BORU(3 m)(1250N)               | 102 m         |           | 342,89    |
| 001 045 520040 30 17  | Ø40 HALOJEN FREE ALEV YAYMAYAN BORU(3 m)(1250N)               | 51 m          |           | 467,81    |
| 001 045 520050 30 17  | Ø50 HALOJEN FREE ALEV YAYMAYAN BORU(3 m)(1250N)               | 30 m          |           | 853,44    |
| <b>BORU - SİRAL EK MUF - ALEV YAYMAYAN</b>  |   |               |           |           |
| 999 999 777616  | 16'LİK BORU-SİRAL EK MUFU ALEV YAYMAYAN                       | 100 ad.       | 4000      | 26,00     |
| 999 999 777620  | 20'LİK BORU-SİRAL EK MUFU ALEV YAYMAYAN                       | 100 ad.       | 2000      | 28,17     |
| 999 999 777625  | 25'LİK BORU-SİRAL EK MUFU ALEV YAYMAYAN                       | 100 ad.       | 2000      | 37,28     |
| 999 999 777632  | 32'LİK BORU-SİRAL EK MUFU ALEV YAYMAYAN                       | 100 ad.       | 1000      | 39,00     |
| <b>DÜZ BORU T DİRSEK - ALEV YAYMAYAN</b>  |   |               |           |           |
| 999 999 999888  | 16'LİK DÜZ BORU T DİRSEK ALEV YAYMAYAN                        | 100 ad.       | 1500      | 47,67     |
| 999 999 999889  | 20'LİK DÜZ BORU T DİRSEK ALEV YAYMAYAN                        | 100 ad.       | 1000      | 56,32     |
| 999 999 999890  | 25'LİK DÜZ BORU T DİRSEK ALEV YAYMAYAN                        | 50 ad.        | 800       | 69,33     |
| 999 999 999891  | 32'LİK DÜZ BORU T DİRSEK ALEV YAYMAYAN                        | 25 ad.        | 500       | 91,00     |
| <b>DÜZ BORU RAKORU - ALEV YAYMAYAN</b>  |   |               |           |           |
| 999 999 998816  | Ø16 DÜZ BORU REKORU ALEV YAYMAYAN                             | 100 ad.       | 4000      | 48,15     |
| 999 999 998820  | Ø20 DÜZ BORU REKORU ALEV YAYMAYAN                             | 100 ad.       | 2500      | 59,26     |
| 999 999 998825  | Ø25 DÜZ BORU REKORU ALEV YAYMAYAN                             | 100 ad.       | 2000      | 70,37     |
| 999 999 998832  | Ø32 DÜZ BORU REKORU ALEV YAYMAYAN                             | 100 ad.       | 1000      | 92,59     |
| <b>ANTİGRON BORU KROŞESİ (GEÇMELİ) - ALEV YAYMAYAN</b>  |   |               |           |           |
| 074 048 060016  | Ø16 ANTİGRON BORU KROŞESİ (GEÇMELİ TİP) KAPAKLI ALEV YAYMAYAN | 100 ad.       | 4000      | 13,00     |
| 074 048 060020  | Ø20 ANTİGRON BORU KROŞESİ (GEÇMELİ TİP) KAPAKLI ALEV YAYMAYAN | 100 ad.       | 3500      | 14,33     |
| 074 048 060025  | Ø25 ANTİGRON BORU KROŞESİ (GEÇMELİ TİP) KAPAKLI ALEV YAYMAYAN | 100 ad.       | 3000      | 16,94     |
| 074 048 060032  | Ø32 ANTİGRON BORU KROŞESİ (GEÇMELİ TİP) KAPAKLI ALEV YAYMAYAN | 100 ad.       | 2000      | 20,83     |
| <b>SİRAL RAKORU - ALEV YAYMAYAN</b>   |   |               |           |           |
| 999 999 777516  | Ø16 KAPAKLI SİRAL REKORU ALEV YAYMAYAN                        | 100 ad.       | 4000      | 49,83     |
| 999 999 777520  | Ø20 KAPAKLI SİRAL REKORU ALEV YAYMAYAN                        | 100 ad.       | 3000      | 56,33     |
| 999 999 777525  | Ø25 KAPAKLI SİRAL REKORU ALEV YAYMAYAN                        | 100 ad.       | 1800      | 73,67     |
| 999 999 777532  | Ø32 KAPAKLI SİRAL REKORU ALEV YAYMAYAN                        | 100 ad.       | 1000      | 95,33     |

| Ürün Kodu | Ürün Adı |  | Kutu<br>Metre/Ad. | Fiyat (₺) |
|-----------|----------|--|-------------------|-----------|
|-----------|----------|--|-------------------|-----------|

### YENİ MUTLUSAN EKO SERİSİ TURUNCU BORULAR - HALOJEN FREE - ALEV YAYAN - 320N - 6 ATÜ

|                      |  |     |       |        |
|----------------------|--|-----|-------|--------|
| 001 165 710014 00 12 | Ø14/6 ATÜ BORU (HALOJEN FREE TURUNCU) (ALEV YAYAN) (EKO) | ☺☺  | 200 m | 14,24  |
| 001 165 710016 00 12 | Ø16/6 ATÜ BORU (HALOJEN FREE TURUNCU) (ALEV YAYAN) (EKO) | ☺☺☺ | 200 m | 17,07  |
| 001 165 710018 00 12 | Ø18/6 ATÜ BORU (HALOJEN FREE TURUNCU) (ALEV YAYAN) (EKO) | ☺☺  | 200 m | 19,69  |
| 001 165 710020 00 12 | Ø20/6 ATÜ BORU (HALOJEN FREE TURUNCU) (ALEV YAYAN) (EKO) | ☺☺☺ | 200 m | 21,55  |
| 001 165 710025 00 12 | Ø25/6 ATÜ BORU (HALOJEN FREE TURUNCU) (ALEV YAYAN) (EKO) | ☺☺☺ | 100 m | 35,26  |
| 001 165 710032 00 12 | Ø32/6 ATÜ BORU (HALOJEN FREE TURUNCU) (ALEV YAYAN) (EKO) | ☺☺☺ | 100 m | 54,22  |
| 001 165 710040 00 12 | Ø40/6 ATÜ BORU (HALOJEN FREE TURUNCU) (ALEV YAYAN) (EKO) | ☺☺☺ | 100 m | 81,65  |
| 001 165 710050 00 12 | Ø50/6 ATÜ BORU (HALOJEN FREE TURUNCU) (ALEV YAYAN) (EKO) | ☺☺☺ | 100 m | 142,15 |

### YENİ MUTLUSAN EKO SERİSİ MAVİ BORULAR - HALOJEN FREE - ALEV YAYAN - 320N - 6 ATÜ

|                      |   |     |       |        |
|----------------------|---|-----|-------|--------|
| 001 165 710014 00 13 | Ø14/6 ATÜ BORU (HALOJEN FREE MAVİ) (ALEV YAYAN) (EKO) | ☺☺  | 200 m | 14,24  |
| 001 165 710016 00 13 | Ø16/6 ATÜ BORU (HALOJEN FREE MAVİ) (ALEV YAYAN) (EKO) | ☺☺☺ | 200 m | 17,07  |
| 001 165 710018 00 13 | Ø18/6 ATÜ BORU (HALOJEN FREE MAVİ) (ALEV YAYAN) (EKO) | ☺☺  | 200 m | 19,69  |
| 001 165 710020 00 13 | Ø20/6 ATÜ BORU (HALOJEN FREE MAVİ) (ALEV YAYAN) (EKO) | ☺☺☺ | 200 m | 21,55  |
| 001 165 710025 00 13 | Ø25/6 ATÜ BORU (HALOJEN FREE MAVİ) (ALEV YAYAN) (EKO) | ☺☺☺ | 100 m | 35,26  |
| 001 165 710032 00 13 | Ø32/6 ATÜ BORU (HALOJEN FREE MAVİ) (ALEV YAYAN) (EKO) | ☺☺☺ | 100 m | 54,22  |
| 001 165 710040 00 13 | Ø40/6 ATÜ BORU (HALOJEN FREE MAVİ) (ALEV YAYAN) (EKO) | ☺☺☺ | 100 m | 81,65  |
| 001 165 710050 00 13 | Ø50/6 ATÜ BORU (HALOJEN FREE MAVİ) (ALEV YAYAN) (EKO) | ☺☺☺ | 100 m | 142,15 |

### MEKS SERİSİ TURUNCU BORULAR - HALOJEN FREE - ALEV YAYAN - 320N - 6 ATÜ

|                      |   |     |       |        |
|----------------------|---|-----|-------|--------|
| 001 165 506014 00 12 | Ø14/6 ATÜ BORU (HALOJEN FREE)(ALEV YAYAN) | ☺☺  | 100 m | 19,34  |
| 001 165 506016 00 12 | Ø16/6 ATÜ BORU (HALOJEN FREE)(ALEV YAYAN) | ☺☺☺ | 100 m | 22,13  |
| 001 165 506018 00 12 | Ø18/6 ATÜ BORU (HALOJEN FREE)(ALEV YAYAN) | ☺☺  | 100 m | 24,83  |
| 001 165 506020 00 12 | Ø20/6 ATÜ BORU (HALOJEN FREE)(ALEV YAYAN) | ☺☺☺ | 100 m | 27,27  |
| 001 165 506025 00 12 | Ø25/6 ATÜ BORU (HALOJEN FREE)(ALEV YAYAN) | ☺☺☺ | 100 m | 38,22  |
| 001 165 506032 00 12 | Ø32/6 ATÜ BORU (HALOJEN FREE)(ALEV YAYAN) | ☺☺☺ | 100 m | 57,01  |
| 001 165 506037 00 12 | Ø37/6 ATÜ BORU (HALOJEN FREE)(ALEV YAYAN) | ☺☺  | 100 m | 83,75  |
| 001 165 506040 00 12 | Ø40/6 ATÜ BORU (HALOJEN FREE)(ALEV YAYAN) | ☺☺☺ | 100 m | 87,63  |
| 001 165 506050 00 12 | Ø50/6 ATÜ BORU (HALOJEN FREE)(ALEV YAYAN) | ☺☺☺ | 100 m | 143,09 |
| 001 165 506063 00 12 | Ø63/6 ATÜ BORU (HALOJEN FREE)(ALEV YAYAN) | ☺☺☺ | 100 m | 192,15 |
| 001 165 506075 00 12 | Ø75/6 ATÜ BORU (HALOJEN FREE)(ALEV YAYAN) | ☺☺☺ | 100 m | 256,78 |
| 001 165 506090 00 12 | Ø90/6 ATÜ BORU (HALOJEN FREE)(ALEV YAYAN) | ☺☺☺ | 75 m  | 382,60 |

### MEKS SERİSİ TURUNCU BORULAR - HALOJEN FREE - ALEV YAYAN - 750N - 10 ATÜ

|                      |   |     |       |        |
|----------------------|---|-----|-------|--------|
| 001 165 510014 00 12 | Ø14/10 ATÜ BORU (HALOJEN FREE)(ALEV YAYAN)  | ☺☺  | 100 m | 20,75  |
| 001 165 510016 00 12 | Ø16/10 ATÜ BORU (HALOJEN FREE)(ALEV YAYAN)  | ☺☺☺ | 100 m | 23,39  |
| 001 165 510018 00 12 | Ø18/10 ATÜ BORU (HALOJEN FREE)(ALEV YAYAN)  | ☺☺  | 100 m | 27,20  |
| 001 165 510020 00 12 | Ø20/10 ATÜ BORU (HALOJEN FREE)(ALEV YAYAN)  | ☺☺☺ | 100 m | 32,15  |
| 001 165 510025 00 12 | Ø25/10 ATÜ BORU (HALOJEN FREE)(ALEV YAYAN)  | ☺☺☺ | 100 m | 40,93  |
| 001 165 510032 00 12 | Ø32/10 ATÜ BORU (HALOJEN FREE)(ALEV YAYAN)  | ☺☺☺ | 100 m | 60,06  |
| 001 165 510037 00 12 | Ø37/10 ATÜ BORU (HALOJEN FREE)(ALEV YAYAN)  | ☺☺  | 100 m | 95,49  |
| 001 165 510040 00 12 | Ø40/10 ATÜ BORU (HALOJEN FREE)(ALEV YAYAN)  | ☺☺☺ | 100 m | 100,31 |
| 001 165 510050 00 12 | Ø50/10 ATÜ BORU (HALOJEN FREE)(ALEV YAYAN)  | ☺☺☺ | 100 m | 165,00 |
| 001 165 510063 00 12 | Ø63/10 ATÜ BORU (HALOJEN FREE)(ALEV YAYAN)  | ☺☺☺ | 100 m | 216,32 |
| 001 165 510075 00 12 | Ø75/10 ATÜ BORU (HALOJEN FREE)(ALEV YAYAN)  | ☺☺☺ | 100 m | 298,84 |
| 001 165 510090 00 12 | Ø90/10 ATÜ BORU (HALOJEN FREE)(ALEV YAYAN)  | ☺☺  | 75 m  | 416,67 |
| 001 165 510100 00 12 | Ø100/10 ATÜ BORU (HALOJEN FREE)(ALEV YAYAN) | ☺☺  | 75 m  | 516,96 |
| 001 165 510110 00 12 | Ø110/10 ATÜ BORU (HALOJEN FREE)(ALEV YAYAN) | ☺☺  | 50 m  | 610,18 |

### MEKS SERİSİ TURUNCU BORULAR - HALOJEN FREE - ALEV YAYAN - 1250N

|                      |                                      |     |       |        |
|----------------------|--------------------------------------|-----|-------|--------|
| 001 165 512020 00 12 | 20 Ø BORU (HALOJEN FREE)(ALEV YAYAN) | ☺☺☺ | 100 m | 67,91  |
| 001 165 512025 00 12 | 25 Ø BORU (HALOJEN FREE)(ALEV YAYAN) | ☺☺☺ | 100 m | 83,06  |
| 001 165 512032 00 12 | 32 Ø BORU (HALOJEN FREE)(ALEV YAYAN) | ☺☺☺ | 100 m | 123,41 |





| Ürün Kodu   | Ürün Adı  | Kutu Mt./Ad. | Fiyat (₺) |
|---|---|--------------|-----------|
| <b>MEKS SERİSİ TURUNCU BORULAR - HALOJEN FREE - ALEV YAYMAYAN - 320N - 6 ATÜ</b>    |   |              |           |
| 001 165 106014 00 12  | Ø14/6 ATÜ BORU (HALOJEN FREE)(ALEV YAYMAYANYAYMAYAN) €€             | 100 m        | 27,39     |
| 001 165 106016 00 12  | Ø16/6 ATÜ BORU (HALOJEN FREE)(ALEV YAYMAYANYAYMAYAN) €€             | 100 m        | 31,88     |
| 001 165 106018 00 12  | Ø18/6 ATÜ BORU (HALOJEN FREE)(ALEV YAYMAYANYAYMAYAN) €€             | 100 m        | 36,34     |
| 001 165 106020 00 12  | Ø20/6 ATÜ BORU (HALOJEN FREE)(ALEV YAYMAYANYAYMAYAN) €€             | 100 m        | 40,00     |
| 001 165 106025 00 12  | Ø25/6 ATÜ BORU (HALOJEN FREE)(ALEV YAYMAYANYAYMAYAN) €€             | 100 m        | 57,99     |
| 001 165 106032 00 12  | Ø32/6 ATÜ BORU (HALOJEN FREE)(ALEV YAYMAYANYAYMAYAN) €€             | 100 m        | 85,42     |
| 001 165 106037 00 12  | Ø37/6 ATÜ BORU (HALOJEN FREE)(ALEV YAYMAYANYAYMAYAN) €€             | 100 m        | 124,54    |
| 001 165 106040 00 12  | Ø40/6 ATÜ BORU (HALOJEN FREE)(ALEV YAYMAYANYAYMAYAN) €€             | 100 m        | 142,49    |
| 001 165 106050 00 12  | Ø50/6 ATÜ BORU (HALOJEN FREE)(ALEV YAYMAYANYAYMAYAN) €€             | 100 m        | 209,12    |
| 001 165 106063 00 12  | Ø63/6 ATÜ BORU (HALOJEN FREE)(ALEV YAYMAYANYAYMAYAN) €€             | 100 m        | 281,91    |
| 001 165 106075 00 12  | Ø75/6 ATÜ BORU (HALOJEN FREE)(ALEV YAYMAYANYAYMAYAN) €€             | 100 m        | 370,21    |
| 001 165 106090 00 12  | Ø90/6 ATÜ BORU (HALOJEN FREE)(ALEV YAYMAYANYAYMAYAN) €€             | 75 m         | 572,88    |
| <b>MEKS SERİSİ TURUNCU BORULAR - HALOJEN FREE - ALEV YAYMAYAN - 750N - 10 ATÜ</b>   |   |              |           |
| 001 165 110014 00 12  | Ø14/10 ATÜ BORU (HALOJEN FREE)(ALEV YAYMAYANYAYMAYAN) €€            | 100 m        | 29,73     |
| 001 165 110016 00 12  | Ø16/10 ATÜ BORU (HALOJEN FREE)(ALEV YAYMAYANYAYMAYAN) €€            | 100 m        | 34,71     |
| 001 165 110018 00 12  | Ø18/10 ATÜ BORU (HALOJEN FREE)(ALEV YAYMAYANYAYMAYAN) €€            | 100 m        | 41,37     |
| 001 165 110020 00 12  | Ø20/10 ATÜ BORU (HALOJEN FREE)(ALEV YAYMAYANYAYMAYAN) €€            | 100 m        | 50,48     |
| 001 165 110025 00 12  | Ø25/10 ATÜ BORU (HALOJEN FREE)(ALEV YAYMAYANYAYMAYAN) €€            | 100 m        | 63,72     |
| 001 165 110032 00 12  | Ø32/10 ATÜ BORU (HALOJEN FREE)(ALEV YAYMAYANYAYMAYAN) €€            | 100 m        | 98,44     |
| 001 165 110037 00 12  | Ø37/10 ATÜ BORU (HALOJEN FREE)(ALEV YAYMAYANYAYMAYAN) €€            | 100 m        | 155,74    |
| 001 165 110040 00 12  | Ø40/10 ATÜ BORU (HALOJEN FREE)(ALEV YAYMAYANYAYMAYAN) €€            | 100 m        | 163,40    |
| 001 165 110050 00 12  | Ø50/10 ATÜ BORU (HALOJEN FREE)(ALEV YAYMAYANYAYMAYAN) €€            | 100 m        | 248,31    |
| 001 165 110063 00 12  | Ø63/10 ATÜ BORU (HALOJEN FREE)(ALEV YAYMAYANYAYMAYAN) €€            | 100 m        | 319,33    |
| 001 165 110075 00 12  | Ø75/10 ATÜ BORU (HALOJEN FREE)(ALEV YAYMAYANYAYMAYAN) €€            | 100 m        | 447,18    |
| 001 165 110090 00 12  | Ø90/10 ATÜ BORU (HALOJEN FREE)(ALEV YAYMAYANYAYMAYAN) €€            | 75 m         | 631,39    |
| 001 165 110100 00 12  | Ø100/10 ATÜ BORU (HALOJEN FREE)(ALEV YAYMAYANYAYMAYAN) €€           | 75 m         | 816,93    |
| 001 165 110110 00 12  | Ø110/10 ATÜ BORU (HALOJEN FREE)(ALEV YAYMAYANYAYMAYAN) €€           | 50 m         | 1.010,53  |
| <b>MEKS SERİSİ BORULAR - HALOJEN FREE - ALEV YAYMAYAN - 1250N</b>                   |   |              |           |
| 001 165 112020 00 12  | Ø20 BORU (HALOJEN FREE)(ALEV YAYMAYANYAYMAYAN) €€                   | 100 m        | 95,66     |
| 001 165 112025 00 12  | Ø25 BORU (HALOJEN FREE)(ALEV YAYMAYANYAYMAYAN) €€                   | 100 m        | 122,39    |
| 001 165 112032 00 12  | Ø32 BORU (HALOJEN FREE)(ALEV YAYMAYANYAYMAYAN) €€                   | 100 m        | 189,68    |
| <b>MEKS SERİSİ TURUNCU BORU - HALOJEN FREE - ALEV YAYAN - TELLİ - 320N - 6 ATÜ</b>  |   |              |           |
| 001 165 906014 00 12  | Ø14/6 ATÜ BORU(HALOJEN FREE)(ALEV YAYMAYANYAYAN)(TELLİ)(TURUNCU)    | 100 m        | 20,96     |
| 001 165 906016 00 12  | Ø16/6 ATÜ BORU(HALOJEN FREE)(ALEV YAYMAYANYAYAN)(TELLİ)(TURUNCU)    | 100 m        | 23,75     |
| 001 165 906018 00 12  | Ø18/6 ATÜ BORU(HALOJEN FREE)(ALEV YAYMAYANYAYAN)(TELLİ)(TURUNCU)    | 100 m        | 26,45     |
| 001 165 906020 00 12  | Ø20/6 ATÜ BORU(HALOJEN FREE)(ALEV YAYMAYANYAYAN)(TELLİ)(TURUNCU)    | 100 m        | 28,89     |
| 001 165 906025 00 12  | Ø25/6 ATÜ BORU(HALOJEN FREE)(ALEV YAYMAYANYAYAN)(TELLİ)(TURUNCU)    | 100 m        | 39,84     |
| 001 165 906032 00 12  | Ø32/6 ATÜ BORU(HALOJEN FREE)(ALEV YAYMAYANYAYAN)(TELLİ)(TURUNCU)    | 100 m        | 58,63     |
| 001 165 906037 00 12  | Ø37/6 ATÜ BORU(HALOJEN FREE)(ALEV YAYMAYANYAYAN)(TELLİ)(TURUNCU)    | 100 m        | 85,37     |
| 001 165 906040 00 12  | Ø40/6 ATÜ BORU(HALOJEN FREE)(ALEV YAYMAYANYAYAN)(TELLİ)(TURUNCU)    | 100 m        | 89,25     |
| <b>MEKS SERİSİ TURUNCU BORU - HALOJEN FREE - ALEV YAYAN - TELLİ - 750N - 10 ATÜ</b> |   |              |           |
| 001 165 910014 00 12  | Ø14/10 ATÜ BORU(HALOJEN FREE)(ALEV YAYMAYANYAYAN)(TELLİ)(TURUNCU)   | 100 m        | 22,37     |
| 001 165 910016 00 12  | Ø16/10 ATÜ BORU(HALOJEN FREE)(ALEV YAYMAYANYAYAN)(TELLİ)(TURUNCU)   | 100 m        | 25,01     |
| 001 165 910018 00 12  | Ø18/10 ATÜ BORU(HALOJEN FREE)(ALEV YAYMAYANYAYAN)(TELLİ)(TURUNCU)   | 100 m        | 28,82     |
| 001 165 910020 00 12  | Ø20/10 ATÜ BORU(HALOJEN FREE)(ALEV YAYMAYANYAYAN)(TELLİ)(TURUNCU)   | 100 m        | 33,77     |
| 001 165 910025 00 12  | Ø25/10 ATÜ BORU(HALOJEN FREE)(ALEV YAYMAYANYAYAN)(TELLİ)(TURUNCU)   | 100 m        | 42,55     |
| 001 165 910032 00 12  | Ø32/10 ATÜ BORU(HALOJEN FREE)(ALEV YAYMAYANYAYAN)(TELLİ)(TURUNCU)   | 100 m        | 61,68     |
| 001 165 910037 00 12  | Ø37/10 ATÜ BORU(HALOJEN FREE)(ALEV YAYMAYANYAYAN)(TELLİ)(TURUNCU)   | 100 m        | 97,11     |
| 001 165 910040 00 12  | Ø40/10 ATÜ BORU(HALOJEN FREE)(ALEV YAYMAYANYAYAN)(TELLİ)(TURUNCU)   | 100 m        | 101,94    |
| <b>MEKS SERİSİ BORULAR - HALOJEN FREE - ALEV YAYMAYAN - TELLİ - 320N - 6 ATÜ</b>    |   |              |           |
| 001 165 306014 00 12  | Ø14/6 ATÜ BORU(HALOJEN FREE)(ALEV YAYMAYANYAYMAYAN)(TELLİ)(TURUNCU) | 100 m        | 29,01     |
| 001 165 306016 00 12  | Ø16/6 ATÜ BORU(HALOJEN FREE)(ALEV YAYMAYANYAYMAYAN)(TELLİ)(TURUNCU) | 100 m        | 33,50     |
| 001 165 306018 00 12  | Ø18/6 ATÜ BORU(HALOJEN FREE)(ALEV YAYMAYANYAYMAYAN)(TELLİ)(TURUNCU) | 100 m        | 37,96     |
| 001 165 306020 00 12  | Ø20/6 ATÜ BORU(HALOJEN FREE)(ALEV YAYMAYANYAYMAYAN)(TELLİ)(TURUNCU) | 100 m        | 41,62     |
| 001 165 306025 00 12  | Ø25/6 ATÜ BORU(HALOJEN FREE)(ALEV YAYMAYANYAYMAYAN)(TELLİ)(TURUNCU) | 100 m        | 59,61     |
| 001 165 306032 00 12  | Ø32/6 ATÜ BORU(HALOJEN FREE)(ALEV YAYMAYANYAYMAYAN)(TELLİ)(TURUNCU) | 100 m        | 87,04     |
| 001 165 306037 00 12  | Ø37/6 ATÜ BORU(HALOJEN FREE)(ALEV YAYMAYANYAYMAYAN)(TELLİ)(TURUNCU) | 100 m        | 126,16    |
| 001 165 306040 00 12  | Ø40/6 ATÜ BORU(HALOJEN FREE)(ALEV YAYMAYANYAYMAYAN)(TELLİ)(TURUNCU) | 100 m        | 144,11    |

| Ürün Kodu   | Ürün Adı   | Kutu Mt./Ad. | Fiyat (₺) |
|---|--|--------------|-----------|
| <b>MEKS SERİSİ BORULAR - HALOJEN FREE - ALEV YAYMAYAN - TELLİ - 750N - 10 ATÜ</b> |  |              |           |
| 001 165 310014 00 12  | Ø14/10 ATÜ BORU(H.FREE)(ALEV YAYMAYANYAYMAYAN)(TELLİ)(TURUNCU) | 100 m        | 31,35     |
| 001 165 310016 00 12  | Ø16/10 ATÜ BORU(H.FREE)(ALEV YAYMAYANYAYMAYAN)(TELLİ)(TURUNCU) | 100 m        | 36,33     |
| 001 165 310018 00 12  | Ø18/10 ATÜ BORU(H.FREE)(ALEV YAYMAYANYAYMAYAN)(TELLİ)(TURUNCU) | 100 m        | 42,99     |
| 001 165 310020 00 12  | Ø20/10 ATÜ BORU(H.FREE)(ALEV YAYMAYANYAYMAYAN)(TELLİ)(TURUNCU) | 100 m        | 52,10     |
| 001 165 310025 00 12  | Ø25/10 ATÜ BORU(H.FREE)(ALEV YAYMAYANYAYMAYAN)(TELLİ)(TURUNCU) | 100 m        | 65,34     |
| 001 165 310032 00 12  | Ø32/10 ATÜ BORU(H.FREE)(ALEV YAYMAYANYAYMAYAN)(TELLİ)(TURUNCU) | 100 m        | 100,07    |
| 001 165 310037 00 12  | Ø37/10 ATÜ BORU(H.FREE)(ALEV YAYMAYANYAYMAYAN)(TELLİ)(TURUNCU) | 100 m        | 157,36    |
| 001 165 310040 00 12  | Ø40/10 ATÜ BORU(H.FREE)(ALEV YAYMAYANYAYMAYAN)(TELLİ)(TURUNCU) | 100 m        | 165,02    |



| Ürün Kodu              | Ürün Adı                      | Kutu Mt./Ad. | Koli Adet | Fiyat (₺) |
|------------------------|-------------------------------|--------------|-----------|-----------|
| <b>PLASTİK BORULAR</b> |                               |              |           |           |
| 001 045 000014 30 00   | 14 mm KALIN BOY BORU          | 102 m        | 510 m     | 17,15     |
| 001 045 000018 30 00   | 18 mm KALIN BOY BORU          | 102 m        | 510 m     | 20,38     |
| 001 045 000026 30 00   | 26 mm KALIN BOY BORU          | 51 m         | 255 m     | 34,87     |
| 001 045 000037 30 00   | 37 mm KALIN BOY BORU          | 30 m         |           | 64,67     |
| 001 045 010014 00 11   | 14 mm KANGAL (NORMAL)         | 100 m        |           | 17,15     |
| 001 045 010018 00 11   | 18 mm KANGAL (NORMAL)         | 100 m        |           | 20,38     |
| 001 045 010026 00 11   | 26 mm KANGAL (NORMAL)         | 50 m         |           | 34,87     |
| 001 045 010037 00 11   | 37 mm KANGAL (NORMAL)         | 50 m         |           | 78,99     |
| 001 045 020014 00 00   | 14 mm KANGAL (KAUÇUK)         | 100 m        |           | 17,30     |
| 001 045 020018 00 00   | 18 mm KANGAL (KAUÇUK)         | 100 m        |           | 20,84     |
| 001 045 020026 00 00   | 26 mm KANGAL (KAUÇUK)         | 50 m         |           | 35,34     |
| 001 045 020037 00 00   | 37 mm KANGAL (KAUÇUK)         | 50 m         |           | 81,48     |
| 001 045 030014 00 00   | 14 mm KANGAL (KAUÇUK) (KALIN) | 100 m        |           | 19,58     |
| 001 045 030018 00 00   | 18 mm KANGAL (KAUÇUK) (KALIN) | 100 m        |           | 21,98     |



| Ürün Kodu                       | Ürün Adı            | Kutu Mt./Ad. | Koli Adet | Fiyat (₺) |
|---------------------------------|---------------------|--------------|-----------|-----------|
| <b>PLASTİK DİRSEK VE MUFLAR</b> |                     |              |           |           |
| 127 051 000014                  | PLASTİK 14 Ø DİRSEK | 100 ad.      | 2000      | 6,02      |
| 127 051 000018                  | PLASTİK 18 Ø DİRSEK | 100 ad.      | 1000      | 7,56      |
| 127 051 000026                  | PLASTİK 26 Ø DİRSEK | 100 ad.      | 500       | 13,58     |
| 001 051 020014 00 11            | PLASTİK 14 Ø MUF    |              | 1500      | 7,41      |
| 001 051 020018 00 11            | PLASTİK 18 Ø MUF    |              | 1000      | 13,33     |
| 001 051 020026 00 11            | PLASTİK 26 Ø MUF    |              | 500       | 13,89     |
| 001 051 020037 00 11            | PLASTİK 37 Ø MUF    |              | 250       | 27,78     |



| Ürün Kodu                                      | Ürün Adı                         | Kutu Mt./Ad. | Koli Adet | Fiyat (₺) |
|--|----------------------------------|--------------|-----------|-----------|
| <b>POLİETİLEN SİYAH YERALTI BORULAR - 450N</b> |                                  |              |           |           |
| 001 165 406014 00 11                           | 14/6 ATÜ POLİETİLEN BORU (SİYAH) | €€           | 100 m     | 17,39     |
| 001 165 406016 00 11                           | 16/6 ATÜ POLİETİLEN BORU (SİYAH) | €€           | 100 m     | 19,83     |
| 001 165 406018 00 11                           | 18/6 ATÜ POLİETİLEN BORU (SİYAH) | €€           | 100 m     | 22,06     |
| 001 165 406020 00 11                           | 20/6 ATÜ POLİETİLEN BORU (SİYAH) | €€           | 100 m     | 24,09     |
| 001 165 406025 00 11                           | 25/6 ATÜ POLİETİLEN BORU (SİYAH) | €€           | 100 m     | 33,68     |
| 001 165 406032 00 11                           | 32/6 ATÜ POLİETİLEN BORU (SİYAH) | €€           | 100 m     | 50,04     |
| 001 165 406037 00 11                           | 37/6 ATÜ POLİETİLEN BORU (SİYAH) | €€           | 100 m     | 74,14     |
| 001 165 406040 00 11                           | 40/6 ATÜ POLİETİLEN BORU (SİYAH) | €€           | 100 m     | 75,93     |
| 001 165 406050 00 11                           | 50/6 ATÜ POLİETİLEN BORU (SİYAH) | €€           | 100 m     | 126,59    |
| 001 165 406063 00 11                           | 63/6 ATÜ POLİETİLEN BORU (SİYAH) | €€           | 100 m     | 168,70    |
| 001 165 406075 00 11                           | 75/6 ATÜ POLİETİLEN BORU (SİYAH) | €€           | 100 m     | 228,57    |
| 001 165 406090 00 11                           | 90/6 ATÜ POLİETİLEN BORU (SİYAH) | €€           | 75 m      | 334,27    |

| Ürün Kodu                                       | Ürün Adı                           | Kutu Mt./Ad. | Koli Adet | Fiyat (₺) |
|---|------------------------------------|--------------|-----------|-----------|
| <b>POLİETİLEN SİYAH YER ALTI BORULAR - 750N</b> |                                    |              |           |           |
| 001 165 410014 00 11                            | 14/10 ATÜ POLİETİLEN BORU (SİYAH)  | €€           | 100 m     | 18,61     |
| 001 165 410016 00 11                            | 16/10 ATÜ POLİETİLEN BORU (SİYAH)  | €€           | 100 m     | 20,84     |
| 001 165 410018 00 11                            | 18/10 ATÜ POLİETİLEN BORU (SİYAH)  | €€           | 100 m     | 24,09     |
| 001 165 410020 00 11                            | 20/10 ATÜ POLİETİLEN BORU (SİYAH)  | €€           | 100 m     | 28,14     |
| 001 165 410025 00 11                            | 25/10 ATÜ POLİETİLEN BORU (SİYAH)  | €€           | 100 m     | 35,91     |
| 001 165 410032 00 11                            | 32/10 ATÜ POLİETİLEN BORU (SİYAH)  | €€           | 100 m     | 54,50     |
| 001 165 410037 00 11                            | 37/10 ATÜ POLİETİLEN BORU (SİYAH)  | €€           | 100 m     | 80,22     |
| 001 165 410040 00 11                            | 40/10 ATÜ POLİETİLEN BORU (SİYAH)  | €€           | 100 m     | 79,80     |
| 001 165 410050 00 11                            | 50/10 ATÜ POLİETİLEN BORU (SİYAH)  | €€           | 100 m     | 144,85    |
| 001 165 410063 00 11                            | 63/10 ATÜ POLİETİLEN BORU (SİYAH)  | €€           | 100 m     | 182,90    |
| 001 165 410075 00 11                            | 75/10 ATÜ POLİETİLEN BORU (SİYAH)  | €€           | 100 m     | 262,22    |
| 001 165 410090 00 11                            | 90/10 ATÜ POLİETİLEN BORU (SİYAH)  | €€           | 75 m      | 372,16    |
| 001 165 410100 00 11                            | 100/10 ATÜ POLİETİLEN BORU (SİYAH) | €€           | 75 m      | 453,71    |
| 001 165 410110 00 11                            | 110/10 ATÜ POLİETİLEN BORU (SİYAH) | €€           | 50 m      | 534,86    |





| Ürün Kodu | Ürün Adı | Kutu Metre | Koli Adet | Fiyat (₺) |
|-----------|----------|------------|-----------|-----------|
|-----------|----------|------------|-----------|-----------|

### FİBER SUSTALAR

|                |   |       |  |           |
|----------------|---|-------|--|-----------|
| 999 999 000779 | FİBER KILAVUZ 11 mm (100-120-150-200 Metre) | 1 m   |  | 263,89    |
| 999 999 000780 | FİBER KILAVUZ MAKARASI                      | 1 ad. |  | 12.962,96 |

### PLASTİK SUSTALAR - KILAVUZ TELLİ

|                |                                      |       |    |        |
|----------------|--------------------------------------|-------|----|--------|
| 049 019 400010 | 10 Metre KILAVUZ TELLİ PLASTİK SUSTA | 1 ad. | 25 | 254,63 |
| 049 019 400015 | 15 Metre KILAVUZ TELLİ PLASTİK SUSTA | 1 ad. | 20 | 381,94 |
| 049 019 400020 | 20 Metre KILAVUZ TELLİ PLASTİK SUSTA | 1 ad. | 15 | 509,26 |
| 049 019 400025 | 25 Metre KILAVUZ TELLİ PLASTİK SUSTA | 1 ad. | 15 | 636,57 |

### ÇELİK SUSTALAR

|                      |                                      |        |    |        |
|----------------------|--------------------------------------|--------|----|--------|
| 001 019 000010 00 00 | SUSTA (1.KALİTE) (10 Metre)          | 40 ad. | 40 | 388,89 |
| 001 019 000015 00 00 | SUSTA (1.KALİTE) (15 Metre)          | 30 ad. | 30 | 555,56 |
| 001 019 000020 00 00 | SUSTA (1.KALİTE) (20 Metre)          | 20 ad. | 20 | 740,74 |
| 001 019 000025 00 00 | SUSTA (1.KALİTE) (25 Metre)          | 15 ad. | 15 | 888,89 |
| 001 019 100010 00 00 | TAKVİYELİ SUSTA (1.KALİTE)(10 Metre) | 40 ad. | 40 | 407,41 |
| 001 019 100015 00 00 | TAKVİYELİ SUSTA (1.KALİTE)(15 Metre) | 30 ad. | 30 | 574,07 |
| 001 019 100020 00 00 | TAKVİYELİ SUSTA (1.KALİTE)(20 Metre) | 20 ad. | 20 | 777,78 |
| 001 019 100025 00 00 | TAKVİYELİ SUSTA (1.KALİTE)(25 Metre) | 15 ad. | 15 | 962,96 |

| Ürün Kodu | Ürün Adı | Kutu Mt./Ad. | Koli Adet | Fiyat (₺) |
|-----------|----------|--------------|-----------|-----------|
|-----------|----------|--------------|-----------|-----------|

### PLASTİK KASA - BUAT - TAKOZLAR

|                      |   |         |      |       |
|----------------------|---|---------|------|-------|
| 001 046 130102 00 11 | NORM KASA                                     | 100 ad. | 1000 | 6,67  |
| 001 046 130101 00 11 | NORM BUAT (14-18 ÇIKIŞLI)                     | 50 ad.  | 500  | 14,81 |
| 001 046 130105 00 11 | NORM BUAT KAPAKSIZ                            | 50 ad.  | 500  | 11,20 |
| 001 046 160102 00 11 | GEÇMELİ PLASTİK KASA                          | 100 ad. | 400  | 18,07 |
| 001 046 160101 00 11 | GEÇMELİ DERİN KASA                            | 100 ad. | 500  | 13,33 |
| 001 046 130107 00 11 | GEÇMELİ DERİN KASA KAPAKSIZ                   | 100 ad. | 500  | 9,44  |
| 001 046 180101 00 11 | ÇİFT KİLİTLEMELİ GEÇMELİ DERİN KASA SİYAH     | 75 ad.  | 300  | 34,07 |
| 001 046 150000 00 11 | GEÇMELİ DERİN KASA UZATMA PARÇASI SİYAH       | 225 ad. | 900  | 11,11 |
| 001 046 120110 00 11 | GEÇMELİ ALÇIPAN KASA (KOLAY BAĞLANTILI) SİYAH | 60 ad.  | 240  | 27,04 |
| 001 046 120101 00 11 | ALÇIPAN KASA 1'Lİ                             | 75 ad.  | 300  | 40,07 |
| 001 046 120102 00 11 | ALÇIPAN KASA 2'Lİ                             | 50 ad.  | 200  | 58,58 |
| 001 046 120103 00 11 | ALÇIPAN KASA 3'Lİ                             | 25 ad.  | 100  | 84,06 |
| 001 046 120100 00 11 | GEÇMELİ ALÇIPAN KASA - SİYAH                  | 50 ad.  | 300  | 25,46 |
| 001 046 000001 00 11 | PLASTİK TAKOZ (14-18 ÇIKIŞLI)                 | 100 ad. | 1000 | 11,01 |

### TURUNCU KASA VE BUATLAR - HALOJEN FREE - ALEV YAYAN

|                      |  |         |      |       |
|----------------------|--|---------|------|-------|
| 001 046 130202 00 12 | NORM KASA (TURUNCU) (HALOJEN FREE) (ALEV YAYAN)          | 100 ad. | 1000 | 12,81 |
| 001 046 130201 00 12 | NORM BUAT (TURUNCU) (HALOJEN FREE) (ALEV YAYAN)          | 50 ad.  | 500  | 21,67 |
| 001 046 160201 00 12 | GEÇMELİ DERİN KASA (TURUNCU) (HALOJEN FREE) (ALEV YAYAN) | 100 ad. | 500  | 24,07 |

### TURUNCU KASA VE BUATLAR - ALEV YAYAN

|                      |   |         |      |       |
|----------------------|---|---------|------|-------|
| 001 046 130102 00 12 | NORM KASA (TURUNCU)(ALEV YAYAN)                 | 100 ad. | 1000 | 9,48  |
| 001 046 130101 00 12 | NORM BUAT (TURUNCU)(ALEV YAYAN)                 | 50 ad.  | 500  | 18,96 |
| 001 046 160102 00 12 | GEÇMELİ PLASTİK KASA (TURUNCU)(ALEV YAYAN)      | 100 ad. | 400  | 21,85 |
| 001 046 160101 00 12 | GEÇMELİ DERİN KASA (TURUNCU)(ALEV YAYAN)        | 100 ad. | 500  | 22,22 |
| 001 046 180101 00 12 | ÇİFT KİLİTLEMELİ GEÇMELİ DERİN KASA TURUNCU     | 75 ad.  | 300  | 34,26 |
| 001 046 150000 00 12 | GEÇMELİ DERİN KASA UZATMA PARÇASI TURUNCU       | 225 ad. | 900  | 11,44 |
| 001 046 120110 00 12 | GEÇMELİ ALÇIPAN KASA (KOLAY BAĞLANTILI) TURUNCU | 60 ad.  | 240  | 29,86 |
| 001 046 120101 00 12 | ALÇIPAN KASA 1'Lİ (TURUNCU)(ALEV YAYAN)         | 75 ad.  | 300  | 42,30 |
| 001 046 120102 00 12 | ALÇIPAN KASA 2'Lİ (TURUNCU)(ALEV YAYAN)         | 50 ad.  | 200  | 62,52 |
| 001 046 120103 00 12 | ALÇIPAN KASA 3'LÜ (TURUNCU)(ALEV YAYAN)         | 25 ad.  | 100  | 89,16 |
| 001 046 120100 00 12 | GEÇMELİ ALÇIPAN KASA (TURUNCU)(ALEV YAYAN)      | 50 ad.  | 300  | 26,39 |

001 046 130101 00 11

001 046 130102 00 12

001 046 130102 00 11

001 046 130107 00 11

001 046 160101 00 12

001 046 150001 00 11

001 046 180101 00 11

001 046 180101 00 12

001 046 120110 00 12

001 046 120102 00 12

001 046 120101 00 12

001 046 120103 00 12

001 046 120100 00 12

| Ürün Kodu                                      | Ürün Adı  | Kutu Adet | Koli Adet | Fiyat (₺) |
|--|---|-----------|-----------|-----------|
| <b>TURUNCU KASA VE BUATLAR - ALEV YAYMAYAN</b> |   |           |           |           |
| 001 046 131102 00 12                           | NORM KASA (TURUNCU)(ALEV YAYMAYAN)                      | 100 ad.   | 1000      | 11,38     |
| 001 046 131101 00 12                           | NORM BUAT (TURUNCU)(ALEV YAYMAYAN)                      | 50 ad.    | 500       | 21,70     |
| 001 046 161102 00 12                           | GEÇMELİ PLASTİK KASA (TURUNCU)(ALEV YAYMAYAN)           | 100 ad.   | 400       | 42,27     |
| 001 046 161101 00 12                           | GEÇMELİ DERİN KASA (TURUNCU)(ALEV YAYMAYAN)             | 100 ad.   | 500       | 26,20     |
| 001 046 181101 00 12                           | ÇİFT KİLİTLEMELİ GEÇMELİ DERİN KASA TURUNCU             | 75 ad.    | 300       | 27,04     |
| 001 046 181201 00 12                           | ÇİFT KİLİT. GEÇ. DERİN KASA TURUNCU A.YAYMAYAN (H.FREE) | 75 ad.    | 300       | 49,26     |
| 001 046 150001 00 12                           | GEÇMELİ DERİN KASA UZATMA PARÇASI TURUNCU               | 225 ad.   | 900       | 22,22     |
| 001 046 121101 00 12                           | ALÇIPAN KASA 1'Lİ (TURUNCU)(ALEV YAYMAYAN)              | 75 ad.    | 300       | 51,60     |
| 001 046 121102 00 12                           | ALÇIPAN KASA 2'Lİ (TURUNCU)(ALEV YAYMAYAN)              | 50 ad.    | 200       | 76,67     |
| 001 046 121103 00 12                           | ALÇIPAN KASA 3'LÜ (TURUNCU)(ALEV YAYMAYAN)              | 25 ad.    | 100       | 108,45    |
| 001 046 121100 00 12                           | GEÇMELİ ALÇIPAN KASA (TURUNCU)(ALEV YAYMAYAN)           | 50 ad.    | 300       | 32,59     |

### KARE BUAT

|                      |                                    |        |     |        |
|----------------------|------------------------------------|--------|-----|--------|
| 001 046 021010 00 11 | 10X10 KARE BUAT (SİYAH)            | 10 ad. | 300 | 152,32 |
| 001 046 021212 00 11 | 12X12 KARE BUAT (SİYAH)            | 10 ad. | 200 | 153,69 |
| 001 046 021515 00 11 | 15X15 KARE BUAT (SİYAH)            | 10 ad. | 120 | 208,35 |
| 001 046 022020 00 11 | 20X20 KARE BUAT (SİYAH)            | 10 ad. | 70  | 245,17 |
| 001 046 000103 00 11 | ANTİGRON BUAT 3'LÜ PLASTİK (SİYAH) | 10 ad. | 240 | 107,41 |
| 001 046 000104 00 11 | ANTİGRON BUAT 4'LÜ PLASTİK (SİYAH) | 10 ad. | 240 | 122,22 |
| 001 046 000103 00 00 | ANTİGRON BUAT 3'LÜ PLASTİK (BEYAZ) | 10 ad. | 240 | 107,41 |
| 001 046 000104 00 00 | ANTİGRON BUAT 4'LÜ PLASTİK (BEYAZ) | 10 ad. | 240 | 122,22 |
| 001 046 021010 00 12 | 10X10 KARE BUAT TURUNCU            | 10 ad. | 300 | 159,94 |
| 001 046 021212 00 12 | 12X12 KARE BUAT TURUNCU            | 10 ad. | 200 | 161,37 |
| 001 046 021515 00 12 | 15X15 KARE BUAT TURUNCU            | 10 ad. | 120 | 218,77 |
| 001 046 022020 00 12 | 20X20 KARE BUAT TURUNCU            | 10 ad. | 70  | 257,43 |
| 001 046 000103 00 12 | ANTİGRON BUAT 3'LÜ TURUNCU         | 10 ad. | 240 | 120,11 |
| 001 046 000104 00 12 | ANTİGRON BUAT 4'LÜ TURUNCU         | 10 ad. | 240 | 136,62 |

### TURUNCU KARE BUAT - ALEV YAYMAYAN

|                      |  |        |     |        |
|----------------------|--|--------|-----|--------|
| 001 046 051010 00 12 | KARE BUAT TURUNCU(10X10) (ALEV YAYMAYAN) | 10 ad. | 300 | 167,93 |
| 001 046 051212 00 12 | KARE BUAT TURUNCU(12X12) (ALEV YAYMAYAN) | 10 ad. | 200 | 169,44 |
| 001 046 051515 00 12 | KARE BUAT TURUNCU(15X15) (ALEV YAYMAYAN) | 10 ad. | 120 | 240,74 |
| 001 046 052020 00 12 | KARE BUAT TURUNCU(20X20) (ALEV YAYMAYAN) | 10 ad. | 70  | 296,30 |

### LÜKS BUAT KAPAKLARI

|                |  |         |      |       |
|----------------|--|---------|------|-------|
| 126 046 180001 | LÜKS BUAT KAPAĞI (BOMBELİ-PLASTİK AYAK)        | 100 ad. | 1000 | 8,00  |
| 126 046 180003 | LÜKS BUAT KAPAĞI (DÜZ - PLASTİK AYAK)          | 100 ad. | 1000 | 8,00  |
| 126 046 180004 | LÜKS BUAT KAPAĞI (BOMBELİ PLASTİK AYAK )VİDALI | 100 ad. | 1000 | 22,22 |

### KARE BUAT KAPAKLARI

|                      |                        |       |     |       |
|----------------------|------------------------|-------|-----|-------|
| 000 700 000043 00 00 | 10X10 KARE BUAT KAPAĞI | 1 ad. | 300 | 27,78 |
| 000 700 000045 00 00 | 12X12 KARE BUAT KAPAĞI | 1 ad. | 350 | 31,48 |
| 000 700 000047 00 00 | 15X15 KARE BUAT KAPAĞI | 1 ad. | 260 | 46,30 |
| 000 700 000049 00 00 | 20X20 KARE BUAT KAPAĞI | 1 ad. | 140 | 77,78 |



001 046 1210102 00 12

001 046 120101 00 12



001 046 121103 00 12



001 046 121100 00 12



001 046 021212 00 11



001 046 021212 00 12



001 046 000103 00 00



001 046 000103 00 11

126 046 180003



126 046 180001

126 046 180004



000 700 000047 00 00

| Ürün Kodu                      | Ürün Adı                               | Kutu Adet | Koli Adet | Fiyat (₺) |
|--------------------------------|--|-----------|-----------|-----------|
| <b>GALVANİZLİ SAC KROŞELER</b> |  |           |           |           |
| 001 048 060001 00 00           | NO. 1 TEKLİ GALVANİZ SAC KROŞE 12 mm   | 1500 ad.  |           | 4,17      |
| 001 048 060002 00 00           | NO. 2 TEKLİ GALVANİZ SAC KROŞE 14 mm   | 1000 ad.  |           | 4,33      |
| 001 048 060003 00 00           | NO. 3 TEKLİ GALVANİZ SAC KROŞE 17 mm   | 700 ad.   |           | 4,62      |
| 001 048 060004 00 00           | NO. 4 TEKLİ GALVANİZ SAC KROŞE 20 mm   | 500 ad.   |           | 5,02      |
| 001 048 060007 00 00           | NO. 7 TEKLİ GALVANİZ SAC KROŞE 26 mm   | 350 ad.   |           | 6,13      |
| 001 048 060008 00 00           | NO. 8 TEKLİ GALVANİZ SAC KROŞE 34 mm   | 250 ad.   |           | 16,40     |
| 001 048 060009 00 00           | NO. 9 TEKLİ GALVANİZ SAC KROŞE 43 mm   | 200 ad.   |           | 18,60     |
| 001 048 060010 00 00           | NO. 10 TEKLİ GALVANİZ SAC KROŞE 53 mm  | 150 ad.   |           | 19,86     |
| 001 048 060011 00 00           | NO. 11 TEKLİ GALVANİZ SAC KROŞE 55 mm  | 120 ad.   |           | 22,13     |
| 001 048 070002 00 00           | NO. 2 ÇİFTLİ GALVANİZ SAC KROŞE 13 mm  | 600 ad.   |           | 4,64      |
| 001 048 070003 00 00           | NO. 3 ÇİFTLİ GALVANİZ SAC KROŞE 16 mm  | 500 ad.   |           | 5,34      |
| 001 048 070004 00 00           | NO. 4 ÇİFTLİ GALVANİZ SAC KROŞE 22 mm  | 400 ad.   |           | 5,41      |
| 001 048 070007 00 00           | NO. 7 ÇİFTLİ GALVANİZ SAC KROŞE 25 mm  | 400 ad.   |           | 6,38      |
| 001 048 070008 00 00           | NO. 8 ÇİFTLİ GALVANİZ SAC KROŞE 35 mm  | 300 ad.   |           | 16,67     |
| 001 048 070009 00 00           | NO. 9 ÇİFTLİ GALVANİZ SAC KROŞE 45 mm  | 200 ad.   |           | 18,89     |
| 001 048 070010 00 00           | NO. 10 ÇİFTLİ GALVANİZ SAC KROŞE 50 mm | 150 ad.   |           | 20,00     |
| Ürün Kodu                      | Ürün Adı                               | Kutu Adet | Koli Adet | Fiyat (₺) |

**MUTLUSAN BETON ÇİVİLİ KROŞELER**

|                |   |          |       |      |
|----------------|---|----------|-------|------|
| 032 048 070000 | NO:0 BETON ÇİVİLİ KROŞE (0.75 YASSI KORDON) | 1000 ad. | 20000 | 0,93 |
| 032 048 070001 | NO:1 BETON ÇİVİLİ KROŞE (0.75 YASSI KORDON) | 1000 ad. | 20000 | 0,93 |
| 032 048 070002 | NO:2 BETON ÇİVİLİ KROŞE (0.75 YASSI KORDON) | 1000 ad. | 20000 | 0,93 |
| 032 048 070003 | NO:3 BETON ÇİVİLİ KROŞE (2X1.5-3X1.5)       | 1000 ad. | 20000 | 1,26 |
| 032 048 070004 | NO:4 BETON ÇİVİLİ KROŞE (2X4)               | 1000 ad. | 20000 | 1,26 |
| 032 048 070005 | NO:5 BETON ÇİVİLİ KROŞE (2X4-4X4)           | 1000 ad. | 10000 | 1,74 |
| 032 048 070006 | NO:6 BETON ÇİVİLİ KROŞE (2X6)               | 1000 ad. | 10000 | 2,11 |
| 032 048 070007 | NO:7 BETON ÇİVİLİ KROŞE (4X10)              | 1000 ad. | 5000  | 3,15 |
| 032 048 070008 | NO:8 BETON ÇİVİLİ KROŞE (3X16+10)           | 800 ad.  | 3200  | 4,81 |

**RAY KROŞE VE TANDIR KROŞELER**

|                      |                                |         |  |        |
|----------------------|--------------------------------|---------|--|--------|
| 035 048 100001       | NO. 1 RAY KROŞE (2X1.5-4X2.5)  | 350 ad. |  | 15,74  |
| 035 048 100002       | NO. 2 RAY KROŞE (4X4-4X16)     | 250 ad. |  | 17,59  |
| 001 025 010100 00 00 | GALVANİZ KROŞE RAYI (1 Metre)  | 50 ad.  |  | 111,11 |
| 035 048 110001       | NO. 1 TANDIR KROŞE (2X1.5-2X6) | 350 ad. |  | 15,74  |
| 035 048 110002       | NO. 2 TANDIR KROŞE (4X6)       | 250 ad. |  | 15,74  |
| 035 048 110003       | NO. 3 TANDIR KROŞE (4X10)      | 250 ad. |  | 15,74  |
| 035 048 110004       | NO. 4 TANDIR KROŞE (4X16)      | 150 ad. |  | 20,37  |
| 035 048 110005       | NO. 5 TANDIR KROŞE (3X25+16)   | 150 ad. |  | 20,37  |

**PLASTİK DÜBELLER**

|                      |                        |          |       |      |
|----------------------|------------------------|----------|-------|------|
| 016 053 000014       | BURGULU ALÇIPAN DÜBELİ | 100 ad.  | 10000 | 1,37 |
| 001 053 000001 00 00 | ALÇIPAN DÜBEL          | 100 ad.  | 10000 | 0,94 |
| 001 053 000002 00 00 | KANAL DÜBELİ           | 1000 ad. | 10000 | 0,75 |
| 016 053 000006       | 6 mm BEYAZ DÜBEL       | 1000 ad. | 50000 | 0,45 |
| 016 053 000007       | 7 mm BEYAZ DÜBEL       | 1000 ad. | 25000 | 0,49 |
| 016 053 000008       | 8 mm BEYAZ DÜBEL       | 1000 ad. | 25000 | 0,50 |

**DÜBELLİ KROŞELER**

|                      |                               |         |       |      |
|----------------------|-------------------------------|---------|-------|------|
| 001 048 090002 00 17 | 3/13 TEKLİ KABLO KROŞESİ      | 500 ad. | 10000 | 1,44 |
| 001 048 090006 00 17 | 8/28 TEKLİ KABLO KROŞESİ      | 500 ad. | 5000  | 1,94 |
| 001 048 090001 00 00 | ÇİFTLİ KABLO KROŞESİ (20'LİK) | 100 ad. | 8000  | 2,34 |
| 001 048 090002 00 00 | ÇİFTLİ KABLO KROŞESİ (25'LİK) | 250 ad. | 5000  | 2,42 |
| 001 048 090003 00 17 | 16'LİK BORU KELEPÇESİ         | 100 ad. | 2000  | 2,21 |
| 001 048 090004 00 17 | 20'LİK BORU KELEPÇESİ         | 100 ad. | 1500  | 2,60 |
| 001 048 090005 00 17 | 25'LİK BORU KELEPÇESİ         | 100 ad. | 1000  | 3,32 |

**ELEKTRİK İZOLASYON BANTLARI 0.13mm x 19mm x 10yds (9,14m)**

| Ürün Kodu      | Ürün Adı                                | Paket Ad. | Koli Ad. | Fiyat (₺) |
|----------------|---|-----------|----------|-----------|
| 065 133 001019 | PVC ELEKTRİK İZOLE BANDI - SİYAH        | 10        | 500      | 33,33     |
| 065 133 011019 | PVC ELEKTRİK İZOLE BANDI - BEYAZ        | 10        | 500      | 33,33     |
| 065 133 161019 | PVC ELEKTRİK İZOLE BANDI - KIRMIZI      | 10        | 500      | 33,33     |
| 065 133 131019 | PVC ELEKTRİK İZOLE BANDI - MAVİ         | 10        | 500      | 33,33     |
| 065 133 141019 | PVC ELEKTRİK İZOLE BANDI - SARI         | 10        | 500      | 33,33     |
| 065 133 151019 | PVC ELEKTRİK İZOLE BANDI - YEŞİL        | 10        | 500      | 33,33     |
| 065 133 171019 | PVC ELEKTRİK İZOLE BANDI - SARI + YEŞİL | 10        | 500      | 37,04     |



001 053 000002 00 00



016 053 000014

001 053 000001 00 00



# Evinizin ritmi, kapınızda başlasın!



- 32 Farklı Seçilebilir Melodi
- Pil ile Çalışan Dekoratif Kablosuz Kapı Zili
- Algılama Mesafesi: Açık Alanda 100 Mt.
- Diğer Kablosuz Aygıtlarla Karışmayı Önlemek İçin Frekans Filtresi Kodu
- IP44 Led Işıklı, Etiketli Zil Butonu
- Zil Butonu İçin 1x12V 23A Pil
- İç Ünite İçin 3x1.5V AA Pil

\* WA-628 ve WA-638 modellerinin özellikleridir.



888 038 218000



018 105 158100



018 105 114800



018 105 162800



018 105 163800



018 105 162811



018 105 163811

## KAPI ZİLLERİ

| Kod            | Ürün Tanımı   | Kutu Adedi | Koli Adedi | Fiyat (\$) |
|----------------|---|------------|------------|------------|
| 888 038 218000 | Q218 KABLOSUZ KAPI ZİLİ LEDLİ 100 Metre - 32 MELODİ | 1          | 10         | 43,00 \$   |
| 018 105 158100 | X-581 KAPI ZİLİ - 32 MELODİ                         | 1          | 10         | 29,00 \$   |
| 018 105 114800 | A-148 KAPI ZİLİ - 32 MELODİ                         | 1          | 10         | 29,00 \$   |
| 018 105 162800 | WA-628 KAPI ZİLİ - BEYAZ 32 MELODİ                  | 1          | 10         | 36,50 \$   |
| 018 105 162811 | WA-628 KAPI ZİLİ - SİYAH 32 MELODİ                  | 1          | 10         | 36,50 \$   |
| 018 105 163800 | WA-638 KAPI ZİLİ - BEYAZ 32 MELODİ                  | 1          | 10         | 36,50 \$   |
| 018 105 163811 | WA-638 KAPI ZİLİ - SİYAH 32 MELODİ                  | 1          | 10         | 36,50 \$   |



028 105 020003

018 105 000007

027 105 010012

| Ürün Kodu                      | Ürün Adı                            | Kutu Adet | Koli Adet | Fiyat (₺) |
|--------------------------------|-------------------------------------|-----------|-----------|-----------|
| <b>ZİLLER VE ZİL TRAFOLARI</b> |                                     |           |           |           |
| 027 105 010012                 | ZİL TRAFOSU 12V                     | 1 ad.     | 80        | 439,81    |
| 027 105 010015                 | ZİL TRAFOSU 15V                     | 1 ad.     | 40        | 787,04    |
| 028 105 020003                 | KAMPANA ZİL 220V AC                 | 1 ad.     | 24        | 2.037,04  |
| 028 105 020004                 | KAMPANA ZİL 12V AC, 24V AC, 110V AC | 1 ad.     | 24        | 3.009,26  |
| 028 105 020000                 | MUNZAM ZİL ROLESİ                   | 1 ad.     | 100       | 1.365,74  |
| 018 105 000006                 | KANARYA ZİL (TEK SES)               | 1 ad.     | 50        | 231,48    |
| 018 105 000007                 | KANARYA ZİL (ÜÇ SES)                | 1 ad.     | 50        | 254,63    |
| 018 105 000001                 | TELEFON ZİLİ (AYARLI)               | 1 ad.     | 50        | 393,52    |
| 018 105 000002                 | DİNG DONG ZİL ELEKTRONİK (3 SES)    | 1 ad.     | 50        | 296,30    |



027 112 000004



027 112 000007



027 112 000003

| Ürün Kodu                         | Ürün Adı                                      | Kutu Adet | Koli Adet | Fiyat (₺) |
|-----------------------------------|---|-----------|-----------|-----------|
| <b>KAPI VE MERDİVEN OTOMATIĞI</b> |   |           |           |           |
| 027 112 000001                    | GİZLİ KAPI OTOMATIĞI (DOKUNMATİK)             | 1 ad.     | 20        | 1.759,26  |
| 027 112 000002                    | GİZLİ KAPI OTOMATIĞI (BASMATİK)               | 1 ad.     | 20        | 1.759,26  |
| 027 112 000007                    | ELEKTRİKLİ KİLİTLİ (ANAHTARLI) KAPI OTOMATIĞI | 1 ad.     | 12        | 3.009,26  |
| 027 112 000009                    | ELEKTRİKLİ KİLİTLİ KAPI OTOMATIĞI (BİLYELİ)   | 1 ad.     | 12        | 3.009,26  |
| 027 112 000003                    | BUTONLU KAPI OTOMATIĞI                        | 1 ad.     | 30        | 1.250,00  |
| 028 112 000004                    | KAPI OTOMATIĞI (NORMAL)                       | 1 ad.     | 30        | 1.226,85  |
| 027 112 000004                    | BAS-AÇ KAPI OTOMATIĞI (TIRAJLI KİLİT İÇİN)    | 1 ad.     | 30        | 1.851,85  |
| 027 112 000005                    | MERDİVEN OTOMATIĞI (RAYLI)                    | 1 ad.     | 30        | 1.226,85  |
| 027 112 000006                    | MERDİVEN OTOMATIĞI (NORMAL)                   | 1 ad.     | 30        | 1.226,85  |

## YANGIN ALGILAMA ve İKAZ SİSTEMLERİ



028 120 000001

888 111 050004

026 112 010001

028 120 010005

028 120 010006

026 111 010003

010 090 050051

102 111 00220

102 111 000221

| Ürün Kodu                                 | Ürün Adı  | Kutu Adet | Koli Adet | Fiyat (₺) |
|---|---|-----------|-----------|-----------|
| <b>İKAZ KORNASI</b>                       |   |           |           |           |
| 026 112 010001                            | İKAZ KORNASI 220V                                       | 1 ad.     | 45        | 902,78    |
| 028 120 000001                            | İKAZ BUTONU (KARE)                                      | 2 ad.     | 90        | 287,04    |
| <b>ALARM KORNA ve YANGIN İHBAR BUTONU</b> |   |           |           |           |
| 010 090 050050                            | RESELENEBİLİR BUTON                                     | 2 ad.     | 90        | 1.273,15  |
| 010 090 050051                            | RESELENEBİLİR BUTON ( KAPAKLI)                          | 1 ad.     | 90        | 1.412,04  |
| 028 120 010006                            | ALARM KORNA PLASTİK                                     | 1 ad.     | 30        | 1.250,00  |
| 028 120 010005                            | ALARM KORNA DÖKÜM                                       | 1 ad.     | 30        | 1.435,19  |
| <b>SİRENLER</b>                           |   |           |           |           |
| 102 111 000012                            | LEDLİ FLAŞÖRLÜ ELEKTRONİK SİREN 12V                     | 1 ad.     | 25        | 638,89    |
| 102 111 000024                            | LEDLİ FLAŞÖRLÜ ELEKTRONİK SİREN 24V                     | 1 ad.     | 25        | 638,89    |
| 102 111 000220                            | LEDLİ FLAŞÖRLÜ ELEKTRONİK SİREN 220V                    | 1 ad.     | 25        | 671,30    |
| 102 111 000221                            | LEDLİ FLAŞÖRLÜ ELEKTRONİK SİREN 220V (YENİ MODEL)       | 1 ad.     | 30        | 925,93    |
| 888 111 050004                            | MS190 MİNİ SİREN (105 db)                               | 1 ad.     | 40        | 15,50 \$  |
| 026 111 010001                            | AS.1 MOTORLU SİREN (PLASTİK GÖVDE) 220V, 100W (110 db.) | 1 ad.     | 20        | 2.662,04  |
| 026 111 010002                            | AS.2 MOTORLU SİREN (PLASTİK GÖVDE) 220V, 100W (117 db.) | 1 ad.     | 12        | 2.893,52  |
| 026 111 010003                            | AS.1 MOTORLU SİREN (METAL GÖVDE) 220V, 100W (115 db.)   | 1 ad.     | 20        | 3.125,00  |
| 026 111 010004                            | AS.2 MOTORLU SİREN (METAL GÖVDE) 220V, 100W (120 db.)   | 1 ad.     | 12        | 3.958,33  |
| 026 111 010005                            | AS.3 MOTORLU SİREN 220V-280W (130 db.)                  | 1 ad.     | -         | 26.157,41 |

## KAPALI TİP BANYO ASPİRATÖRLERİ

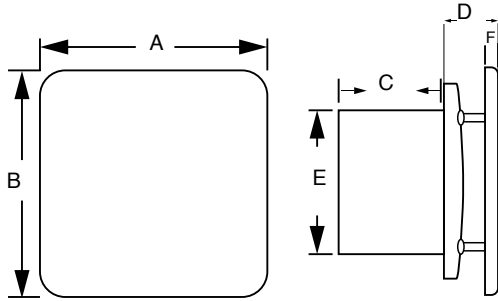

| Ürün Kodu            | Ürün Adı                                 | Güç (W) | Emiş Hacmi (m <sup>3</sup> /h) | Devir hızı (rpm) | Ses (dB) | Ölçüler (mm) |     |    |    |     | Kutu /Koli Adet | Fiyat (₺) |
|----------------------|--|---------|--------------------------------|------------------|----------|--------------|-----|----|----|-----|-----------------|-----------|
|                      |  |         |                                |                  |          | A            | B   | C  | D  | E   |                 |           |
| 001 211 100100 00 00 | ME-FAN 100 KAPALI TİP ASPİRATÖR BEYAZ    | 12W     | 100 m <sup>3</sup> /h          | 2450 rpm         | 43 dB    | 180          | 180 | 60 | 35 | 100 | 1/20            | 816,67    |
| 001 211 100100 00 19 | ME-FAN 100 KAPALI TİP ASPİRATÖR ANTRASİT | 12W     | 100 m <sup>3</sup> /h          | 2450 rpm         | 43 dB    | 180          | 180 | 60 | 35 | 100 | 1/20            | 1.166,67  |
| 001 211 100120 00 00 | ME-FAN 120 KAPALI TİP ASPİRATÖR BEYAZ    | 15W     | 120 m <sup>3</sup> /h          | 1900 rpm         | 47 dB    | 215          | 215 | 65 | 45 | 120 | 1/20            | 863,33    |
| 001 211 100120 00 19 | ME-FAN 120 KAPALI TİP ASPİRATÖR ANTRASİT | 15W     | 120 m <sup>3</sup> /h          | 1900 rpm         | 47 dB    | 215          | 215 | 65 | 45 | 120 | 1/20            | 1.353,33  |
| 001 211 100150 00 00 | ME-FAN 150 KAPALI TİP ASPİRATÖR BEYAZ    | 20W     | 150 m <sup>3</sup> /h          | 1350 rpm         | 47 dB    | 260          | 260 | 80 | 40 | 150 | 1/12            | 1.213,33  |
| 001 211 100150 00 19 | ME-FAN 150 KAPALI TİP ASPİRATÖR ANTRASİT | 20W     | 150 m <sup>3</sup> /h          | 1350 rpm         | 47 dB    | 260          | 260 | 80 | 40 | 150 | 1/12            | 1.703,33  |

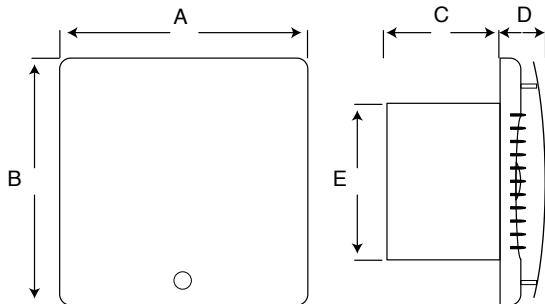

| Ürün Kodu            | Ürün Adı                        | Güç (W) | Emiş Hacmi (m <sup>3</sup> /h) | Devir hızı (rpm) | Ses (dB) | Ölçüler (mm) |     |    |    |     | Kutu /Koli Adet | Fiyat (₺) |
|----------------------|---------------------------------|---------|--------------------------------|------------------|----------|--------------|-----|----|----|-----|-----------------|-----------|
|                      |                                 |         |                                |                  |          | A            | B   | C  | D  | E   |                 |           |
| 001 111 100100 00 00 | DEKORA 100 KAPALI TİP ASPİRATÖR | 12W     | 100 m <sup>3</sup> /h          | 2450 rpm         | 43 dB    | 158          | 158 | 72 | 29 | 100 | 1/20            | 925,93    |

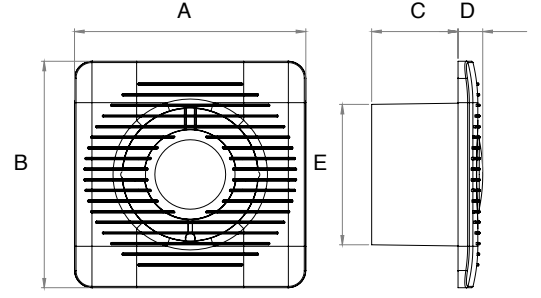

220-240V / 50-60Hz

## ME-FAN BANYO ASPİRATÖLERİ

| Ürün Kodu            | Ürün Adı             | Güç (W) | Emiş Hacmi (m <sup>3</sup> /h) | Devir hızı (rpm) | Ses (dB) | Ölçüler (mm) |     |    |      |     | Kutu /Koli Adet | Fiyat (₺) |
|----------------------|----------------------|---------|--------------------------------|------------------|----------|--------------|-----|----|------|-----|-----------------|-----------|
|                      |                      |         |                                |                  |          | A            | B   | C  | D    | E   |                 |           |
| 001 211 000100 00 00 | ME-FAN 100 ASPİRATÖR | 12W     | 100 m <sup>3</sup> /h          | 2450 rpm         | 43 dB    | 158          | 158 | 60 | 17   | 100 | 1/20            | 686,00    |
| 001 211 000120 00 00 | ME-FAN 120 ASPİRATÖR | 15W     | 120 m <sup>3</sup> /h          | 1900 rpm         | 47 dB    | 180          | 180 | 65 | 20   | 120 | 1/20            | 714,00    |
| 001 211 000150 00 00 | ME-FAN 150 ASPİRATÖR | 20W     | 150 m <sup>3</sup> /h          | 1350 rpm         | 47 dB    | 222          | 222 | 80 | 22,5 | 150 | 1/12            | 1.073,33  |
| 001 211 000200 00 00 | ME-FAN 200 ASPİRATÖR | 40W     | 200 m <sup>3</sup> /h          | 1200 rpm         | 55 dB    | 260          | 260 | 90 | 13   | 200 | 1/6             | 1.726,67  |

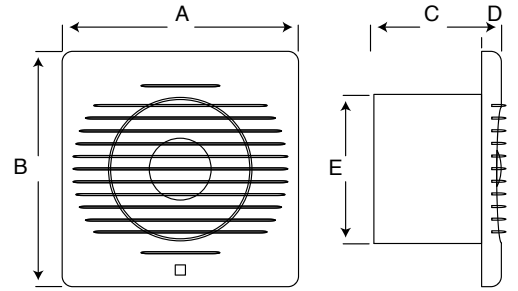

220-240V / 50-60Hz

## MUTLUSAN BANYO ASPİRATÖLERİ

| Ürün Kodu            | Ürün Adı                   | Güç (W) | Emiş Hacmi (m <sup>3</sup> /h) | Devir hızı (rpm) | Ses (dB) | Ölçüler (mm) |     |    |    |     | Kutu /Koli Adet | Fiyat (₺) |
|----------------------|----------------------------|---------|--------------------------------|------------------|----------|--------------|-----|----|----|-----|-----------------|-----------|
|                      |                            |         |                                |                  |          | A            | B   | C  | D  | E   |                 |           |
| 001 111 000100 00 00 | MUTLUSAN AIR 100 ASPİRATÖR | 12W     | 100 m <sup>3</sup> /h          | 2450 rpm         | 43 dB    | 158          | 158 | 85 | 13 | 100 | 1/20            | 777,78    |
| 001 111 000120 00 00 | MUTLUSAN AIR 120 ASPİRATÖR | 15W     | 120 m <sup>3</sup> /h          | 1900 rpm         | 47 dB    | 175          | 175 | 85 | 13 | 120 | 1/20            | 814,81    |
| 001 111 000150 00 00 | MUTLUSAN AIR 150 ASPİRATÖR | 20W     | 150 m <sup>3</sup> /h          | 1350 rpm         | 47 dB    | 205          | 205 | 85 | 13 | 150 | 1/16            | 1.185,19  |
| 001 111 000200 00 00 | MUTLUSAN AIR 200 ASPİRATÖR | 40W     | 200 m <sup>3</sup> /h          | 1000 rpm         | 55 dB    | 260          | 260 | 90 | 13 | 200 | 1/6             | 2.037,04  |



Bluetooth™

Uzaktan Kumandalı 

- 52cm pervane
- Düşük enerjili yüksek verimli motor
- İki yönlü fan çalışma özelliği
- Uzaktan kumanda
- 6 ayarlanabilir hız seçeneği
- Zaman ayarı
- Işık parlaklığı ve 3 renk ayarı  
(beyaz - gün ışığı - soğuk beyaz)
- Bluetooth - müzik fonksiyonu
- Hoparlör
- LED aydınlatma

## AYDINLATMALI TAVAN VANTİLATÖRÜ (BLUETOOTHLU)

| Ürün Kodu            | Ürün Adı   | Kutu Adedi | Fiyat (₺) |
|----------------------|--|------------|-----------|
| 001 038 300100 00 00 | AYDINLATMALI TAVAN VANTİLATÖRÜ (BLUETOOTHLU) - BÜYÜK BOY - 52 cm | 1          | 15.500,00 |



## EXIT - ACİL AYDINLATMA ARMATÜRLERİ (LEDLİ) - IP20 CE



102 038 0008XX - CEXA

**FİYAT : 986,11 ₺**

- \*GÖVDE : ABS
- \*CAM : Polistren (PS) isteğe bağlı Akrilik(PMMA) veya Polycarbon(PC)
- \*BASKI : Akrilik Işık geçirgen Translucent Folyo
- \*ÇALIŞMA : Acil de ve Şebeke de sürekli çalışma
- \*PİL : 3.6V 80mAH NİMH (NikelMethalhidrid)
- \*ŞARJ SÜRESİ : 14-20 Saat
- \*DEŞARJ SÜRESİ : 180 Dk
- \*KORUMA SINIFI : IP20
- \*LED : 4.8mm 6000K Beyaz Mantar Led  
veya 2835 6400K EDİSON OPTO SMD Led
- TÜKETİM : 2 Watt

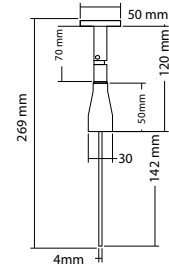
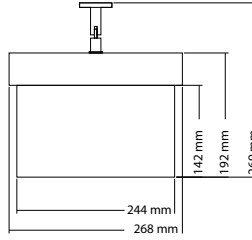

|    |    |    |    |    |    |    |    |
|----|----|----|----|----|----|----|----|
|    |    |    |    |    |    |    |    |
| 01 | 02 | 03 | 04 | 05 | 06 | 07 | 08 |
|    |    |    |    |    |    |    |    |
| 09 | 10 | 11 | 12 | 13 | 14 |    |    |
|    |    |    |    |    |    |    |    |
| 15 | 16 | 17 | 18 | 19 | 20 |    |    |
|    |    |    |    |    |    |    |    |
| 21 | 22 | 23 | 24 | 25 | 26 |    |    |
|    |    |    |    |    |    |    |    |
| 27 | 28 | 29 | 30 | 31 | 32 |    |    |
|    |    |    |    |    |    |    |    |
| 33 | 34 | 35 | 36 |    |    |    |    |
|    |    |    |    |    |    |    |    |
| 37 | 38 | 39 | 40 | 41 | 42 | 43 |    |
|    |    |    |    |    |    |    |    |
| 44 | 45 | 46 | 47 | 48 | 49 | 50 | 51 |
|    |    |    |    |    |    |    |    |
| 52 | 53 | 54 | 55 | 56 | 57 | 58 | 59 |
|    |    |    |    |    |    |    |    |
| 60 | 61 | 62 | 63 | 64 | 65 |    |    |

\*Sipariş Verdiğiniz Ürünün Sembol Kodunu Yazmayı Unutmayınız.

\*Ürün Kodunun Son 2 hanesi olan XX Rakamları Ürünün Sembol Kodunu belirtmektedir.

## LED ARMATÜR ÇEŞİTLERİ



|               |                       |                |
|---------------|-----------------------|----------------|
| Renk          | BEYAZ                 | SİYAH          |
| Ürün Kodu     | 016 038 701500        | 016 038 701511 |
| Ürün Adı      | LED GLOP ARMATÜR IP20 |                |
| Lümen/Watt    | 2000Lm/20W            |                |
| Kelvin        | 6400K                 |                |
| Kutu/Koli Ad. | 24                    |                |
| Fiyat (₺)     | 607,64                |                |

|               |                              |  |
|---------------|------------------------------|--|
| Ürün Kodu     | 016 038 701522               |  |
| Ürün Adı      | LED GLOP ARMATÜR KROM - IP20 |  |
| Lümen/Watt    | 2000Lm/20W                   |  |
| Kelvin        | 6400K                        |  |
| Kutu/Koli Ad. | 24                           |  |
| Fiyat (₺)     | 753,47                       |  |



IP65

|               |                                       |  |
|---------------|---------------------------------------|--|
| Ürün Kodu     | 016 038 701700                        |  |
| Ürün Adı      | 18W NEMLİYER LED OVAL ARMATÜR - BEYAZ |  |
| Lümen/Watt    | 1900Lm/18W                            |  |
| Kelvin        | 6400K                                 |  |
| Kutu/Koli Ad. | 1/40                                  |  |
| Fiyat (₺)     | 704,86                                |  |



IP65

|               |                                    |  |
|---------------|------------------------------------|--|
| Ürün Kodu     | 016 038 701600                     |  |
| Ürün Adı      | 22W NEMLİYER LED GLOP ARM. - BEYAZ |  |
| Lümen/Watt    | 2340Lm/22W                         |  |
| Kelvin        | 6400K                              |  |
| Kutu/Koli Ad. | 1/40                               |  |
| Fiyat (₺)     | 704,86                             |  |



IP65

|               |                          |                |
|---------------|--------------------------|----------------|
| Renk          | BEYAZ                    | SİYAH          |
| Ürün Kodu     | 016 038 701100           | 016 038 701111 |
| Ürün Adı      | LEDLIGHT-1 LEDLİ ARMATÜR |                |
| Lümen/Watt    | 1500Lm/15W               |                |
| Kelvin        | 6400K                    |                |
| Kutu/Koli Ad. | 30                       |                |
| Fiyat (₺)     | 351,85                   |                |



IP65

|               |                       |                |
|---------------|-----------------------|----------------|
| Renk          | BEYAZ                 | SİYAH          |
| Ürün Kodu     | 016 038 701200        | 016 038 701211 |
| Ürün Adı      | LEDLIGHT-2 LEDLİ ARM. |                |
| Lümen/Watt    | 2000Lm/20W            |                |
| Kelvin        | 6400K                 |                |
| Kutu/Koli Ad. | 20                    |                |
| Fiyat (₺)     | 370,37                |                |



IP65

|               |                          |                |
|---------------|--------------------------|----------------|
| Renk          | BEYAZ                    | SİYAH          |
| Ürün Kodu     | 016 038 701300           | 016 038 701311 |
| Ürün Adı      | LEDLIGHT-3 LEDLİ ARMATÜR |                |
| Lümen/Watt    | 1500Lm/15W               |                |
| Kelvin        | 6400K                    |                |
| Kutu/Koli Ad. | 30                       |                |
| Fiyat (₺)     | 425,93                   |                |



IP65

|               |                       |                |
|---------------|-----------------------|----------------|
| Renk          | BEYAZ                 | SİYAH          |
| Ürün Kodu     | 016 038 701400        | 016 038 701411 |
| Ürün Adı      | LEDLIGHT-4 LEDLİ ARM. |                |
| Lümen/Watt    | 2000Lm/20W            |                |
| Kelvin        | 6400K                 |                |
| Kutu/Koli Ad. | 20                    |                |
| Fiyat (₺)     | 481,48                |                |



Max: 26W



|               |                                |  |
|---------------|--------------------------------|--|
| Ürün Kodu     | 016 038 250085                 |  |
| Ürün Adı      | ÇINAR DUVAR APLİK PLASTİK SOFT |  |
| Kutu/Koli Ad. | 1/24                           |  |
| Fiyat (₺)     | 947,92                         |  |



Max: 26W



|               |                                 |  |
|---------------|---------------------------------|--|
| Ürün Kodu     | 078 039 500100                  |  |
| Ürün Adı      | SENSÖRLÜ DUVAR APLİK E-27 DUYLU |  |
| Kutu/Koli Ad. | 1/20                            |  |
| Fiyat (₺)     | 947,92                          |  |



CE

|               |                                      |  |
|---------------|--------------------------------------|--|
| Ürün Kodu     | 001 038 250026 00 00                 |  |
| Ürün Adı      | SENSÖRLÜ GLOP ARMATÜRÜ 2XE27 PLASTİK |  |
| Kutu/Koli Ad. | 1/12                                 |  |
| Fiyat (₺)     | 777,78                               |  |



CE

|               |                                      |  |
|---------------|--------------------------------------|--|
| Ürün Kodu     | 001 038 250027 00 00                 |  |
| Ürün Adı      | SENSÖRLÜ GLOP ARMATÜRÜ LEDLİ PLASTİK |  |
| Kutu/Koli Ad. | 1/12                                 |  |
| Fiyat (₺)     | 1.186,11                             |  |



CE

|               |                                      |  |
|---------------|--------------------------------------|--|
| Ürün Kodu     | 001 038 250022 00 00                 |  |
| Ürün Adı      | 360° SENSÖRLÜ TAVAN ARMATÜRÜ (2x25W) |  |
| Kutu/Koli Ad. | 1/12                                 |  |
| Fiyat (₺)     | 991,67                               |  |

## ARMATÜR ÇEŞİTLERİ



|               |                           |                |
|---------------|---------------------------|----------------|
| Renk          | BEYAZ                     | SİYAH          |
| Ürün Kodu     | 016 038 411110            | 016 038 411120 |
| Ürün Adı      | AQUA KAFESLİ APLİK - IP65 |                |
| Kutu/Koli Ad. | 1/20                      |                |
| Fiyat (₺)     | 402,78                    |                |



CE

|               |                           |                |
|---------------|---------------------------|----------------|
| Renk          | BEYAZ                     | SİYAH          |
| Ürün Kodu     | 016 038 700300            | 016 038 700311 |
| Ürün Adı      | DOLUNAY OPAK APLİK - IP54 |                |
| Kutu/Koli Ad. | 1/20                      |                |
| Fiyat (₺)     | 493,52                    |                |



CE

|               |                             |                |
|---------------|-----------------------------|----------------|
| Renk          | BEYAZ                       | SİYAH          |
| Ürün Kodu     | 016 038 411300              | 016 038 411311 |
| Ürün Adı      | OPAK KAFESLİ ARMATÜR - IP54 |                |
| Kutu/Koli Ad. | 1/24                        |                |
| Fiyat (₺)     | 438,89                      |                |



CE

|               |                     |                |
|---------------|---------------------|----------------|
| Renk          | BEYAZ               | SİYAH          |
| Ürün Kodu     | 016 038 410500      | 016 038 410511 |
| Ürün Adı      | OPAL ARMATÜR - IP65 |                |
| Kutu/Koli Ad. | 1/10                |                |
| Fiyat (₺)     | 718,98              |                |



|               |                |  |
|---------------|----------------|--|
| Ürün Kodu     | 078 039 100005 |  |
| Ürün Adı      | NERGİS APLİK   |  |
| Kutu/Koli Ad. | 8/64           |  |
| Fiyat (₺)     | 216,32         |  |



CE

|               |                                  |  |
|---------------|----------------------------------|--|
| Ürün Kodu     | 078 039 100006                   |  |
| Ürün Adı      | ÇİFT DUYULU TAVAN ARMATÜR - IP20 |  |
| Kutu/Koli Ad. | 2/32                             |  |
| Fiyat (₺)     | 420,49                           |  |



CE

|               |                       |  |
|---------------|-----------------------|--|
| Ürün Kodu     | 001 038 250018 00 00  |  |
| Ürün Adı      | HAZIR ASKI TİJ TAKIMI |  |
| Kutu/Koli Ad. | 25/300                |  |
| Fiyat (₺)     | 92,59                 |  |



|               |                            |                |
|---------------|----------------------------|----------------|
| Renk          | BEYAZ                      | CEVİZ          |
| Ürün Kodu     | 016 038 250088             | 016 038 250089 |
| Ürün Adı      | İNCİ APLİK - DUVAR ARMATÜR |                |
| Kutu/Koli Ad. | 4/64                       |                |
| Fiyat (₺)     | 216,32                     | 303,82         |



CE

|               |                             |                |
|---------------|-----------------------------|----------------|
| Renk          | BEYAZ                       | SİYAH          |
| Ürün Kodu     | 016 038 700400              | 016 038 700411 |
| Ürün Adı      | DOLUNAY ŞEFFAF APLİK - IP54 |                |
| Kutu/Koli Ad. | 1/20                        |                |
| Fiyat (₺)     | 493,52                      |                |



CE

|               |                           |                |
|---------------|---------------------------|----------------|
| Renk          | BEYAZ                     | SİYAH          |
| Ürün Kodu     | 016 038 410600            | 016 038 410611 |
| Ürün Adı      | ELİPS OPAL ARMATÜR - IP65 |                |
| Kutu/Koli Ad. | 1/10                      |                |
| Fiyat (₺)     | 740,74                    |                |



CE

|               |                     |                |
|---------------|---------------------|----------------|
| Renk          | BEYAZ               | SİYAH          |
| Ürün Kodu     | 016 038 410800      | 016 038 410811 |
| Ürün Adı      | OPAK ARMATÜR - IP65 |                |
| Kutu/Koli Ad. | 1/16                |                |
| Fiyat (₺)     | 510,65              |                |



|               |                    |                |
|---------------|--------------------|----------------|
| Renk          | BEYAZ              | CEVİZ          |
| Ürün Kodu     | 016 038 250086     | 016 038 250087 |
| Ürün Adı      | İNCİ TAVAN ARMATÜR |                |
| Kutu/Koli Ad. | 4/32               |                |
| Fiyat (₺)     | 325,69             | 408,33         |



CE

|               |                               |                      |
|---------------|-------------------------------|----------------------|
| Boyut         | KÜÇÜK                         | BÜYÜK                |
| Ürün Kodu     | 001 038 250016 00 00          | 001 038 250017 00 00 |
| Ürün Adı      | PAPATYA HAZIR ASKI TİJ TAKIMI |                      |
| Kutu/Koli Ad. | 25/275                        | 10/80                |
| Fiyat (₺)     | 92,59                         | 138,89               |



CE

|               |                                 |  |
|---------------|---------------------------------|--|
| Ürün Kodu     | 024 109 010005                  |  |
| Ürün Adı      | YAĞMUR DUY (PLASTİK YANMAZ) E27 |  |
| Kutu/Koli Ad. | 50                              |  |
| Fiyat (₺)     | 60,76                           |  |

## APLİK ÇEŞİTLERİ



CE

|            |                        |
|------------|------------------------|
| Ürün Adı   | ZETA 4'LÜ APLİK - IP64 |
| Ürün Kodu  | 001 038 200102 00 11   |
| Renk       | 3000K                  |
| Lümen/Watt | 480Lm/4W               |
| Kutu Adedi | 1                      |
| Fiyat (\$) | 10,00 \$               |



CE

|            |                        |
|------------|------------------------|
| Ürün Adı   | ZETA 4'LÜ APLİK - IP64 |
| Ürün Kodu  | 001 038 201102 00 11   |
| Renk       | 2R+2B                  |
| Lümen/Watt | 480Lm/4W               |
| Kutu Adedi | 1                      |
| Fiyat (\$) | 10,00 \$               |



CE

|            |                        |
|------------|------------------------|
| Ürün Adı   | ZETA 6'LI APLİK - IP64 |
| Ürün Kodu  | 001 038 200103 00 11   |
| Renk       | 3000K                  |
| Lümen/Watt | 720Lm/6W               |
| Kutu Adedi | 1                      |
| Fiyat (\$) | 10,67 \$               |



CE

|            |                        |
|------------|------------------------|
| Ürün Adı   | ZETA 8'LI APLİK - IP64 |
| Ürün Kodu  | 001 038 201104 00 11   |
| Renk       | 2R+2G+2B+2Y            |
| Lümen/Watt | 960Lm/8W               |
| Kutu Adedi | 1                      |
| Fiyat (\$) | 11,33 \$               |



CE

|            |                        |
|------------|------------------------|
| Ürün Adı   | ZETA 8'LI APLİK - IP64 |
| Ürün Kodu  | 001 038 200104 00 11   |
| Renk       | 3000K                  |
| Lümen/Watt | 960Lm/8W               |
| Kutu Adedi | 1                      |
| Fiyat (\$) | 11,33 \$               |



CE

|            |                         |
|------------|-------------------------|
| Ürün Adı   | ZETA 10'LU APLİK - IP64 |
| Ürün Kodu  | 001 038 201105 00 11    |
| Renk       | 2R+2G+2B+2G+2R          |
| Lümen/Watt | 1200Lm/10W              |
| Kutu Adedi | 1                       |
| Fiyat (\$) | 15,00 \$                |



CE

|            |                         |
|------------|-------------------------|
| Ürün Adı   | ZETA 10'LU APLİK - IP64 |
| Ürün Kodu  | 001 038 200105 00 11    |
| Renk       | 3000K                   |
| Lümen/Watt | 1200Lm/10W              |
| Kutu Adedi | 1                       |
| Fiyat (\$) | 15,00 \$                |



CE

|            |                      |
|------------|----------------------|
| Ürün Adı   | HAPPY APLİK - IP64   |
| Ürün Kodu  | 001 038 200124 00 11 |
| Renk       | 3000K                |
| Lümen/Watt | 660Lm/6W             |
| Kutu Adedi | 1                    |
| Fiyat (\$) | 12,77 \$             |



CE

|            |                         |
|------------|-------------------------|
| Ürün Adı   | KARE KÜÇÜK APLİK - IP44 |
| Ürün Kodu  | 001 038 200108 00 11    |
| Renk       | 3000K                   |
| Lümen/Watt | 500Lm/5W                |
| Kutu Adedi | 1                       |
| Fiyat (\$) | 11,00 \$                |



CE

|            |                         |
|------------|-------------------------|
| Ürün Adı   | KARE BÜYÜK APLİK - IP44 |
| Ürün Kodu  | 001 038 200112 00 11    |
| Renk       | 3000K                   |
| Lümen/Watt | 1200Lm/12W              |
| Kutu Adedi | 1                       |
| Fiyat (\$) | 19,33 \$                |



CE

|            |                      |
|------------|----------------------|
| Ürün Adı   | MİNA APLİK - IP64    |
| Ürün Kodu  | 001 038 200116 00 11 |
| Renk       | 3000K                |
| Lümen/Watt | 1000Lm/10W           |
| Kutu Adedi | 1                    |
| Fiyat (\$) | 11,00 \$             |



CE

|            |                      |
|------------|----------------------|
| Ürün Adı   | MİLA APLİK - IP64    |
| Ürün Kodu  | 001 038 200118 00 11 |
| Renk       | 3000K                |
| Lümen/Watt | 1000Lm/10W           |
| Kutu Adedi | 1                    |
| Fiyat (\$) | 19,33 \$             |

## APLİK ÇEŞİTLERİ



CE

|            |                        |
|------------|------------------------|
| Ürün Adı   | ALYA KÜÇÜK APLİK- IP44 |
| Ürün Kodu  | 001 038 200110 00 11   |
| Renk       | 3000K                  |
| Lümen/Watt | 500Lm/5W               |
| Kutu Adedi | 1                      |
| Fiyat (\$) | 11,00 \$               |



CE

|            |                        |
|------------|------------------------|
| Ürün Adı   | ALYA BÜYÜK APLİK- IP44 |
| Ürün Kodu  | 001 038 200114 00 11   |
| Renk       | 3000K                  |
| Lümen/Watt | 1200Lm/12W             |
| Kutu Adedi | 1                      |
| Fiyat (\$) | 19,33 \$               |



CE

|            |                      |
|------------|----------------------|
| Ürün Adı   | PERA APLİK - IP64    |
| Ürün Kodu  | 001 038 200120 00 11 |
| Renk       | 3000K                |
| Lümen/Watt | 660Lm/6W             |
| Kutu Adedi | 1                    |
| Fiyat (\$) | 13,14 \$             |



CE

|            |                      |
|------------|----------------------|
| Ürün Adı   | HERA APLİK - IP64    |
| Ürün Kodu  | 001 038 200122 00 11 |
| Renk       | 3000K                |
| Lümen/Watt | 660Lm/6W             |
| Kutu Adedi | 1                    |
| Fiyat (\$) | 13,14 \$             |



Karanlığı Işıkla Buluşturur  
**SUNBOX** Ledli Solar  
Projektör

## SOLAR BAHÇE APLİK ÇEŞİTLERİ



CE

|            |                                    |
|------------|------------------------------------|
| Ürün Adı   | ZETA 4'LÜ LEDLİ SOLAR APLİK - IP65 |
| Ürün Kodu  | 016 038 200102                     |
| Renk       | 3000K                              |
| Lümen/Watt | 60Lm/10W                           |
| Kutu Adedi | 1/50                               |
| Fiyat (\$) | 20,00 \$                           |



CE

|            |                                    |
|------------|------------------------------------|
| Ürün Adı   | ZETA 6'LI LEDLİ SOLAR APLİK - IP65 |
| Ürün Kodu  | 016 038 200104                     |
| Renk       | 3000K                              |
| Lümen/Watt | 90Lm/15W                           |
| Kutu Adedi | 1/50                               |
| Fiyat (\$) | 28,33 \$                           |



CE

|            |   |
|------------|---|
| Ürün Adı   | VENUS LEDLİ SENSÖRLÜ SOLAR APLİK - IP65 |
| Ürün Kodu  | 016 038 200106                          |
| Renk       | 3000K                                   |
| Lümen/Watt | 60Lm/10W                                |
| Kutu Adedi | 1/80                                    |
| Fiyat (\$) | 18,33 \$                                |



CE

|            |  |
|------------|--|
| Ürün Adı   | MARS LEDLİ SOLAR BAHÇE ARMATÜRÜ - IP65 |
| Ürün Kodu  | 016 038 200108                         |
| Renk       | 3000K                                  |
| Lümen/Watt | 40Lm/7W                                |
| Kutu Adedi | 1/20                                   |
| Fiyat (\$) | 26,67 \$                               |



CE

|            |   |
|------------|---|
| Ürün Adı   | JUPİTER LEDLİ SOLAR BAHÇE ARMATÜRÜ - IP65 |
| Ürün Kodu  | 016 038 200110                            |
| Renk       | 3000-4500K KUMANDALI                      |
| Lümen/Watt | 380Lm/20W                                 |
| Kutu Adedi | 1/20                                      |
| Fiyat (\$) | 63,33 \$                                  |



CE

|            |                                  |
|------------|----------------------------------|
| Ürün Adı   | NEPTUNE LEDLİ SOLAR APLİK - IP65 |
| Ürün Kodu  | 016 038 200112                   |
| Renk       | 3000-4500K KUMANDALI             |
| Lümen/Watt | 380Lm/20W                        |
| Kutu Adedi | 1/20                             |
| Fiyat (\$) | 38,11 \$                         |



CE

|            |  |
|------------|--|
| Ürün Adı   | SATURN LEDLİ SOLAR BAHÇE ARMATÜRÜ - IP65 |
| Ürün Kodu  | 016 038 200114                           |
| Renk       | 3000-4500K KUMANDALI                     |
| Lümen/Watt | 960Lm/50W                                |
| Kutu Adedi | 1/6                                      |
| Fiyat (\$) | 89,91 \$                                 |

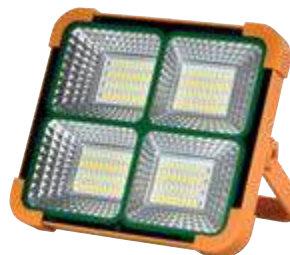

CE

|            |                                    |
|------------|------------------------------------|
| Ürün Adı   | SUNBOX LEDLİ SOLAR PROJKTÖR - IP65 |
| Ürün Kodu  | 016 038 200116                     |
| Renk       | W+R+B                              |
| Lümen/Watt | 1420Lm/200W                        |
| Kutu Adedi | 1/20                               |
| Fiyat (\$) | 40,00 \$                           |

# BAHÇE AYDINLATMA



|               |                              |
|---------------|------------------------------|
| Ürün Adı      | BURGAZ APLİK<br>28 CM - IP54 |
| Ürün Kodu     | 016 038 710002               |
| Duy           | E27                          |
| Kutu/Koli Ad. | 1/18                         |
| Fiyat (₺)     | <b>611,11</b>                |



|               |                             |
|---------------|-----------------------------|
| Ürün Adı      | SEDEF APLİK<br>28 CM - IP54 |
| Ürün Kodu     | 016 038 710006              |
| Duy           | E27                         |
| Kutu/Koli Ad. | 1/20                        |
| Fiyat (₺)     | <b>611,11</b>               |



|               |                                    |
|---------------|------------------------------------|
| Ürün Adı      | ALİZE KÜP SET ÜSTÜ<br>27 CM - IP54 |
| Ürün Kodu     | 016 038 710020                     |
| Duy           | E27                                |
| Kutu/Koli Ad. | 1/12                               |
| Fiyat (₺)     | <b>810,19</b>                      |



|               |                             |
|---------------|-----------------------------|
| Ürün Adı      | ERDEK APLİK<br>25 CM - IP54 |
| Ürün Kodu     | 016 038 710010              |
| Duy           | E27                         |
| Kutu/Koli Ad. | 1/18                        |
| Fiyat (₺)     | <b>611,11</b>               |



|               |                                      |
|---------------|--------------------------------------|
| Ürün Adı      | MARMARA KÜP SET ÜSTÜ<br>27 CM - IP54 |
| Ürün Kodu     | 016 038 710021                       |
| Duy           | E27                                  |
| Kutu/Koli Ad. | 1/12                                 |
| Fiyat (₺)     | <b>810,19</b>                        |



|               |                               |
|---------------|-------------------------------|
| Ürün Adı      | MARMARA APLİK<br>25 CM - IP54 |
| Ürün Kodu     | 016 038 710014                |
| Duy           | E27                           |
| Kutu/Koli Ad. | 1/20                          |
| Fiyat (₺)     | <b>638,89</b>                 |

## BAHÇE ARMATÜRLERİ

| Ürün Kodu      | Ürün Adı                        | Ölçü  | Kutu/Koli Ad. | Fiyat (₺) |
|----------------|---------------------------------|-------|---------------|-----------|
| 016 038 710005 | SEDEF SET ÜSTÜ - IP54 - E27 DUY | 42 CM | 1/16          | 611,11    |
| 016 038 710007 | SEDEF BOLLARD - IP54 - E27 DUY  | 60 CM | 1/12          | 839,12    |



| Ürün Kodu      | Ürün Adı                        | Ölçü  | Kutu/Koli Ad. | Fiyat (₺) |
|----------------|---------------------------------|-------|---------------|-----------|
| 016 038 710009 | ERDEK SET ÜSTÜ - IP54 - E27 DUY | 42 CM | 1/18          | 611,11    |
| 016 038 710011 | ERDEK BOLLARD - IP54 - E27 DUY  | 60 CM | 1/12          | 839,12    |
| 016 038 710012 | ERDEK BOLLARD - IP54 - E27 DUY  | 80 CM | 1/12          | 1.070,60  |



| Ürün Kodu      | Ürün Adı                         | Ölçü  | Kutu/Koli Ad. | Fiyat (₺) |
|----------------|----------------------------------|-------|---------------|-----------|
| 016 038 710001 | BURGAZ SET ÜSTÜ - IP54 - E27 DUY | 42 CM | 1/18          | 611,11    |
| 016 038 710003 | BURGAZ BOLLARD - IP54 - E27 DUY  | 60 CM | 1/12          | 839,12    |
| 016 038 710004 | BURGAZ BOLLARD - IP54 - E27 DUY  | 80 CM | 1/12          | 1.070,60  |



| Ürün Kodu      | Ürün Adı                          | Ölçü  | Kutu/Koli Ad. | Fiyat (₺) |
|----------------|-----------------------------------|-------|---------------|-----------|
| 016 038 710013 | MARMARA SET ÜSTÜ - IP54 - E27 DUY | 42 CM | 1/16          | 638,89    |
| 016 038 710015 | MARMARA BOLLARD - IP54 - E27 DUY  | 60 CM | 1/12          | 861,11    |
| 016 038 710016 | MARMARA BOLLARD - IP54 - E27 DUY  | 80 CM | 1/12          | 1.064,81  |



## BAHÇE ARMATÜRLERİ



| Ürün Kodu      | Ürün Adı                     | Kutu/Koli Ad. | Fiyat (₺) |
|----------------|------------------------------|---------------|-----------|
| 016 038 010116 | FLORA BAHÇE ARMATÜRÜ - SİYAH | 1/12          | 597,22    |
| 016 038 020116 | FLORA BAHÇE ARMATÜRÜ - BEYAZ | 1/12          | 597,22    |



| Ürün Kodu      | Ürün Adı                           | Kutu/Koli Ad. | Fiyat (₺) |
|----------------|------------------------------------|---------------|-----------|
| 016 038 010117 | FLORA BAHÇE ARMATÜRÜ APLİK - SİYAH | 1/12          | 597,22    |
| 016 038 020117 | FLORA BAHÇE ARMATÜRÜ APLİK - BEYAZ | 1/12          | 597,22    |



| Ürün Kodu      | Ürün Adı                                | Kutu/Koli Ad. | Fiyat (₺) |
|----------------|---|---------------|-----------|
| 016 038 412011 | FLORA BAHÇE ARMATÜRÜ TAVAN TİPİ - SİYAH | 1/12          | 665,28    |
| 016 038 412000 | FLORA BAHÇE ARMATÜRÜ TAVAN TİPİ - BEYAZ | 1/12          | 665,28    |



| Ürün Kodu      | Ürün Adı                                 | Kutu/Koli Ad. | Fiyat (₺) |
|----------------|--|---------------|-----------|
| 016 038 412111 | FLORA BAHÇE ARMATÜRÜ YARIM APLİK - SİYAH | 1/20          | 494,44    |
| 016 038 412100 | FLORA BAHÇE ARMATÜRÜ YARIM APLİK - BEYAZ | 1/20          | 494,44    |

## CE IP44

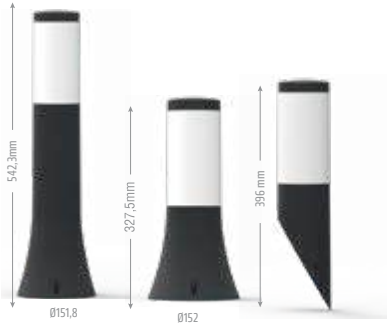

| Ürün Kodu      | Ürün Adı                           | Ölçü             | Kutu/Koli Ad. | Fiyat (₺) |
|----------------|------------------------------------|------------------|---------------|-----------|
| 016 038 010120 | GARDEN UZUN YER AYDINLATMA - SİYAH | 542,3mm x Ø151,8 | 1/8           | 624,54    |
| 016 038 010118 | GARDEN YER AYDINLATMA - SİYAH      | 327,5mm x Ø152   | 1/12          | 531,48    |
| 016 038 010122 | GARDEN DUVAR AYDINLATMA - SİYAH    | 396mm            | 1/20          | 510,65    |

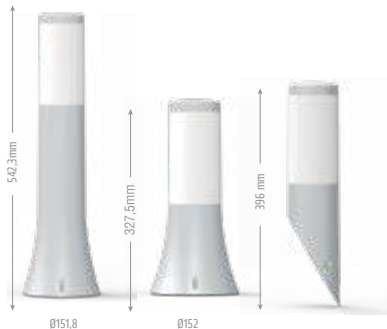

| Ürün Kodu      | Ürün Adı                         | Ölçü             | Kutu/Koli Ad. | Fiyat (₺) |
|----------------|----------------------------------|------------------|---------------|-----------|
| 016 038 010121 | GARDEN UZUN YER AYDINLATMA - GRİ | 542,3mm x Ø151,8 | 1/8           | 624,54    |
| 016 038 010119 | GARDEN YER AYDINLATMA - GRİ      | 327,5mm x Ø152   | 1/12          | 531,48    |
| 016 038 010123 | GARDEN DUVAR AYDINLATMA - GRİ    | 396mm            | 1/20          | 510,65    |

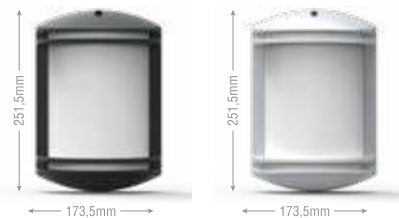

| Ürün Kodu      | Ürün Adı             | Kutu/Koli Ad. | Fiyat (₺) |
|----------------|----------------------|---------------|-----------|
| 016 038 010124 | GARDEN APLİK - SİYAH | 1/16          | 645,37    |
| 016 038 010125 | GARDEN APLİK - GRİ   | 1/16          | 645,37    |

| Ürün Kodu                          | Ölçü (mm) | Ürün Adı                    | Slot Aralığı (mm) | Ambalaj/Metre | Fiyat (₺) |
|------------------------------------|-----------|-----------------------------|-------------------|---------------|-----------|
| <b>PROMEX DELİKLİ KABLO KANALI</b> |           |                             |                   |               |           |
| 001 110 025030 20 17               | 25x30     | PROMEX DELİKLİ KABLO KANALI | 4/6/4 mm          | 2m 112        | 118,89    |
| 001 110 025040 20 17               | 25x40     | PROMEX DELİKLİ KABLO KANALI | 4/6/4 mm          | 2m 96         | 120,37    |
| 001 110 025060 20 17               | 25x60     | PROMEX DELİKLİ KABLO KANALI | 4/6/4 mm          | 2m 60         | 155,56    |
| 001 110 025080 20 17               | 25x80     | PROMEX DELİKLİ KABLO KANALI | 4/6/4 mm          | 2m 64         | 196,68    |
| 001 110 040040 20 17               | 40x40     | PROMEX DELİKLİ KABLO KANALI | 4/6/4 mm          | 2m 56         | 150,97    |
| 001 110 040060 20 17               | 40x60     | PROMEX DELİKLİ KABLO KANALI | 4/6/4 mm          | 2m 40         | 179,24    |
| 001 110 040080 20 17               | 40x80     | PROMEX DELİKLİ KABLO KANALI | 4/6/4 mm          | 2m 40         | 233,37    |
| 001 110 040100 20 17               | 40x100    | PROMEX DELİKLİ KABLO KANALI | 5/8/5 mm          | 2m 32         | 282,70    |
| 001 110 060040 20 17               | 60x40     | PROMEX DELİKLİ KABLO KANALI | 4/6/4 mm          | 2m 36         | 204,50    |
| 001 110 060060 20 17               | 60x60     | PROMEX DELİKLİ KABLO KANALI | 4/6/4 mm          | 2m 24         | 245,40    |
| 001 110 060080 20 17               | 60x80     | PROMEX DELİKLİ KABLO KANALI | 4/6/4 mm          | 2m 32         | 303,15    |
| 001 110 060100 20 17               | 60x100    | PROMEX DELİKLİ KABLO KANALI | 5/8/5 mm          | 2m 32         | 326,00    |
| 001 110 080060 20 17               | 80x60     | PROMEX DELİKLİ KABLO KANALI | 4/6/4 mm          | 2m 24         | 292,32    |
| 001 110 080080 20 17               | 80x80     | PROMEX DELİKLİ KABLO KANALI | 4/6/4 mm          | 2m 24         | 359,69    |
| 001 110 080100 20 17               | 80x100    | PROMEX DELİKLİ KABLO KANALI | 5/8/5 mm          | 2m 24         | 508,14    |
| 001 110 100060 20 17               | 100x60    | PROMEX DELİKLİ KABLO KANALI | 4/6/4 mm          | 2m 20         | 363,28    |
| 001 110 100080 20 17               | 100x80    | PROMEX DELİKLİ KABLO KANALI | 4/6/4 mm          | 2m 12         | 381,68    |
| 001 110 100100 20 17               | 100x100   | PROMEX DELİKLİ KABLO KANALI | 5/8/5 mm          | 2m 16         | 588,61    |
| 001 110 120060 20 17               | 120x60    | PROMEX DELİKLİ KABLO KANALI | 4/6/4 mm          | 2m 20         | 409,01    |
| 001 110 120080 20 17               | 120x80    | PROMEX DELİKLİ KABLO KANALI | 4/6/4 mm          | 2m 16         | 523,08    |

#### PROMEX KABLO KANALI KAPAKLARI

|                      |         |              |  |    |        |
|----------------------|---------|--------------|--|----|--------|
| 001 016 100025 20 17 | 25'LİK  | PROMEX KAPAK |  | 50 | 37,04  |
| 001 016 100040 20 17 | 40'LİK  | PROMEX KAPAK |  | 50 | 48,15  |
| 001 016 100060 20 17 | 60'LİK  | PROMEX KAPAK |  | 50 | 72,22  |
| 001 016 100080 20 17 | 80'LİK  | PROMEX KAPAK |  | 50 | 88,89  |
| 001 016 100100 20 17 | 100'LÜK | PROMEX KAPAK |  | 50 | 103,70 |
| 001 016 100120 20 17 | 120'LİK | PROMEX KAPAK |  | 50 | 127,78 |



**XX : 10** 1mt. delikli kablo kanalı için.  
**XX : 20** 2mt. delikli kablo kanalı için.

| Ürün Kodu | Ölçü (mm) | Ürün Adı | Ambalaj Koli - 1 m | Ambalaj Koli - 2 m | Fiyat (₺) |
|-----------|-----------|----------|--------------------|--------------------|-----------|
|-----------|-----------|----------|--------------------|--------------------|-----------|

### PANO İÇİN MEKS DELİKLİ KABLO KANALLAR (GRİ)

|                      |         |                                |       |        |        |
|----------------------|---------|--------------------------------|-------|--------|--------|
| 001 005 025025 XX 17 | 25x25   | MEKS DELİKLİ KABLO KANALI(GRİ) | 1m 64 | 2m 120 | 94,44  |
| 001 005 025040 XX 17 | 25x40   | MEKS DELİKLİ KABLO KANALI(GRİ) | 1m 40 | 2m 80  | 116,67 |
| 001 005 025060 XX 17 | 25x60   | MEKS DELİKLİ KABLO KANALI(GRİ) | 1m 36 | 2m 80  | 148,15 |
| 001 005 040040 XX 17 | 40x40   | MEKS DELİKLİ KABLO KANALI(GRİ) | 1m 25 | 2m 50  | 148,15 |
| 001 005 040060 XX 17 | 40x60   | MEKS DELİKLİ KABLO KANALI(GRİ) | 1m 24 | 2m 48  | 177,78 |
| 001 005 060040 XX 17 | 60x40   | MEKS DELİKLİ KABLO KANALI(GRİ) | 1m 24 | 2m 48  | 203,70 |
| 001 005 060060 XX 17 | 60x60   | MEKS DELİKLİ KABLO KANALI(GRİ) | 1m 16 | 2m 32  | 245,00 |
| 001 005 060080 XX 17 | 60x80   | MEKS DELİKLİ KABLO KANALI(GRİ) | 1m 12 | 2m 24  | 298,15 |
| 001 005 060100 XX 17 | 60x100  | MEKS DELİKLİ KABLO KANALI(GRİ) | 1m 8  | 2m 16  | 326,48 |
| 001 005 040080 XX 17 | 40x80   | MEKS DELİKLİ KABLO KANALI(GRİ) | 1m 18 | 2m 36  | 233,33 |
| 001 005 080060 XX 17 | 80x60   | MEKS DELİKLİ KABLO KANALI(GRİ) | 1m 12 | 2m 24  | 285,18 |
| 001 005 100060 XX 17 | 100x60  | MEKS DELİKLİ KABLO KANALI(GRİ) | 1m 8  | 2m 16  | 359,26 |
| 001 005 100100 XX 17 | 100x100 | MEKS DELİKLİ KABLO KANALI(GRİ) | 1m 4  | 2m 8   | 585,19 |

### PANO İÇİN MEKS DELİKLİ KABLO KANALLAR (MAVİ)

|                      |         |                                  |       |        |        |
|----------------------|---------|----------------------------------|-------|--------|--------|
| 001 005 025025 XX 13 | 25x25   | MEKS DELİKLİ KABLO KANALI(MAVİ)  | 1m 64 | 2m 120 | 96,21  |
| 001 005 025040 XX 13 | 25x40   | MEKS DELİKLİ KABLO KANALI(MAVİ)  | 1m 40 | 2m 80  | 125,00 |
| 001 005 025060 XX 13 | 25x60   | MEKS DELİKLİ KABLO KANALI(MAVİ)  | 1m 36 | 2m 80  | 168,52 |
| 001 005 040040 XX 13 | 40x40   | MEKS DELİKLİ KABLO KANALI(MAVİ)  | 1m 25 | 2m 50  | 159,26 |
| 001 005 040060 XX 13 | 40x60   | MEKS DELİKLİ KABLO KANALI(MAVİ)  | 1m 24 | 2m 48  | 192,59 |
| 001 005 060040 XX 13 | 60x40   | MEKS DELİKLİ KABLO KANALI(MAVİ)  | 1m 24 | 2m 48  | 216,11 |
| 001 005 060060 XX 13 | 60x60   | MEKS DELİKLİ KABLO KANALI(MAVİ)  | 1m 16 | 2m 32  | 265,37 |
| 001 005 060080 XX 13 | 60x80   | MEKS DELİKLİ KABLO KANALI (MAVİ) | 1m 12 | 2m 24  | 326,48 |
| 001 005 060100 XX 13 | 60x100  | MEKS DELİKLİ KABLO KANALI (MAVİ) | 1m 8  | 2m 16  | 360,07 |
| 001 005 040080 XX 13 | 40x80   | MEKS DELİKLİ KABLO KANALI(MAVİ)  | 1m 18 | 2m 36  | 279,13 |
| 001 005 080060 XX 13 | 80x60   | MEKS DELİKLİ KABLO KANALI(MAVİ)  | 1m 12 | 2m 24  | 333,82 |
| 001 005 100060 XX 13 | 100x60  | MEKS DELİKLİ KABLO KANALI(MAVİ)  | 1m 8  | 2m 16  | 441,81 |
| 001 005 100100 XX 13 | 100x100 | MEKS DELİKLİ KABLO KANALI(MAVİ)  | 1m 4  | 2m 8   | 674,07 |

### YAPIŞKAN BANTLI MEKS DELİKLİ KABLO KANALLAR (GRİ)

|                      |         |  |       |        |        |
|----------------------|---------|--|-------|--------|--------|
| 001 008 025025 XX 17 | 25x25   | MEKS DELİKLİ KABLO KANALI(YPŞK. BANTLI)(GRİ) | 1m 64 | 2m 120 | 101,52 |
| 001 008 025040 XX 17 | 25x40   | MEKS DELİKLİ KABLO KANALI(YPŞK. BANTLI)(GRİ) | 1m 40 | 2m 80  | 128,79 |
| 001 008 025060 XX 17 | 25x60   | MEKS DELİKLİ KABLO KANALI(YPŞK. BANTLI)(GRİ) | 1m 36 | 2m 80  | 171,24 |
| 001 008 040040 XX 17 | 40x40   | MEKS DELİKLİ KABLO KANALI(YPŞK. BANTLI)(GRİ) | 1m 25 | 2m 50  | 161,78 |
| 001 008 040060 XX 17 | 40x60   | MEKS DELİKLİ KABLO KANALI(YPŞK. BANTLI)(GRİ) | 1m 24 | 2m 48  | 196,85 |
| 001 008 060040 XX 17 | 60x40   | MEKS DELİKLİ KABLO KANALI(YPŞK. BANTLI)(GRİ) | 1m 24 | 2m 48  | 216,31 |
| 001 008 060060 XX 17 | 60x60   | MEKS DELİKLİ KABLO KANALI(YPŞK. BANTLI)(GRİ) | 1m 16 | 2m 32  | 270,37 |
| 001 008 060080 XX 17 | 60x80   | MEKS DELİKLİ KABLO KANALI(YPŞK. BANTLI)(GRİ) | 1m 12 | 2m 24  | 329,63 |
| 001 008 060100 XX 17 | 60x100  | MEKS DELİKLİ KABLO KANALI(YPŞK. BANTLI)(GRİ) | 1m 8  | 2m 16  | 364,89 |
| 001 008 040080 XX 17 | 40x80   | MEKS DELİKLİ KABLO KANALI(YPŞK. BANTLI)(GRİ) | 1m 18 | 2m 36  | 296,30 |
| 001 008 080060 XX 17 | 80x60   | MEKS DELİKLİ KABLO KANALI(YPŞK. BANTLI)(GRİ) | 1m 12 | 2m 24  | 339,06 |
| 001 008 100060 XX 17 | 100x60  | MEKS DELİKLİ KABLO KANALI(YPŞK. BANTLI)(GRİ) | 1m 8  | 2m 16  | 448,31 |
| 001 008 100100 XX 17 | 100x100 | MEKS DELİKLİ KABLO KANALI(YPŞK. BANTLI)(GRİ) | 1m 4  | 2m 8   | 668,73 |

### YAPIŞKAN BANTLI MEKS DELİKLİ KABLO KANALLAR (MAVİ)

|                      |         |   |       |        |        |
|----------------------|---------|---|-------|--------|--------|
| 001 008 025025 XX 13 | 25x25   | MEKS DELİKLİ KABLO KANALI(YPŞK. BANTLI)(MAVİ) | 1m 64 | 2m 120 | 106,36 |
| 001 008 025040 XX 13 | 25x40   | MEKS DELİKLİ KABLO KANALI(YPŞK. BANTLI)(MAVİ) | 1m 40 | 2m 80  | 136,43 |
| 001 008 025060 XX 13 | 25x60   | MEKS DELİKLİ KABLO KANALI(YPŞK. BANTLI)(MAVİ) | 1m 36 | 2m 80  | 188,38 |
| 001 008 040040 XX 13 | 40x40   | MEKS DELİKLİ KABLO KANALI(YPŞK. BANTLI)(MAVİ) | 1m 25 | 2m 50  | 172,73 |
| 001 008 040060 XX 13 | 40x60   | MEKS DELİKLİ KABLO KANALI(YPŞK. BANTLI)(MAVİ) | 1m 24 | 2m 48  | 222,22 |
| 001 008 060040 XX 13 | 60x40   | MEKS DELİKLİ KABLO KANALI(YPŞK. BANTLI)(MAVİ) | 1m 24 | 2m 48  | 230,44 |
| 001 008 060060 XX 13 | 60x60   | MEKS DELİKLİ KABLO KANALI(YPŞK. BANTLI)(MAVİ) | 1m 16 | 2m 32  | 292,59 |
| 001 008 060080 XX 13 | 60x80   | MEKS DELİKLİ KABLO KANALI(YPŞK. BANTLI)(MAVİ) | 1m 12 | 2m 24  | 362,96 |
| 001 008 060100 XX 13 | 60x100  | MEKS DELİKLİ KABLO KANALI(YPŞK. BANTLI)(MAVİ) | 1m 8  | 2m 16  | 396,30 |
| 001 008 040080 XX 13 | 40x80   | MEKS DELİKLİ KABLO KANALI(YPŞK. BANTLI)(MAVİ) | 1m 18 | 2m 36  | 343,99 |
| 001 008 080060 XX 13 | 80x60   | MEKS DELİKLİ KABLO KANALI(YPŞK. BANTLI)(MAVİ) | 1m 12 | 2m 24  | 405,68 |
| 001 008 100060 XX 13 | 100x60  | MEKS DELİKLİ KABLO KANALI(YPŞK. BANTLI)(MAVİ) | 1m 8  | 2m 16  | 519,40 |
| 001 008 100100 XX 13 | 100x100 | MEKS DELİKLİ KABLO KANALI(YPŞK. BANTLI)(MAVİ) | 1m 4  | 2m 8   | 746,08 |

| Ürün Kodu | Ölçü (mm) | Ürün Adı | Kutu Adedi | Fiyat (₺) |
|-----------|-----------|----------|------------|-----------|
|-----------|-----------|----------|------------|-----------|

### KABLO TUTUCU APARATI

|                      |       |                      |    |       |
|----------------------|-------|----------------------|----|-------|
| 001 050 010001 00 00 | 25x40 | KABLO TUTUCU APARATI | 50 | 57,41 |
| 001 050 010002 00 00 | 40x40 | KABLO TUTUCU APARATI | 50 | 57,41 |
| 001 050 010003 00 00 | 60x40 | KABLO TUTUCU APARATI | 50 | 57,41 |

### KABLO TUTUCU YAN APARATI

|                      |          |                          |     |       |
|----------------------|----------|--------------------------|-----|-------|
| 001 050 020001 00 00 | 40x40/60 | KABLO TUTUCU YAN APARATI | 100 | 21,30 |
| 001 050 020002 00 00 | 60x40/60 | KABLO TUTUCU YAN APARATI | 100 | 21,30 |
| 001 050 020004 00 00 | 100x60   | KABLO TUTUCU YAN APARATI | 100 | 33,33 |

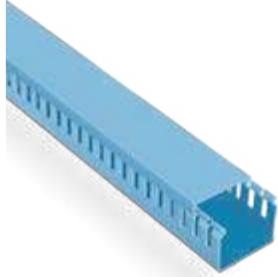

# MEKSPLUS<sup>+</sup>

## PANO



ZORLU ŞARTLAR İÇİN  
MAKSİMUM KORUMA

### MEKSPLUS OPAK KAPAKLI ABS PANOLAR

| Ürün Kodu      | Ölçü (cm)  | Ürün Adı                                | Ağırlık (kg) | Adet | Fiyat (₺) |
|----------------|------------|---|--------------|------|-----------|
| 048 096 203013 | 20X30X13   | MEKSPLUS PLASTİK OPAK KAPAKLI PANO IP67 | 1.64         | 1    | 1.566,04  |
| 048 096 253515 | 25X35X15   | MEKSPLUS PLASTİK OPAK KAPAKLI PANO IP67 | 2.29         | 1    | 2.056,71  |
| 048 096 304017 | 30X40X17   | MEKSPLUS PLASTİK OPAK KAPAKLI PANO IP67 | 3.13         | 1    | 2.547,38  |
| 048 096 405018 | 40X50X17,5 | MEKSPLUS PLASTİK OPAK KAPAKLI PANO IP67 | 4.90         | 1    | 3.735,20  |
| 048 096 405024 | 40X50X24   | MEKSPLUS PLASTİK OPAK KAPAKLI PANO IP67 | 5.52         | 1    | 4.287,20  |
| 048 096 406020 | 40X60X20   | MEKSPLUS PLASTİK OPAK KAPAKLI PANO IP67 | 6.30         | 1    | 4.321,96  |



### MEKSPLUS ŞEFFAF KAPAKLI ABS PANOLAR

| Ürün Kodu      | Ölçü (cm)  | Ürün Adı                                  | Ağırlık (kg) | Adet | Fiyat (₺) |
|----------------|------------|---|--------------|------|-----------|
| 048 097 203013 | 20X30X13   | MEKSPLUS PLASTİK ŞEFFAF KAPAKLI PANO IP67 | 1.68         | 1    | 1.772,80  |
| 048 097 253515 | 25X35X15   | MEKSPLUS PLASTİK ŞEFFAF KAPAKLI PANO IP67 | 2.29         | 1    | 2.284,80  |
| 048 097 304017 | 30X40X17   | MEKSPLUS PLASTİK ŞEFFAF KAPAKLI PANO IP67 | 3.13         | 1    | 2.779,73  |
| 048 097 405018 | 40X50X17,5 | MEKSPLUS PLASTİK ŞEFFAF KAPAKLI PANO IP67 | 5.06         | 1    | 4.428,80  |
| 048 097 405024 | 40X50X24   | MEKSPLUS PLASTİK ŞEFFAF KAPAKLI PANO IP67 | 5.57         | 1    | 5.041,07  |
| 048 097 406020 | 40X60X20   | MEKSPLUS PLASTİK ŞEFFAF KAPAKLI PANO IP67 | 6.37         | 1    | 5.179,73  |



# Promex<sup>PANO</sup>



## PROMEX OPAK KAPAKLI ABS PANOLAR - HALOGEN FREE

| Ürün Kodu            | Ölçü (cm) | Ürün Adı                         | Ağırlık (kg) | Adet | Fiyat (₺) |
|----------------------|-----------|----------------------------------|--------------|------|-----------|
| 001 046 203013 00 17 | 20x30x13  | PROMEX PLASTİK OPAK KAPAKLI PANO | 1,70         | 1    | 1.111,11  |
| 001 046 253515 00 17 | 25x35x15  | PROMEX PLASTİK OPAK KAPAKLI PANO | 2,20         | 1    | 1.574,07  |
| 001 046 304017 00 17 | 30x40x17  | PROMEX PLASTİK OPAK KAPAKLI PANO | 3,00         | 1    | 1.814,81  |
| 001 046 304022 00 17 | 30x40x22  | PROMEX PLASTİK OPAK KAPAKLI PANO | 3,40         | 1    | 2.222,22  |
| 001 046 355019 00 17 | 35x50x19  | PROMEX PLASTİK OPAK KAPAKLI PANO | 4,30         | 1    | 2.629,63  |
| 001 046 405018 00 17 | 40x50x18  | PROMEX PLASTİK OPAK KAPAKLI PANO | 4,30         | 1    | 2.777,78  |
| 001 046 405024 00 17 | 40x50x24  | PROMEX PLASTİK OPAK KAPAKLI PANO | 5,60         | 1    | 3.259,26  |
| 001 046 406020 00 17 | 40x60x20  | PROMEX PLASTİK OPAK KAPAKLI PANO | 6,00         | 1    | 3.407,41  |
| 001 046 507025 00 17 | 50x70x25  | PROMEX PLASTİK OPAK KAPAKLI PANO | 10,10        | 1    | 5.370,37  |
| 001 046 608026 00 17 | 60x80x26  | PROMEX PLASTİK OPAK KAPAKLI PANO | 13,50        | 1    | 8.703,70  |

## PROMEX ŞEFFAF KAPAKLI ABS PANOLAR - HALOGEN FREE

| Ürün Kodu            | Ölçü (cm) | Ürün Adı                           | Ağırlık (kg) | Adet | Fiyat (₺) |
|----------------------|-----------|------------------------------------|--------------|------|-----------|
| 001 046 203013 00 44 | 20x30x13  | PROMEX PLASTİK ŞEFFAF KAPAKLI PANO | 1,70         | 1    | 1.148,15  |
| 001 046 253515 00 44 | 25x35x15  | PROMEX PLASTİK ŞEFFAF KAPAKLI PANO | 2,20         | 1    | 1.666,67  |
| 001 046 304017 00 44 | 30x40x17  | PROMEX PLASTİK ŞEFFAF KAPAKLI PANO | 3,00         | 1    | 2.074,07  |
| 001 046 304022 00 44 | 30x40x22  | PROMEX PLASTİK ŞEFFAF KAPAKLI PANO | 3,40         | 1    | 2.508,48  |
| 001 046 355019 00 44 | 35x50x19  | PROMEX PLASTİK ŞEFFAF KAPAKLI PANO | 4,30         | 1    | 3.146,83  |
| 001 046 405018 00 44 | 40x50x18  | PROMEX PLASTİK ŞEFFAF KAPAKLI PANO | 4,30         | 1    | 3.323,81  |
| 001 046 405024 00 44 | 40x50x24  | PROMEX PLASTİK ŞEFFAF KAPAKLI PANO | 5,60         | 1    | 3.962,73  |
| 001 046 406020 00 44 | 40x60x20  | PROMEX PLASTİK ŞEFFAF KAPAKLI PANO | 6,00         | 1    | 3.963,32  |
| 001 046 507025 00 44 | 50x70x25  | PROMEX PLASTİK ŞEFFAF KAPAKLI PANO | 10,10        | 1    | 6.433,69  |
| 001 046 608026 00 44 | 60x80x26  | PROMEX PLASTİK ŞEFFAF KAPAKLI PANO | 13,50        | 1    | 10.050,79 |



IP65 CE

## PROMEX OPAK KAPAKLI ABS OTOMAT PANOLAR - HALOGEN FREE

| Ürün Kodu            | Ölçü (cm) | Ürün Adı                  | Ağırlık (kg) | Adet | Fiyat (₺) |
|----------------------|-----------|---------------------------|--------------|------|-----------|
| 001 046 253515 01 17 | 25x35x15  | PROMEX 18 OTOMATLI (9x2)  | 2,50         | 1    | 3.084,22  |
| 001 046 304017 01 17 | 30x40x17  | PROMEX 24 OTOMATLI (12x2) | 3,40         | 1    | 3.529,61  |
| 001 046 355019 01 17 | 35x50x19  | PROMEX 45 OTOMATLI (15x3) | 4,50         | 1    | 4.739,29  |
| 001 046 406020 01 17 | 40x60x20  | PROMEX 60 OTOMATLI (15x4) | 6,00         | 1    | 5.609,65  |



IP65 CE

## PROMEX ŞEFFAF KAPAKLI ABS OTOMAT PANOLAR - HALOGEN FREE

| Ürün Kodu            | Ölçü (cm) | Ürün Adı                  | Ağırlık (kg) | Adet | Fiyat (₺) |
|----------------------|-----------|---------------------------|--------------|------|-----------|
| 001 046 253515 01 44 | 25x35x15  | PROMEX 18 OTOMATLI (9x2)  | 2,50         | 1    | 3.114,49  |
| 001 046 304017 01 44 | 30x40x17  | PROMEX 24 OTOMATLI (12x2) | 3,40         | 1    | 3.553,70  |
| 001 046 355019 01 44 | 35x50x19  | PROMEX 45 OTOMATLI (15x3) | 4,50         | 1    | 4.789,93  |
| 001 046 406020 01 44 | 40x60x20  | PROMEX 60 OTOMATLI (15x4) | 6,00         | 1    | 5.964,64  |



## GALVANİZ TABAN SAÇLARI

| Ürün Kodu            | Ölçü (cm)  | Ürün Adı                | Adet | Fiyat (₺) |
|----------------------|------------|-------------------------|------|-----------|
| 000 702 203013 00 00 | 20x30x13   | GALVANİZ TABAN SAÇI 1mm | 1    | 227,61    |
| 000 702 253515 00 00 | 25x35x15   | GALVANİZ TABAN SAÇI 1mm | 1    | 253,35    |
| 000 702 304017 00 00 | 30x40x17   | GALVANİZ TABAN SAÇI 1mm | 1    | 330,04    |
| 000 702 304022 00 00 | 30x40x22   | GALVANİZ TABAN SAÇI 1mm | 1    | 338,81    |
| 000 702 355019 00 00 | 35x50x19   | GALVANİZ TABAN SAÇI 1mm | 1    | 478,80    |
| 000 702 405018 00 00 | 40x50x17,5 | GALVANİZ TABAN SAÇI 1mm | 1    | 571,90    |
| 000 702 405024 00 00 | 40x50x24   | GALVANİZ TABAN SAÇI 1mm | 1    | 559,33    |
| 000 702 406020 00 00 | 40x60x20   | GALVANİZ TABAN SAÇI 1mm | 1    | 680,90    |
| 000 702 507025 00 00 | 50x70x25   | GALVANİZ TABAN SAÇI 1mm | 1    | 971,54    |



## MODÜLER KİTLER ve SEPERATÖRLER

| Ürün Kodu            | Ölçü (cm) | Ürün Adı           | Adet | Fiyat (₺) |
|----------------------|-----------|--------------------|------|-----------|
| 000 700 253515 01 17 | 25X35X15  | 18 OTOMATLI (9X2)  | 1    | 1.860,91  |
| 000 700 304017 01 17 | 30X40X17  | 24 OTOMATLI (12X2) | 1    | 2.154,73  |
| 000 700 355019 01 17 | 35X50X19  | 45 OTOMATLI (15X3) | 1    | 2.938,27  |
| 000 700 406020 01 17 | 40X60X20  | 60 OTOMATLI (15X4) | 1    | 3.036,22  |
| 000 700 253515 00 17 | 25X35X15  | PLASTİK PERDE      | 1    | 259,26    |
| 000 700 304017 00 17 | 30X40X17  | PLASTİK PERDE      | 1    | 333,33    |
| 000 700 355019 00 17 | 35X50X19  | PLASTİK PERDE      | 1    | 555,56    |
| 000 700 406020 00 17 | 40X60X20  | PLASTİK PERDE      | 1    | 592,59    |



000 705 000720 00 00



000 700 000710 00 17



000 700 000711 00 17



000 700 000712 00 17



000 705 000721 00 00

## PANO AKSESUARLARI

| Ürün Kodu            | Ürün Adı                                   | Adet | Fiyat (₺) |
|----------------------|--|------|-----------|
| 000 705 000720 00 00 | PANO KİLİT GÖBEK TAKIMI (SET)              | 1    | 96,30     |
| 000 700 000710 00 17 | PANO DUVAR MONTAJ APARATI                  | 1    | 37,04     |
| 000 700 000711 00 17 | PANO ÜÇGEN ANAHTAR                         | 1    | 37,04     |
| 000 700 000712 00 17 | PANO SEPERATÖRÜ TUTTURMA VİDASI            | 1    | 55,56     |
| 000 705 000721 00 00 | PLASTİK KİLİTLENEBİLİR PANO (METAL) KİLİDİ | 1    | 1.018,52  |

YENİ

SAYAÇ  
PANOLARIŞantiyeler için güçlü,  
düzenli ve güvenli enerji çözümü...

Zorlu şantiye koşulları için özel olarak tasarlanan elektrik panolarımız, taban sacı ile güçlendirilmiş yapısı sayesinde maksimum dayanıklılık ve güvenli montaj imkânı sağlar...

Sayaç panosu; şalt ekipmanların daha sağlam, düzgün ve güvenli şekilde montajını sağlarken, saha uygulamalarında büyük kolaylık oluşturur.

Toza, darbeye ve dış etkenlere karşı dayanıklı gövdesiyle uzun ömürlü kullanım sunan panolarımız; hızlı kurulum, güvenli enerji dağıtımı ve şantiye ortamlarına tam uyum sağlar.



IP65 CE

## SAYAÇ PANOLARI - OPAK KAPAKLI

| Ürün Kodu      | Ölçü (cm) | Ürün Adı                               | Adet | Fiyat (₺) |
|----------------|-----------|--|------|-----------|
| 999 999 005302 | 30x50x19  | 1'Lİ TRİFAZE SAYAÇ PANOSU (10 Sigorta) | 1    | 3.632,79  |
| 999 999 005303 | 40x60x20  | 1'Lİ TRİFAZE SAYAÇ PANOSU (24 Sigorta) | 1    | 5.485,51  |

## Ray Tipi Pano Prizleri

Rayında Giden  
Güvenlik!



### RAY TİPİ PANO PRİZLERİ

|            |                                 |
|------------|---------------------------------|
| Ürün Kodu  | 010 104 000157                  |
| Ürün Adı   | MRP-16 1x16 RAY TİPİ PANO PRİZİ |
| Koli Adedi | 10                              |
| Fiyat (₺)  | <b>208,06</b>                   |



|            |  |
|------------|--|
| Ürün Kodu  | 010 104 000158                           |
| Ürün Adı   | MRP-LED 1x16 RAY TİPİ PANO PRİZİ - LEDLİ |
| Koli Adedi | 10                                       |
| Fiyat (₺)  | <b>307,13</b>                            |



|            |  |
|------------|--|
| Ürün Kodu  | 010 104 000159                         |
| Ürün Adı   | MRP-UPS 1X16 RAY TİPİ PANO PRİZİ - UPS |
| Koli Adedi | 10                                     |
| Fiyat (₺)  | <b>307,13</b>                          |

## PROMEX SERİSİ

### TERMOSTAT ve HİGROSTAT

## EKOFAN SERİSİ

### TERMOSTAT ve HİGROSTAT



#### ISITMA TERMOSTAT - NK

|               |                |
|---------------|----------------|
| Ürün Kodu     | 048 095 000300 |
| Ayar Sahası   | 0-60°C         |
| Kontakt Tipi  | NK             |
| Koruma Sınıfı | IP20           |
| Ağırlık       | 45 GR          |
| Koli Adet     | 135            |
| Fiyat (\$)    | <b>9,80 \$</b> |



#### SOĞUTUCU TERMOSTAT

|               |                |
|---------------|----------------|
| Ürün Kodu     | 048 095 101141 |
| Ayar Sahası   | 0-60°C         |
| Kontakt Tipi  | NO             |
| Koruma Sınıfı | IP20           |
| Ağırlık       | 45 GR          |
| Koli Adet     | 1              |
| Fiyat (\$)    | <b>6,79 \$</b> |



#### SOĞUTMA TERMOSTAT - NA

|               |                |
|---------------|----------------|
| Ürün Kodu     | 048 095 000301 |
| Ayar Sahası   | 0-60°C         |
| Kontakt Tipi  | NA             |
| Koruma Sınıfı | IP20           |
| Ağırlık       | 45 GR          |
| Koli Adet     | 135            |
| Fiyat (\$)    | <b>9,80 \$</b> |



#### MULTİ TERMOSTAT

|               |                 |
|---------------|-----------------|
| Ürün Kodu     | 048 095 101142  |
| Ayar Sahası   | 0-60°C / 0-60°C |
| Kontakt Tipi  | NC+NO           |
| Koruma Sınıfı | IP20            |
| Ağırlık       | 80 GR           |
| Koli Adet     | 1               |
| Fiyat (\$)    | <b>23,43 \$</b> |



#### DUAL TERMOSTAT - NK+NA

|               |                 |
|---------------|-----------------|
| Ürün Kodu     | 048 095 000302  |
| Ayar Sahası   | 0-60°C / 0-60°C |
| Kontakt Tipi  | NK+NA           |
| Koruma Sınıfı | IP20            |
| Ağırlık       | 80 GR           |
| Koli Adet     | 60              |
| Fiyat (\$)    | <b>19,59 \$</b> |



#### HİGROSTAT

|               |                 |
|---------------|-----------------|
| Ürün Kodu     | 048 095 101143  |
| Ayar Sahası   | %40-90RH        |
| Kontakt Tipi  | 1CO             |
| Koruma Sınıfı | IP20            |
| Ağırlık       | 180 GR          |
| Koli Adet     | 1               |
| Fiyat (\$)    | <b>70,28 \$</b> |



#### MEKANİK HİGROSTAT - 1CO

|               |                 |
|---------------|-----------------|
| Ürün Kodu     | 048 095 000303  |
| Ayar Sahası   | %10-90RH        |
| Kontakt Tipi  | 1CO             |
| Koruma Sınıfı | IP20            |
| Ağırlık       | 180 GR          |
| Koli Adet     | 30              |
| Fiyat (\$)    | <b>83,27 \$</b> |



#### ODA TERMOSTAT

|               |                 |
|---------------|-----------------|
| Ürün Kodu     | 048 095 101144  |
| Ayar Sahası   | %10-90RH        |
| Kontakt Tipi  | 1CO             |
| Koruma Sınıfı | IP20            |
| Ağırlık       | 180 GR          |
| Koli Adet     | 1               |
| Fiyat (\$)    | <b>74,96 \$</b> |



Teknik Veriler İçin  
Okutunuz

## PROMEX SERİSİ TEPE FANLARI



IP54



Poliüretan Conta



Radyal Fan

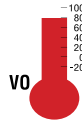

VO Alev İletmez ABS

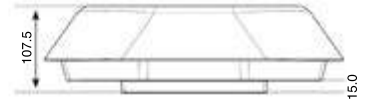
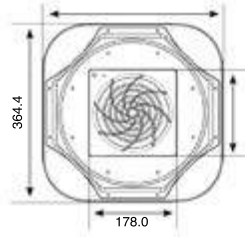

## PROMEX TEPE FANLARI

| Ürün Kodu      | Fan Tipi            | Besleme          | Güç (W) | Nominal Akım | Gürültü Seviyesi | Kapasite              | Adet | Fiyat (\$)       |
|----------------|---------------------|------------------|---------|--------------|------------------|-----------------------|------|------------------|
| 048 095 000100 | Ø172x163x51 AKSİYEL | 220V AC 50/60 Hz | 25/32W  | 0,11/0,15A   | 57 dB            | 400 m <sup>3</sup> /h | 1    | <b>81,48 \$</b>  |
| 048 095 000101 | Ø190x68 RADYAL      | 220V AC 50/60 Hz | 58/75W  | 0,26/0,34A   | 62 dB            | 560 m <sup>3</sup> /h | 1    | <b>162,96 \$</b> |
| 048 095 000102 | Ø220X71 RADYAL      | 220V AC 50/60 Hz | 85/90W  | 0,38/0,44A   | 73 dB            | 970 m <sup>3</sup> /h | 1    | <b>183,33 \$</b> |



Vidasız hızlı ve kolay montaj !



IP54



Poliüretan Conta



Radyal Fan

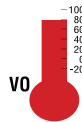

VO Alev İletmez ABS



Hızlı ve Kolay Montaj

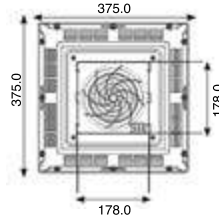

| Ürün Kodu      | Fan Tipi            | Besleme          | Güç (W) | Nominal Akım | Gürültü Seviyesi | Kapasite              | Adet | Fiyat (\$)       |
|----------------|---------------------|------------------|---------|--------------|------------------|-----------------------|------|------------------|
| 048 095 000200 | Ø172x163x51 AKSİYEL | 220V AC 50/60 Hz | 25/32W  | 0,11/0,15A   | 57 dB            | 400 m <sup>3</sup> /h | 1    | <b>81,48 \$</b>  |
| 048 095 000201 | Ø190x68 RADYAL      | 220V AC 50/60 Hz | 58/75W  | 0,26/0,34A   | 62 dB            | 560 m <sup>3</sup> /h | 1    | <b>162,96 \$</b> |
| 048 095 000202 | Ø220X71 RADYAL      | 220V AC 50/60 Hz | 85/90W  | 0,38/0,44A   | 73 dB            | 970 m <sup>3</sup> /h | 1    | <b>183,33 \$</b> |

## EKOFAN SERİSİ TEPE FANLARI



## EKOFAN TEPE FANLARI

| Ürün Kodu      | Fan Tipi | Besleme          | Güç (W) | Nominal Akım | Gürültü Seviyesi | Kapasite              | Adet | Fiyat (\$) |
|----------------|----------|------------------|---------|--------------|------------------|-----------------------|------|------------|
| 048 095 100100 | MTF300   | 230V AC 50/60 Hz | 35W     | 0,15A        | 51 dB            | 300 m <sup>3</sup> /h | 1    | 73,33 \$   |
| 048 095 100101 | MTF 600  | 230V AC 50/60 Hz | 65W     | 0,30A        | 60 dB            | 634 m <sup>3</sup> /h | 1    | 146,67 \$  |
| 048 095 100102 | MTF 900  | 230V AC 50/60 Hz | 90W     | 0,48A        | 60 dB            | 900 m <sup>3</sup> /h | 1    | 165,00 \$  |



## KOLAY MONTAJ FİLTRELER

| Ürün Kodu      | Ölçü (mm)    | Kesim Ölçüsü (mm) | Koruma Sınıfı | Adet / Koli | Fiyat (\$) |
|----------------|--------------|-------------------|---------------|-------------|------------|
| 048 095 000400 | 120x120x20,5 | 92x92             | IP54          | 200         | 4,69 \$    |
| 048 095 000401 | 160x160x31   | 125x125           | IP54          | 100         | 7,96 \$    |
| 048 095 000402 | 210x210x31   | 177x177           | IP54          | 100         | 11,71 \$   |
| 048 095 000403 | 260x260x31   | 223x223           | IP54          | 100         | 16,40 \$   |
| 048 095 000404 | 325x325x31   | 291x291           | IP54          | 100         | 32,80 \$   |



## PROJE CEPLERİ

| Ürün Kodu      | Ürün Adı      | Adet / Koli | Fiyat (\$) |
|----------------|---------------|-------------|------------|
| 048 095 000902 | PROJE CEBİ A4 | 1           | 5,14 \$    |
| 048 095 000903 | PROJE CEBİ A5 | 1           | 4,03 \$    |

## FİLTRELİ FANLAR



048 095 000500



048 095 000501



048 095 000502

|                               |                |                |                |
|-------------------------------|----------------|----------------|----------------|
| Ürün Kodu                     | 048 095 000500 | 048 095 000501 | 048 095 000502 |
| Ölçü (mm)                     | 120x120x58,5   | 160x160x69     | 120x120x58,5   |
| Kesim Ölçüsü (mm)             | 92x92          | 125x125        | 92x92          |
| Fan Tipi                      | 80x80x38       | 120x120x38     | 80x80x38       |
| Besleme (VAC)                 | 230V-50/60Hz   | 230V-50/60Hz   | 230V-50/60Hz   |
| Güç (W)                       | 14 (13)        | 26 (23)        | 14 (13)        |
| Hız (Rpm)                     | 2800           | 2700           | 2800           |
| Filtreli (m <sup>3</sup> /H)  | 30             | 100            | 30             |
| Filtresiz (m <sup>3</sup> /H) | 41             | 140            | 41             |
| Nominal Akım                  | 0,08 / 0,07    | 0,14 / 0,13    | 0,8 / 0,7      |
| Gürültü Seviyesi (Db)         | 28 (31)        | 42 (46)        | 28 (31)        |
| Adet / Fiyat (\$)             | 28,11 \$       | 37,48 \$       | 42,17 \$       |



048 095 000600



048 095 000601



048 095 000602



048 095 000603

|                               |                |                |                |                |
|-------------------------------|----------------|----------------|----------------|----------------|
| Ürün Kodu                     | 048 095 000600 | 048 095 000601 | 048 095 000602 | 048 095 000603 |
| Ölçü (mm)                     | 160x160x69     | 210x210x98     | 210x210x83     | 260x260x103    |
| Kesim Ölçüsü (mm)             | 125x125        | 177x177        | 177x177        | 223x223        |
| Fan Tipi                      | 120x120x38     | 120x120x38     | 173x163x51     | 120x120x38     |
| Besleme (VAC)                 | 230V-50/60Hz   | 230V-50/60Hz   | 230V-50/60Hz   | 230V-50/60Hz   |
| Güç (W)                       | 26 (23)        | 26 (23)        | 37 (35)        | 26 (23)        |
| Hız (Rpm)                     | 2700           | 2700           | 2400           | 2700           |
| Filtreli (m <sup>3</sup> /h)  | 100            | 125            | 175            | 115            |
| Filtresiz (m <sup>3</sup> /h) | 140            | 175            | 245            | 130            |
| Nominal Akım                  | 0,14 / 0,13    | 0,14 / 0,13    | 0,23 / 0,22    | 0,14 / 0,13    |
| Gürültü Seviyesi (Db)         | 42 (46)        | 42 (46)        | 52 (53)        | 42 (46)        |
| Adet / Fiyat (\$)             | 46,85 \$       | 65,59 \$       | 83,33 \$       | 84,33 \$       |



048 095 000604



048 095 000605



048 095 000606



048 095 000607

|                               |                |                |                |                |
|-------------------------------|----------------|----------------|----------------|----------------|
| Ürün Kodu                     | 048 095 000604 | 048 095 000605 | 048 095 000606 | 048 095 000607 |
| Ölçü (mm)                     | 260x260x116    | 260x260x111    | 325x325x145    | 325x325x111    |
| Kesim Ölçüsü (mm)             | 223x223        | 223x223        | 291x291        | 291x291        |
| Fan Tipi                      | 172x163x51     | 225x225x80     | 225x225x80     | 280x280x80     |
| Besleme (VAC)                 | 230V-50/60Hz   | 230V-50/60Hz   | 230V-50/60Hz   | 230V-50/60Hz   |
| Güç (W)                       | 37 (35)        | 66 (75)        | 66 (75)        | 110 (140)      |
| Hız (Rpm)                     | 2400           | 2600           | 2600           | 2600           |
| Filtreli (m <sup>3</sup> /h)  | 240            | 650            | 700            | 850            |
| Filtresiz (m <sup>3</sup> /h) | 270            | 900            | 950            | 1200           |
| Nominal Akım                  | 0,23 / 0,22    | 0,35 / 0,38    | 0,35 / 0,38    | 0,50 / 0,72    |
| Gürültü Seviyesi (Db)         | 52 (53)        | 60 (63)        | 60 (63)        | 65 (68)        |
| Adet / Fiyat (\$)             | 93,70 \$       | 234,26 \$      | 257,69 \$      | 281,11 \$      |



MINİ ISITICI



PTC ISITICI



SLİM ISITICI

## PANO ISITICILARI

| Ürün Kodu      | Ürün Adı                     | Besleme        | Koruma Sınıfı | Ölçüler (AxBxC)mm | Bağlantı | Adet | Fiyat (\$) |
|----------------|------------------------------|----------------|---------------|-------------------|----------|------|------------|
| 048 095 000700 | 15W PTC PANO ISITICISI       | 100-250V AC-DC | IP20          | 60x50x27          | KABLO    | 1    | 32,80 \$   |
| 048 095 000701 | 25W PTC PANO ISITICISI       | 100-250V AC-DC | IP20          | 70x50x27          | KABLO    | 1    | 37,48 \$   |
| 048 095 000702 | 30W PTC PANO ISITICISI       | 100-250V AC-DC | IP20          | 128x70x59         | KLEMENS  | 1    | 56,22 \$   |
| 048 095 000703 | 50W PTC PANO ISITICISI       | 100-250V AC-DC | IP20          | 138x70x59         | KLEMENS  | 1    | 65,59 \$   |
| 048 095 000704 | 75W PTC PANO ISITICISI       | 100-250V AC-DC | IP20          | 178x70x59         | KLEMENS  | 1    | 79,65 \$   |
| 048 095 000705 | 100W PTC PANO ISITICISI      | 100-250V AC-DC | IP20          | 188x70x59         | KLEMENS  | 1    | 93,70 \$   |
| 048 095 000706 | 150W PTC PANO ISITICISI      | 100-250V AC-DC | IP20          | 228x70x59         | KLEMENS  | 1    | 112,44 \$  |
| 048 095 000707 | 30W SLİM PTC PANO ISITICISI  | 100-250V AC-DC | IP20          | 128x27x80         | KLEMENS  | 1    | 56,22 \$   |
| 048 095 000708 | 50W SLİM PTC PANO ISITICISI  | 100-250V AC-DC | IP20          | 138x27x80         | KLEMENS  | 1    | 65,59 \$   |
| 048 095 000709 | 75W SLİM PTC PANO ISITICISI  | 100-250V AC-DC | IP20          | 178x27x80         | KLEMENS  | 1    | 79,65 \$   |
| 048 095 000710 | 100W SLİM PTC PANO ISITICISI | 100-250V AC-DC | IP20          | 188x27x80         | KLEMENS  | 1    | 93,70 \$   |
| 048 095 000711 | 150W SLİM PTC PANO ISITICISI | 100-250V AC-DC | IP20          | 228x27x80         | KLEMENS  | 1    | 112,44 \$  |



FANLI PTC ISITICI



FANLI ISITICI



400W PLASTİK FANLI ISITICI

## FANLI PANO ISITICILARI

| Ürün Kodu      | Ürün Adı                              | Besleme          | Koruma Sınıfı | Ölçüler (AxBxC)mm | Bağlantı | Adet | Fiyat (\$) |
|----------------|---------------------------------------|------------------|---------------|-------------------|----------|------|------------|
| 048 095 000800 | 100W FANLI PTC PANO ISITICISI         | 230V AC 50/60 Hz | IP20          | 170x89x60         | KLEMENS  | 1    | 187,41 \$  |
| 048 095 000801 | 150W FANLI PTC PANO ISITICISI         | 230V AC 50/60 Hz | IP20          | 210x89x60         | KLEMENS  | 1    | 210,83 \$  |
| 048 095 000802 | 250W FANLI REZİSTANS PANO ISITICISI   | 230V AC 50/60 Hz | IP20          | 152x110x80        | KLEMENS  | 1    | 234,26 \$  |
| 048 095 000803 | 500W FANLI REZİSTANS PANO ISITICISI   | 230V AC 50/60 Hz | IP20          | 182x110x80        | KLEMENS  | 1    | 243,63 \$  |
| 048 095 000804 | 750W FANLI REZİSTANS PANO ISITICISI   | 230V AC 50/60 Hz | IP20          | 232x110x80        | KLEMENS  | 1    | 281,11 \$  |
| 048 095 000805 | 200/300/400W FANLI PTC PANO ISITICISI | 230V AC 50/60 Hz | IP20          | 99x70x67          | KABLO    | 1    | 257,69 \$  |

## PROMEX SERİSİ PUSH-IN TİP RAY KLEMENSLER

|   | Ürün Kodu      | Ürün Adı  | Gerilim / Akım V/A | Kutu Adedi | Fiyat (\$) |
|---|----------------|---|--------------------|------------|------------|
|    | 065 095 0XX015 | <b>MP1.5</b><br>1,5 mm<br>Ray Klemens Push-In Tip                                 | 800V<br>15A        | 100        | 0,88 \$    |
|    | 065 095 0XX025 | <b>MP2.5</b><br>2,5 mm<br>Ray Klemens Push-In Tip                                 | 1000V<br>24A       | 100        | 0,91 \$    |
|    | 065 095 0XX004 | <b>MP4</b><br>4 mm<br>Ray Klemens Push-In Tip                                     | 1000V<br>32A       | 100        | 1,21 \$    |
|    | 065 095 0XX010 | <b>MP6/10</b><br>6/10 mm<br>Ray Klemens Push-In Tip                               | 1000V<br>57A       | 100        | 2,56 \$    |
|    | 065 095 417015 | <b>MP1.5/3</b><br>1,5 mm<br>1 Giriş 2 Çıkış<br>Ray Klemens Push-In Tip            | 800V<br>15A        | 100        | 1,42 \$    |
|   | 065 095 217015 | <b>MP1.5/4</b><br>1,5 mm<br>1 Giriş 3 Çıkış<br>Ray Klemens Push-In Tip            | 800V<br>15A        | 100        | 1,65 \$    |
|  | 065 095 4XX025 | <b>MP2.5/3</b><br>2,5 mm<br>1 Giriş 2 Çıkış<br>Ray Klemens Push-In Tip            | 1000V<br>24A       | 100        | 1,79 \$    |
|  | 065 095 2XX025 | <b>MP2.5/4</b><br>2,5 mm<br>1 Giriş 3 Çıkış<br>Ray Klemens Push-In Tip            | 1000V<br>24A       | 100        | 2,20 \$    |
|  | 065 095 1XX025 | <b>MPDL2.5</b><br>2,5 mm<br>Çift Katlı 2 Giriş 2 Çıkış<br>Ray Klemens Push-In Tip | 1000V<br>24A       | 50         | 2,23 \$    |
|  | 065 095 1XX004 | <b>MPDL4</b><br>4 mm<br>Çift Katlı 2 Giriş 2 Çıkış<br>Ray Klemens Push-In Tip     | 1000V<br>32A       | 50         | 4,82 \$    |
|  | 065 095 4XX004 | <b>MP4/3</b><br>4 mm<br>1 Giriş 2 Çıkış<br>Ray Klemens Push-In Tip                | 1000V<br>32A       | 50         | 2,28 \$    |
|  | 065 095 2XX004 | <b>MP4/4</b><br>4 mm<br>1 Giriş 3 Çıkış<br>Ray Klemens Push-In Tip                | 1000V<br>32A       | 50         | 2,75 \$    |
|  | 065 095 4XX010 | <b>MP6/10/3</b><br>6/10 mm<br>1 Giriş 2 Çıkış<br>Ray Klemens Push-In Tip          | 1000V<br>57A       | 50         | 4,95 \$    |

### XX KARŞILIĞI OLAN RENK KODLARI



00  
BEYAZ



11  
SİYAH



12  
TURUNCU



13  
MAVİ



15  
YEŞİL



16  
KIRMIZI





17  
GRİ







21  
KAHVERENGİ



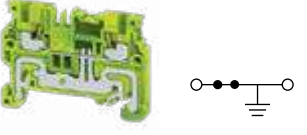

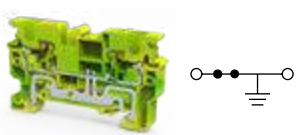





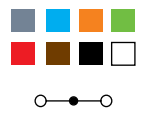

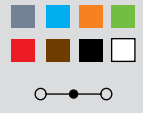

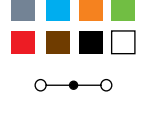

## PROMEX SERİSİ PUSH-IN TİP RAY KLEMENSLER

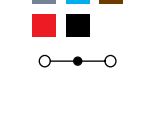
|   | Ürün Kodu      | Ürün Adı  | Gerilim / Akım<br>V/A | Kutu<br>Adedi | Fiyat<br>(\$) |
|---|----------------|---|-----------------------|---------------|---------------|
|    | 065 095 317025 | <b>MPTL2.5</b><br>2,5 mm<br>Üç Katlı 2 Giriş 2 Çıkış<br>Ray Klemens Push-In Tip   | 500V<br>24A           | 50            | 5,50 \$       |
|    | 065 095 617025 | <b>MP4L16</b><br>1,5 mm<br>Dört Katlı 2 Giriş 2 Çıkış<br>Ray Klemens Push-In Tip  | 320V<br>8A            | 10            | 38,33 \$      |
|    | 065 095 817025 | <b>MP8L32</b><br>1,5 mm<br>Sekiz Katlı 2 Giriş 2 Çıkış<br>Ray Klemens Push-In Tip | 320V<br>8A            | 10            | 51,00 \$      |
|    | 065 095 017030 | <b>MPK2.5</b><br>2,5 mm<br>Ayrırma Test Klemensi Push-In Tip                      | 1000V<br>20A          | 100           | 4,76 \$       |
|    | 065 095 017032 | <b>MPK4</b><br>4 mm<br>Ayrırma Test Klemensi Push-In Tip                          | 1000V<br>20A          | 50            | 5,69 \$       |
|   | 065 095 117030 | <b>MPDLK2.5</b><br>2,5 mm<br>Çift Katlı Ayrırma Klemensi Push-In Tip              | 500V<br>16A           | 50            | 15,76 \$      |
|  | 065 095 017034 | <b>MPST1.5/3</b><br>1,5 mm<br>Sensör ve Aktüatör Klemensi Push-In Tip             | 250V<br>13.5A         | 50            | 9,67 \$       |
|  | 065 095 017036 | <b>MPST1.5/4</b><br>1,5 mm<br>Sensör ve Aktüatör Klemensi Push-In Tip             | 250V<br>13.5A         | 50            | 12,00 \$      |

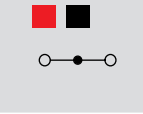
## PROMEX SERİSİ TOPRAKLAMALI PUSH-IN TİP RAY KLEMENSLER

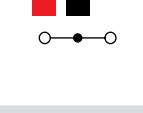
|   | Ürün Kodu      | Ürün Adı   | Kutu<br>Adedi | Fiyat<br>(\$) |
|---|----------------|--|---------------|---------------|
|  | 065 095 345015 | <b>MPG1.5</b><br>1,5 mm<br>Ray Klemens<br>Topraklama Push-In Tip<br>Sarı-Yeşil   | 100           | 3,03 \$       |
|  | 065 095 345025 | <b>MPG2.5</b><br>2,5 mm<br>Ray Klemens<br>Topraklama Push-In Tip<br>Sarı-Yeşil   | 100           | 3,18 \$       |
|  | 065 095 345004 | <b>MPG4</b><br>4 mm<br>Ray Klemens<br>Topraklama Push-In Tip<br>Sarı-Yeşil       | 100           | 4,04 \$       |
|  | 065 095 345010 | <b>MPG6/10</b><br>6/10 mm<br>Ray Klemens<br>Topraklama Push-In Tip<br>Sarı-Yeşil | 100           | 5,65 \$       |

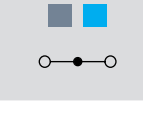
## PROMEX SERİSİ VİDALI TİP RAY KLEMENSLER

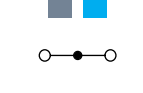
|   | Ürün Kodu      | Ürün Adı   | Gerilim / Akım<br>V/A | Kutu<br>Adedi | Fiyat<br>(\$) |
|---|----------------|--|-----------------------|---------------|---------------|
|       | 065 094 0XX025 | <b>MTS2.5UN</b><br>2,5 mm Ray Klemens<br>Vidalı Tip      | 1000V<br>24A          | 100           | 0,66 \$       |
|       | 065 094 0XX004 | <b>MTS4UN</b><br>4 mm Ray Klemens<br>Vidalı Tip          | 1000V<br>32A          | 100           | 0,81 \$       |
|       | 065 094 0XX006 | <b>MTS6U</b><br>6 mm Ray Klemens<br>Vidalı Tip           | 1000V<br>41A          | 100           | 1,19 \$       |
|       | 065 094 0XX010 | <b>MTS10U</b><br>10 mm Ray Klemens<br>Vidalı Tip         | 1000V<br>57A          | 100           | 1,49 \$       |
|   | 065 094 0XX016 | <b>MTS16U</b><br>16 mm Ray Klemens<br>Vidalı Tip         | 1000V<br>76A          | 50            | 2,29 \$       |
|   | 065 094 0XX026 | <b>MTS25U</b><br>25 mm Ray Klemens<br>Vidalı Tip         | 1000V<br>101A         | 50            | 3,89 \$       |
|   | 065 094 0XX035 | <b>MTS35U</b><br>35 mm Ray Klemens<br>Vidalı Tip         | 1000V<br>125A         | 50            | 4,76 \$       |
|   | 065 094 0XX070 | <b>MTS50/70N</b><br>50/70 mm Ray Klemens<br>Vidalı Tip   | 1000V<br>192A         | 20            | 17,24 \$      |
|   | 065 094 0XX120 | <b>MTS95/120N</b><br>95/120 mm Ray Klemens<br>Vidalı Tip | 1000V<br>269A         | 10            | 25,66 \$      |

### XX KARŞILIĞI OLAN RENK KODLARI



00  
BEYAZ



11  
SIYAH



12  
TURUNCU



13  
MAVİ



15  
YEŞİL



16  
KIRMIZI







17  
GRİ

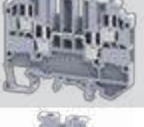

21  
KAHVERENGİ

## PROMEX SERİSİ VIDALI TİP RAY KLEMENSLER

|  | Ürün Kodu      | Ürün Adı   | Gerilim / Akım<br>V/A | Kutu<br>Adedi | Fiyat<br>(\$) |
|--|----------------|--|-----------------------|---------------|---------------|
|   | 065 094 017150 | <b>MPTB120/150</b><br>120/150 mm Ray Klemens<br>Vidalı tip                       | 1000V<br>310A         | 5             | 33,00 \$      |
|   | 065 094 017240 | <b>MPTB185/240</b><br>185/240 mm Ray Klemens<br>Vidalı tip                       | 1000V<br>420A         | 2             | 55,00 \$      |
|   | 065 094 417025 | <b>MMC1-2</b><br>2,5 mm<br>1 Giriş 2 Çıkış Ray Klemens<br>Vidalı Tip             | 630V<br>32A           | 100           | 1,20 \$       |
|   | 065 094 217025 | <b>MMC2-2</b><br>2,5 mm<br>2 Giriş 2 Çıkış Ray Klemens<br>Vidalı Tip             | 630V<br>32A           | 50            | 1,46 \$       |
|   | 065 094 117025 | <b>MDL2,5A</b><br>2,5 mm<br>Çift Katlı 2 Giriş 2 Çıkış Ray Klemens<br>Vidalı Tip | 800V<br>24A           | 50            | 3,14 \$       |
|  | 065 094 117004 | <b>MDL4UN</b><br>4 mm<br>Çift Katlı 2 Giriş 2 Çıkış Ray Klemens<br>Vidalı Tip    | 800V<br>32A           | 100           | 2,33 \$       |

## PROMEX SERİSİ TOPRAKLAMALI VİDALI TİP RAY KLEMENSLER

|   | Ürün Kodu      | Ürün Adı  | Kutu<br>Adedi | Fiyat<br>(\$) |
|---|----------------|---|---------------|---------------|
|  | 065 094 345025 | <b>MTSG2.5</b><br>2,5 mm<br>Ray Klemens<br>Topraklama Vidalı Tip Sarı-Yeşil     | 50            | 2,94 \$       |
|  | 065 094 345004 | <b>MTSG4</b><br>4 mm<br>Ray Klemens<br>Topraklama Vidalı Tip Sarı-Yeşil         | 50            | 3,30 \$       |
|  | 065 094 345006 | <b>MGT6N</b><br>6 mm<br>Ray Klemens<br>Topraklama Vidalı Tip Sarı-Yeşil         | 50            | 3,66 \$       |
|  | 065 094 345010 | <b>MGT10N</b><br>10 mm<br>Ray Klemens<br>Topraklama Vidalı Tip Sarı-Yeşil       | 50            | 4,59 \$       |
|  | 065 094 345016 | <b>MGT16N</b><br>16 mm<br>Ray Klemens<br>Topraklama Vidalı Tip Sarı-Yeşil       | 50            | 6,60 \$       |
|  | 065 094 345035 | <b>MGT35U</b><br>35 mm<br>Ray Klemens<br>Topraklama Vidalı Tip Sarı-Yeşil       | 20            | 12,10 \$      |
|  | 065 094 345070 | <b>MGT50/70N</b><br>50/70 mm<br>Ray Klemens<br>Topraklama Vidalı Tip Sarı-Yeşil | 20            | 33,00 \$      |

## PROMEX SERİSİ RAY KLEMENSLER İÇİN AKSESUARLAR

|   | Ürün Kodu      | Ürün Adı  | Kutu Adedi | Fiyat (\$) |
|---|----------------|---|------------|------------|
|    | 065 095 017038 | <b>MPA</b><br>Bıçaklı Sigorta Klemensi<br>Push-in Tip 1000V / 30A                           | 50         | 26,95 \$   |
|    | 065 096 000062 | <b>MF4U</b><br>Sigortalı Klemens<br>800V / 6,3A   | 100        | 3,49 \$    |
|    | 065 096 000064 | <b>MF4UL6</b><br>Sigortalı Klemens<br>Ledli 6 - 60 V AC/DC                                  | 100        | 4,21 \$    |
|    | 065 096 000066 | <b>MF4UL11</b><br>Sigortalı Klemens<br>Ledli 220V 110-240V AC/DC                            | 100        | 6,60 \$    |
|    | 065 096 000061 | <b>MSGU/TS</b><br>Test Klemensi<br>Vidalı Tip   | 50         | 10,50 \$   |
|    | 065 096 000068 | <b>MA802</b><br>Durdurucu Kapak - Vidalı  | 50         | 0,80 \$    |
|    | 065 096 000069 | <b>MA103</b><br>Durdurucu Kapak - Vidasız   | 50         | 0,83 \$    |
|   | 065 096 000070 | <b>MGMH6</b><br>Grup Etiketi  | 25         | 0,69 \$    |
|  | 065 096 000050 | <b>MPPCX4</b><br>4 mm Bölüm Plakası   | 50         | 0,60 \$    |
|  | 065 096 000142 | <b>TX2.5</b><br>2,5 mm Push-in Modülü   | 20         | 8,62 \$    |
|  | 065 096 000080 | <b>MA741/10</b><br>MTS2,5 için<br>Üst Köprü Vidalı Tip 10'lu - 24A                          | 10         | 5,00 \$    |
|  | 065 096 000082 | <b>MA742/10</b><br>MTS4UN / MCMC1 / MCMC2 için<br>Üst Köprü Vidalı Tip 10'lu - 32A          | 10         | 5,00 \$    |
|  | 065 096 000084 | <b>MA743/10</b><br>MTS6U için<br>Üst Köprü Vidalı Tip 10'lu - 41A                           | 10         | 5,00 \$    |
|  | 065 096 000086 | <b>MA744/10</b><br>MTS10U için<br>Üst Köprü Vidalı Tip 10'lu - 57A                          | 10         | 6,67 \$    |
|  | 065 096 000088 | <b>MA747/10</b><br>MDL4UN için Üst Köprü Çift Katlı<br>Vidalı Tip 10'lu - 32A               | 10         | 5,00 \$    |
|  | 065 096 000090 | <b>MA722/10</b><br>MTS4UN / MMC1 / MMC2 için<br>İzolesiz - Üst Köprü Vidalı Tip 10'lu - 32A | 10         | 5,00 \$    |
|  | 065 096 000092 | <b>MJX1.5/10</b><br>1,5 mm için<br>Üst Köprü Push-in Tip 10'lu                              | 10         | 5,80 \$    |
|  | 065 096 000020 | <b>MJX2.5/10</b><br>2,5 mm için<br>Üst Köprü Push-in Tip 10'lu - 24A                        | 10         | 3,33 \$    |
|  | 065 096 000022 | <b>MJX4/10</b><br>4 mm için<br>Üst Köprü Push-in Tip 10'lu - 32A                            | 10         | 3,83 \$    |
|  | 065 096 000044 | <b>MJX6/10</b><br>6/10 mm için<br>Köprü Push-in Tip 10'lu - 41A                             | 10         | 5,00 \$    |

## RAY KLEMENS SONLAMA KAPAKLARI

| Ürün Kodu      | Ürün Adı  | Kutu Adedi | Fiyat (\$) |
|----------------|---|------------|------------|
| 065 096 000114 | <b>MEPX2.5/4</b><br>MTS2,5 ve MTS4 için Yan Kapak Vidalı Tip            | 50         | 0,50 \$    |
| 065 096 000074 | <b>MEP6/10</b><br>MTS6 ve MTS10 için Yan Kapak Vidalı Tip               | 50         | 0,63 \$    |
| 065 096 000116 | <b>MEPC1.5</b><br>MP1,5 ve MPG1,5 için Yan Kapak Push-in Tip            | 50         | 0,60 \$    |
| 065 096 000052 | <b>MEPCX2.5</b><br>MP2,5 ve MPG2,5 için Yan Kapak Push-in Tip           | 50         | 0,50 \$    |
| 065 096 000054 | <b>MEPCX4</b><br>MP4 ve MPG4 için Yan Kapak Push-in Tip                 | 50         | 0,50 \$    |
| 065 096 000056 | <b>MEPCX6</b><br>MP6/10 ve MPG6/10 için Yan Kapak Push-in Tip           | 50         | 0,50 \$    |
| 065 096 000118 | <b>MEPCP1.5/3</b><br>MP1,5/3 için Çoklu Yan Kapak Push-in Tip           | 50         | 0,60 \$    |
| 065 096 000120 | <b>MEPCX1.5/4</b><br>MP1,5/4 için Çoklu Yan Kapak Push-in Tip           | 50         | 0,73 \$    |
| 065 096 000122 | <b>MEPCX2.5/3</b><br>MP2,5/3 ve MPK2,5 için Çoklu Yan Kapak Push-in Tip | 50         | 0,67 \$    |
| 065 096 000072 | <b>MEP2.5/4</b><br>MP2,5/4 için Çoklu Yan Kapak Push-in Tip             | 50         | 0,63 \$    |
| 065 096 000060 | <b>MEPCDL2.5</b><br>MPDL2,5 için Çift Katlı Yan Kapak Push-in Tip       | 10         | 0,53 \$    |
| 065 096 000076 | <b>MEPCDL4</b><br>MDL4UN için Yan Kapak Vidalı Tip                      | 10         | 0,83 \$    |
| 065 096 000202 | <b>MEPCMC1-2</b><br>MMC1-2 için Yan Kapak Vidalı Tip                    | 50         | 0,53 \$    |
| 065 096 000204 | <b>MEPCMC2-2</b><br>MMC2-2 için Yan Kapak Vidalı Tip                    | 50         | 0,61 \$    |
| 065 096 000206 | <b>MEPODL2.5</b><br>MDL2,5A için Yan Kapak Vidalı Tip                   | 50         | 0,58 \$    |
| 065 096 000208 | <b>MEPCDS6U</b><br>MS6U/TS için Yan Kapak Vidalı Tip                    | 50         | 0,93 \$    |
| 065 096 000210 | <b>MEPCX4/3</b><br>MP4/3 için Yan Kapak Push-in Tip                     | 50         | 0,58 \$    |
| 065 096 000212 | <b>MEPCX4/4</b><br>MP4/4 için Yan Kapak Push-in Tip                     | 50         | 0,55 \$    |
| 065 096 000214 | <b>MEPCX6/3</b><br>MP6/10/3 için Yan Kapak Push-in Tip                  | 50         | 0,58 \$    |
| 065 096 000216 | <b>MEPCPTL2.5</b><br>MPTL2,5 için Yan Kapak Push-in Tip                 | 50         | 0,75 \$    |
| 065 096 000218 | <b>MEPCPPT2.5/3</b><br>MPST1,5/3 için Yan Kapak Push-in Tip             | 50         | 1,25 \$    |
| 065 096 000220 | <b>MEPCPPT2.5/4</b><br>MPST1,5/4 için Yan Kapak Push-in Tip             | 50         | 1,51 \$    |
| 065 096 000221 | <b>MEPCPDLK2.5</b><br>MPDLK2,5 için Yan Kapak Push-in Tip               | 50         | 0,93 \$    |

## RAY KLEMENS İÇİN DEKAFİKLER

| Ürün Kodu      | Ürün Adı                              | Kutu Adedi | Fiyat (\$) |
|----------------|---------------------------------------|------------|------------|
| 065 096 000100 | MC3.5 1,5 mm için Dekafix - Yazısız   | 1200       | 0,05 \$    |
| 065 096 000101 | MC3.5 1,5 mm için Dekafix (1-50)      | 1200       | 0,05 \$    |
| 065 096 000222 | MC3.5 1,5 mm için Dekafix (51-99)     | 1200       | 0,05 \$    |
| 065 096 000223 | MC3.5 1,5 mm için Dekafix (+-)        | 1200       | 0,05 \$    |
| 065 096 000224 | MC3.5 1,5 mm için Dekafix (L,N,PE)    | 1200       | 0,05 \$    |
| 065 096 000102 | MC5 2,5 mm için Dekafix- Yazısız      | 840        | 0,05 \$    |
| 065 096 000103 | MC5 2,5 mm için Dekafix (1-50)        | 840        | 0,05 \$    |
| 065 096 000225 | MC5 2,5 mm için Dekafix (51-99)       | 840        | 0,05 \$    |
| 065 096 000226 | MC5 2,5 mm için Dekafix (+-)          | 840        | 0,05 \$    |
| 065 096 000227 | MC5 2,5 mm için Dekafix (L,N,PE)      | 840        | 0,05 \$    |
| 065 096 000104 | MC6 4 mm için Dekafix - Yazısız       | 720        | 0,05 \$    |
| 065 096 000105 | MC6 4 mm için Dekafix (1-50)          | 720        | 0,05 \$    |
| 065 096 000228 | MC6 4 mm için Dekafix (51-99)         | 720        | 0,05 \$    |
| 065 096 000229 | MC6 4 mm için Dekafix (+-)            | 720        | 0,05 \$    |
| 065 096 000230 | MC6 4 mm için Dekafix (L,N,PE)        | 720        | 0,05 \$    |
| 065 096 000106 | MC8 6 mm için Dekafix - Yazısız       | 480        | 0,05 \$    |
| 065 096 000107 | MC8 6 mm için Dekafix (1-50)          | 480        | 0,05 \$    |
| 065 096 000231 | MC8 6 mm için Dekafix (51-99)         | 480        | 0,05 \$    |
| 065 096 000232 | MC8 6 mm için Dekafix (+-)            | 480        | 0,05 \$    |
| 065 096 000233 | MC8 6 mm için Dekafix (L,N,PE)        | 480        | 0,05 \$    |
| 065 096 000108 | MC10 10 mm için Dekafix - Yazısız     | 420        | 0,05 \$    |
| 065 096 000109 | MC10 10 mm için Dekafix (1-50)        | 420        | 0,05 \$    |
| 065 096 000234 | MC10 10 mm için Dekafix (51-99)       | 420        | 0,05 \$    |
| 065 096 000235 | MC10 10 mm için Dekafix (+-)          | 420        | 0,05 \$    |
| 065 096 000236 | MC10 10 mm için Dekafix (L,N,PE)      | 420        | 0,05 \$    |
| 065 096 000110 | MC12 16 mm için Dekafix - Yazısız     | 360        | 0,05 \$    |
| 065 096 000111 | MC12 16 mm için Dekafix (1-50)        | 360        | 0,05 \$    |
| 065 096 000237 | MC12 16 mm için Dekafix (51-99)       | 360        | 0,05 \$    |
| 065 096 000238 | MC12 16 mm için Dekafix (+-)          | 360        | 0,05 \$    |
| 065 096 000239 | MC12 16 mm için Dekafix (L,N,PE)      | 360        | 0,05 \$    |
| 065 096 000112 | MC16 35-120 mm için Dekafix - Yazısız | 240        | 0,05 \$    |
| 065 096 000113 | MC16 35-120 mm için Dekafix (1-50)    | 240        | 0,05 \$    |
| 065 096 000240 | MC16 35-120 mm için Dekafix (51-99)   | 240        | 0,05 \$    |
| 065 096 000241 | MC16 35-120 mm için Dekafix (+-)      | 240        | 0,05 \$    |
| 065 096 000242 | MC16 35-120 mm için Dekafix (L,N,PE)  | 240        | 0,05 \$    |

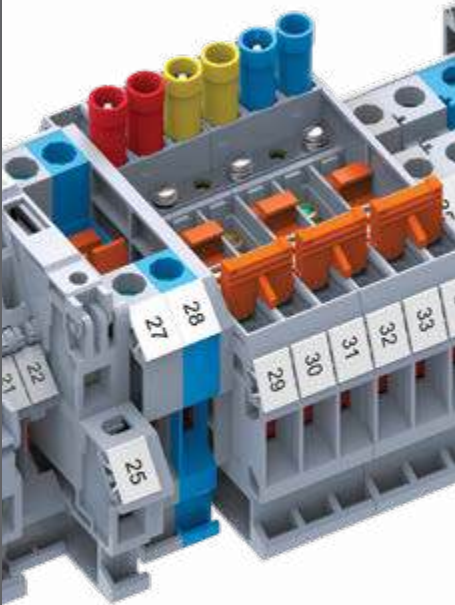

# Promex

## ETİKET MAKİNESİ



### 60 Metrelik Şerit Etiket için Maksimum Baskı;

- 1,5 mm<sup>2</sup> için 17.000
- 2,5 mm<sup>2</sup> için 12.000
- 4 mm<sup>2</sup> için 10.000
- 6 mm<sup>2</sup> için 7.500
- 10 mm<sup>2</sup> için 6.000

**3x20  
METRE**



## ETİKET MAKİNESİ ve AKSESUARLARI

| Ürün Kodu      | Ürün Adı                           | Kutu Adedi | Fiyat (\$) |
|----------------|------------------------------------|------------|------------|
| 065 096 000124 | Promex Etiket Makinesi             | 1          | 925,93 \$  |
| 065 096 000129 | Promex Şerit Etiketi 20 m (3x20 m) | 1          | 37,04 €    |
| 065 096 000130 | Promex Etiketi - 27x12 mm - Gümüş  | 1          | 0,35 €     |
| 065 096 000132 | Promex Etiketi - 15x6 mm - Gümüş   | 1          | 0,28 €     |
| 065 096 000134 | Promex Ribon - Siyah               | 1          | 74,07 €    |
| 065 096 000136 | Promex Ribon - Kırmızı             | 1          | 101,85 €   |
| 065 096 000138 | Promex Ribon - Mavi                | 1          | 101,85 €   |



## ISIYLA DARALAN MAKARONLAR

| Ürün Kodu      | Ürün Adı            | Kutu Adedi | Fiyat (\$)    |
|----------------|---------------------|------------|---------------|
| 065 096 000310 | 3 mm Makaron - Sarı | 200 m.     | FİYAT SORUNUZ |
| 065 096 000312 | 4 mm Makaron - Sarı | 100 m.     |               |
| 065 096 000314 | 6 mm Makaron - Sarı | 100 m.     |               |



## ŞEFFAF TÜP ve ETİKETLERİ

| Ürün Kodu      | Ürün Adı   | Kutu Adedi | Fiyat (\$)    |
|----------------|--|------------|---------------|
| 065 096 000300 | 20x4 mm Şeffaf Tüp Etiketi - Sarı                          | 1000       | FİYAT SORUNUZ |
| 065 096 000302 | 20 mm Şeffaf Tüp (0,5 - 1,5 mm <sup>2</sup> Kablolar için) | 500        |               |
| 065 096 000304 | 20 mm Şeffaf Tüp (1,5 - 2,5 mm <sup>2</sup> Kablolar için) | 500        |               |
| 065 096 000306 | 20 mm Şeffaf Tüp (2,5 - 4,0 mm <sup>2</sup> Kablolar için) | 500        |               |
| 065 096 000308 | 20 mm Şeffaf Tüp (4,0 - 6,0 mm <sup>2</sup> Kablolar için) | 500        |               |



# ALEV YAYMAYAN SIRA KLEMENSLER

Güvenli Bağlantılar İçin İdeal Seçim!

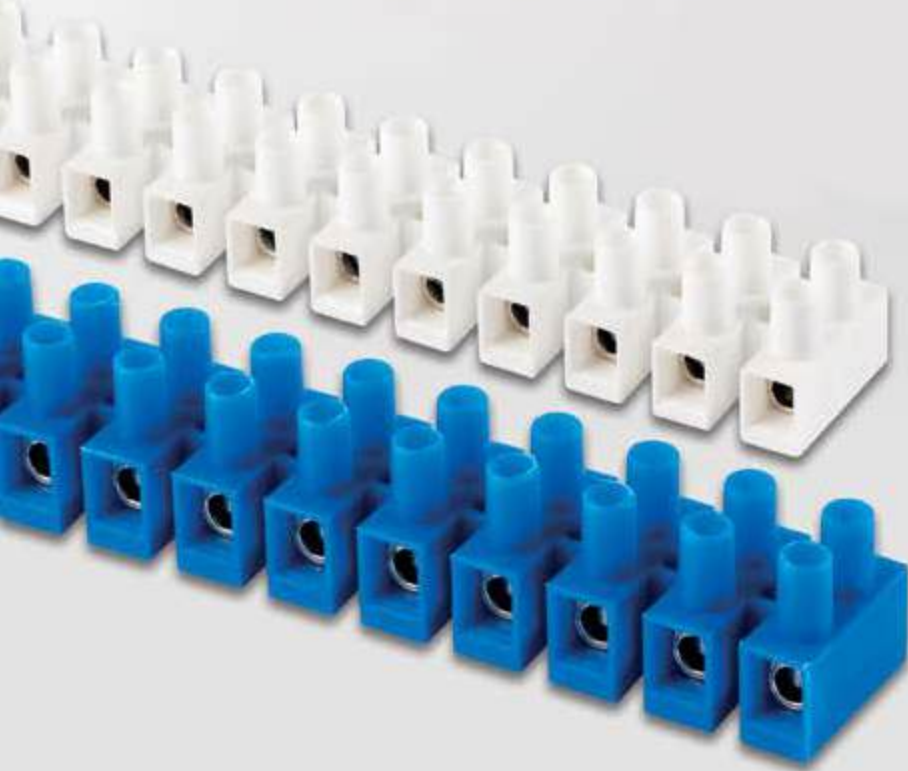

**850°C**  
**ALEV YAYMAZLIK**

## 750° ALEV YAYMAYAN SIRA KLEMENSLER (MAVİ)



| Ürün Kodu      | Ürün Adı  | Kutu Adet | Koli Adet | Fiyat (₺) |
|----------------|---|-----------|-----------|-----------|
| 015 094 150001 | NO.1 750° ALEV YAYMAYAN SIRA KLEMENS (2.5-4 mm <sup>2</sup> ) | 50        | 600       | 55,91     |
| 015 094 150002 | NO.2 750° ALEV YAYMAYAN SIRA KLEMENS (4-6 mm <sup>2</sup> )   | 50        | 400       | 72,93     |
| 015 094 150003 | NO.3 750° ALEV YAYMAYAN SIRA KLEMENS (6-10 mm <sup>2</sup> )  | 50        | 300       | 97,74     |
| 015 094 150004 | NO.4 750° ALEV YAYMAYAN SIRA KLEMENS (10-16 mm <sup>2</sup> ) | 50        | 400       | 100,24    |
| 015 094 150005 | NO.5 750° ALEV YAYMAYAN SIRA KLEMENS (16-25 mm <sup>2</sup> ) | 50        | 300       | 118,15    |

## 850° ALEV YAYMAYAN SIRA KLEMENSLER (BEYAZ)



| Ürün Kodu      | Ürün Adı  | Kutu Adet | Koli Adet | Fiyat (₺) |
|----------------|---|-----------|-----------|-----------|
| 015 094 170001 | NO.1 850° ALEV YAYMAYAN SIRA KLEMENS (2.5-4 mm <sup>2</sup> ) | 50        | 600       | 59,52     |
| 015 094 170002 | NO.2 850° ALEV YAYMAYAN SIRA KLEMENS (4-6 mm <sup>2</sup> )   | 50        | 400       | 77,56     |
| 015 094 170003 | NO.3 850° ALEV YAYMAYAN SIRA KLEMENS (6-10 mm <sup>2</sup> )  | 50        | 300       | 105,93    |
| 015 094 170004 | NO.4 850° ALEV YAYMAYAN SIRA KLEMENS (10-16 mm <sup>2</sup> ) | 50        | 400       | 106,43    |
| 015 094 170005 | NO.5 850° ALEV YAYMAYAN SIRA KLEMENS (16-25 mm <sup>2</sup> ) | 50        | 300       | 130,37    |

# GEÇMELİ ve TIRNAK TİP BUAT KLEMENSLER



| Ürün Kodu                                     | Ürün Adı   | Kutu Adet | Koli Adet | Fiyat   |
|---|--|-----------|-----------|---------|
| <b>SWISS GEÇMELİ BUAT KLEMENS</b>             |  |           |           | €       |
| 999 094 225000                                | 2'Lİ GEÇMELİ BUAT KLEMENS (0,5-2,5 mm <sup>2</sup> ) | 100       | 6000      | 0,14 \$ |
| 999 094 325000                                | 3'LÜ GEÇMELİ BUAT KLEMENS (0,5-2,5 mm <sup>2</sup> ) | 100       | 6000      | 0,14 \$ |
| 999 094 425000                                | 4'LÜ GEÇMELİ BUAT KLEMENS (0,5-2,5 mm <sup>2</sup> ) | 100       | 6000      | 0,17 \$ |
| 999 094 525000                                | 5'Lİ GEÇMELİ BUAT KLEMENS (0,5-2,5 mm <sup>2</sup> ) | 100       | 6000      | 0,19 \$ |
| 999 094 625000                                | 6'Lİ GEÇMELİ BUAT KLEMENS (0,5-2,5 mm <sup>2</sup> ) | 50        | 2500      | 0,26 \$ |
| 999 094 825000                                | 8'Lİ GEÇMELİ BUAT KLEMENS (0,5-2,5 mm <sup>2</sup> ) | 50        | 2500      | 0,29 \$ |
| <b>SWISS TIRNAKLI BUAT KLEMENS</b>            |  |           |           | €       |
| 999 094 241000                                | 2'Lİ TIRNAKLI BUAT KLEMENS (0,2-4 mm <sup>2</sup> )  | 100       | 5000      | 0,26 \$ |
| 999 094 341000                                | 3'LÜ TIRNAKLI BUAT KLEMENS (0,2-4 mm <sup>2</sup> )  | 100       | 5000      | 0,35 \$ |
| 999 094 441000                                | 4-LÜ TIRNAKLI BUAT KLEMENS (0,2-4 mm <sup>2</sup> )  | 50        | 2500      | 0,42 \$ |
| 999 094 541000                                | 5'Lİ TIRNAKLI BUAT KLEMENS (0,2-4 mm <sup>2</sup> )  | 50        | 2500      | 0,50 \$ |
| <b>ŞEFFAF ISIYA DAYANIKLI BUAT KLEMENSLER</b> |  |           |           | €       |
| 888 094 000105                                | NO.2 ŞEFFAF BUAT KLEMENS (1 ADET FİYAT)              | 560       |           | 9,41    |
| 888 094 000205                                | NO.3 ŞEFFAF BUAT KLEMENS (1 ADET FİYAT)              | 360       |           | 13,32   |
| 888 094 000405                                | NO.4 ŞEFFAF BUAT KLEMENS (1 ADET FİYAT)              | 200       |           | 21,91   |
| 888 094 000605                                | NO.5 ŞEFFAF BUAT KLEMENS (1 ADET FİYAT)              | 120       |           | 29,64   |
| <b>PORSELEN KLEMENSLER</b>                    |  |           |           | €       |
| 015 094 180002                                | NO. 1-2'Lİ PORSELEN KLEMENS (2,5-4 mm <sup>2</sup> ) | 396       | 1584      | 24,26   |
| 015 094 180003                                | NO. 1-3'LÜ PORSELEN KLEMENS (2,5-4 mm <sup>2</sup> ) | 264       | 1056      | 29,46   |
| 015 094 180004                                | NO. 2-2'Lİ PORSELEN KLEMENS (4-6 mm <sup>2</sup> )   | 250       | 1000      | 29,46   |
| 015 094 180005                                | NO. 2-3'LÜ PORSELEN KLEMENS (4-6 mm <sup>2</sup> )   | 150       | 600       | 42,16   |
| 015 094 180006                                | NO. 3-2'Lİ PORSELEN KLEMENS (6-10 mm <sup>2</sup> )  | 128       | 512       | 42,16   |
| 015 094 180007                                | NO. 3-3'LÜ PORSELEN KLEMENS (6-10 mm <sup>2</sup> )  | 84        | 336       | 65,00   |
| <b>GEÇMELİ SOKET KLEMENSLER</b>               |  |           |           | €       |
| 999 999 991212                                | 12'Lİ GEÇMELİ SOKET KLEMENS (850°C ALEV YAYMAYAN )   | 25        | 500       | 284,72  |
| <b>U KLEMENSLER</b>                           |  |           |           | €       |
| 014 094 030006                                | 6'LİK U KLEMENS                                      | 300       |           | 63,66   |
| 014 094 030010                                | 10'LUK U KLEMENS                                     | 250       |           | 86,57   |
| 014 094 030016                                | 16'LİK U KLEMENS                                     | 100       |           | 132,41  |
| 014 094 030025                                | 25'LİK U KLEMENS                                     | 100       |           | 157,87  |
| 014 094 030035                                | 35'LİK U KLEMENS                                     | 75        |           | 183,33  |
| 014 094 030050                                | 50'LİK U KLEMENS                                     | 50        |           | 290,28  |
| 014 094 030070                                | 70'LİK U KLEMENS                                     | 40        |           | 376,85  |
| 014 094 030095                                | 95'LİK U KLEMENS                                     | 25        |           | 468,52  |
| 014 094 030120                                | 120'LİK U KLEMENS                                    | 20        |           | 611,11  |
| 014 094 030150                                | 150'LİK U KLEMENS                                    | 15        |           | 789,35  |

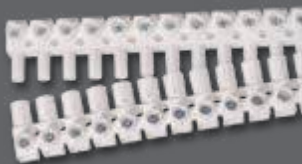

### PANO TOPRAKLAMA KLEMENLERİ (6x8 mm) 63A

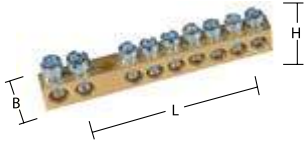

| Ürün Kodu      | Ürün Adı                         | L | B | H  | Kutu Adet | Fiyat (₺) |
|----------------|----------------------------------|---|---|----|-----------|-----------|
| 014 102 006304 | 4 DELİK PANO TOPRAKLAMA KLEMENS  | 6 | 8 | 33 | 100       | 57,20     |
| 014 102 006305 | 5 DELİK PANO TOPRAKLAMA KLEMENS  | 6 | 8 | 38 | 100       | 64,35     |
| 014 102 006306 | 6 DELİK PANO TOPRAKLAMA KLEMENS  | 6 | 8 | 45 | 100       | 76,80     |
| 014 102 006307 | 7 DELİK PANO TOPRAKLAMA KLEMENS  | 6 | 8 | 50 | 100       | 84,08     |
| 014 102 006309 | 9 DELİK PANO TOPRAKLAMA KLEMENS  | 6 | 8 | 62 | 100       | 96,53     |
| 014 102 006310 | 10 DELİK PANO TOPRAKLAMA KLEMENS | 6 | 8 | 68 | 100       | 117,84    |
| 014 102 006312 | 12 DELİK PANO TOPRAKLAMA KLEMENS | 6 | 8 | 80 | 100       | 143,00    |

### PANO TOPRAKLAMA KLEMENLERİ AYAKLI (6,5X9 mm) 80A

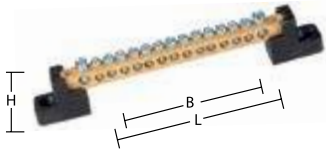

| Ürün Kodu      | Ürün Adı                        | L   | B   | H  | Kutu Adet | Fiyat (₺) |
|----------------|---------------------------------|-----|-----|----|-----------|-----------|
| 014 102 008006 | 6 DELİK AYAKLI DAĞITIM ÜNİTESİ  | 85  | 70  | 22 | 200       | 135,85    |
| 014 102 008010 | 10 DELİK AYAKLI DAĞITIM ÜNİTESİ | 108 | 95  | 22 | 150       | 178,75    |
| 014 102 008012 | 12 DELİK AYAKLI DAĞITIM ÜNİTESİ | 120 | 106 | 22 | 150       | 193,31    |
| 014 102 008015 | 15 DELİK AYAKLI DAĞITIM ÜNİTESİ | 138 | 124 | 22 | 125       | 230,39    |
| 014 102 008020 | 20 DELİK AYAKLI DAĞITIM ÜNİTESİ | 165 | 152 | 22 | 100       | 304,54    |

### 1 KUTUP DAĞITIM ÜNİTESİ 125A

CE

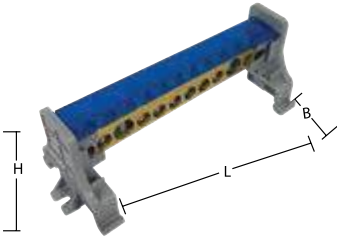

| Ürün Kodu      | Ürün Adı                     | Cinsi | L   | B  | H  | Koli Adet | Fiyat (₺) |
|----------------|------------------------------|-------|-----|----|----|-----------|-----------|
| 014 102 112507 | 125A 1 KUTUP DAĞITIM ÜNİTESİ | 2+5   | 76  | 44 | 42 | 70        | 321,75    |
| 014 102 112510 | 125A 1 KUTUP DAĞITIM ÜNİTESİ | 2+8   | 100 | 44 | 42 | 60        | 376,04    |
| 014 102 112512 | 125A 1 KUTUP DAĞITIM ÜNİTESİ | 2+10  | 115 | 44 | 42 | 55        | 429,00    |
| 014 102 112515 | 125A 1 KUTUP DAĞITIM ÜNİTESİ | 2+13  | 135 | 44 | 42 | 45        | 548,17    |
| 014 102 112520 | 125A 1 KUTUP DAĞITIM ÜNİTESİ | 2+18  | 170 | 44 | 42 | 35        | 677,93    |
| 014 102 112522 | 125A 1 KUTUP DAĞITIM ÜNİTESİ | 2+20  | 185 | 44 | 42 | 35        | 752,07    |

### 2 KUTUP DAĞITIM ÜNİTESİ 125A

CE

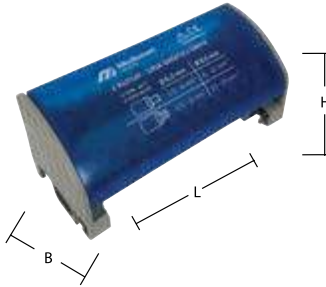

| Ürün Kodu      | Ürün Adı                     | Cinsi | L   | B  | H  | Koli Adet | Fiyat (₺) |
|----------------|------------------------------|-------|-----|----|----|-----------|-----------|
| 014 102 212507 | 125A 2 KUTUP DAĞITIM ÜNİTESİ | 2+5   | 81  | 90 | 50 | 22        | 662,04    |
| 014 102 212510 | 125A 2 KUTUP DAĞITIM ÜNİTESİ | 2+8   | 103 | 90 | 50 | 15        | 715,00    |
| 014 102 212512 | 125A 2 KUTUP DAĞITIM ÜNİTESİ | 2+10  | 118 | 90 | 50 | 14        | 794,44    |
| 014 102 212515 | 125A 2 KUTUP DAĞITIM ÜNİTESİ | 2+13  | 142 | 90 | 50 | 12        | 1.019,54  |
| 014 102 212520 | 125A 2 KUTUP DAĞITIM ÜNİTESİ | 2+18  | 178 | 90 | 50 | 6         | 1.276,41  |

### 4 KUTUP DAĞITIM ÜNİTESİ 125A

CE

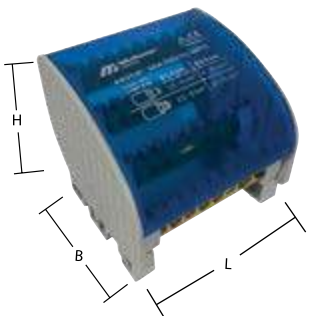

| Ürün Kodu      | Ürün Adı                     | Cinsi | L   | B  | H  | Koli Adet | Fiyat (₺) |
|----------------|------------------------------|-------|-----|----|----|-----------|-----------|
| 014 102 412507 | 125A 4 KUTUP DAĞITIM ÜNİTESİ | 2+5   | 60  | 80 | 75 | 10        | 1.233,38  |
| 014 102 412510 | 125A 4 KUTUP DAĞITIM ÜNİTESİ | 2+8   | 83  | 80 | 75 | 8         | 1.340,63  |
| 014 102 412512 | 125A 4 KUTUP DAĞITIM ÜNİTESİ | 2+10  | 97  | 80 | 75 | 6         | 1.483,63  |
| 014 102 412515 | 125A 4 KUTUP DAĞITIM ÜNİTESİ | 2+13  | 120 | 80 | 75 | 5         | 1.840,46  |
| 014 102 412520 | 125A 4 KUTUP DAĞITIM ÜNİTESİ | 2+18  | 155 | 80 | 75 | 4         | 2.395,25  |
| 014 102 412522 | 125A 4 KUTUP DAĞITIM ÜNİTESİ | 2+20  | 170 | 80 | 75 | 4         | 2.556,13  |
| 014 102 412525 | 125A 4 KUTUP DAĞITIM ÜNİTESİ | 2+23  | 191 | 80 | 75 | 4         | 2.948,71  |



# KABLO BAĞLARI

Kendinden Kilitlemeli Sistem  
Kolay ve Hızlı Montaj  
1.Sınıf Malzeme



| Siyah Ürün Kodu  | Genişlik X Uzunluk (mm) | Taşıma Kapasitesi       |                   | Ürün Adı   | Kutu Adet | Koli Adet | Fiyat (₺) |           |
|--|-------------------------|-------------------------|-------------------|------------|-----------|-----------|-----------|-----------|
|  |                         | kg                      | lbs               |            |           |           |           |           |
| <b>ULTRAVİYOLE KABLO BAĞLARI (SİYAH)</b>  |                         |                         |                   |            |           |           |           |           |
| 062 129 225100   | 2,5x100                 | 12                      | 26                | KABLO BAĞI | 1000 ad.  | 60.000    | 0,38      |           |
| 062 129 225140   | 2,5x140                 | 12                      | 26                | KABLO BAĞI | 100 ad.   | 35.000    | 0,58      |           |
| 062 129 225200   | 2,5x200                 | 12                      | 26                | KABLO BAĞI | 100 ad.   | 25.000    | 0,83      |           |
| 062 129 236150   | 3,6x150                 | 18                      | 26                | KABLO BAĞI | 100 ad.   | 25.000    | 0,98      |           |
| 062 129 236205   | 3,6x205                 | 18                      | 40                | KABLO BAĞI | 100 ad.   | 20.000    | 1,33      |           |
| 062 129 236250   | 3,6x250                 | 18                      | 40                | KABLO BAĞI | 100 ad.   | 18.000    | 1,60      |           |
| 062 129 236300   | 3,6x300                 | 18                      | 40                | KABLO BAĞI | 100 ad.   | 15.000    | 2,03      |           |
| 062 129 236370   | 3,6x370                 | 18                      | 40                | KABLO BAĞI | 100 ad.   | 12.000    | 2,55      |           |
| 062 129 248200   | 4,8x200                 | 25                      | 40                | KABLO BAĞI | 100 ad.   | 12.000    | 1,96      |           |
| 062 129 248250   | 4,8x250                 | 25                      | 55                | KABLO BAĞI | 100 ad.   | 12.000    | 2,29      |           |
| 062 129 248300   | 4,8x300                 | 25                      | 55                | KABLO BAĞI | 100 ad.   | 11.000    | 2,88      |           |
| 062 129 248350   | 4,8x350                 | 25                      | 55                | KABLO BAĞI | 100 ad.   | 9.000     | 3,33      |           |
| 062 129 248400   | 4,8x400                 | 25                      | 55                | KABLO BAĞI | 100 ad.   | 8.000     | 3,79      |           |
| 062 129 248450   | 4,8x450                 | 25                      | 55                | KABLO BAĞI | 100 ad.   | 6.000     | 4,51      |           |
| 062 129 208250   | 8x250                   | 55                      | 55                | KABLO BAĞI | 100 ad.   | 6.000     | 4,58      |           |
| 062 129 208300   | 8x300                   | 55                      | 121               | KABLO BAĞI | 100 ad.   | 5.000     | 6,08      |           |
| 062 129 208380   | 8x380                   | 55                      | 121               | KABLO BAĞI | 100 ad.   | 5.000     | 6,54      |           |
| 062 129 208450   | 8x450                   | 55                      | 121               | KABLO BAĞI | 100 ad.   | 3.500     | 7,32      |           |
| 062 129 208550   | 8x550                   | 55                      | 121               | KABLO BAĞI | 100 ad.   | 2.500     | 9,81      |           |
| 062 129 208750   | 8x750                   | 55                      | 121               | KABLO BAĞI | 100 ad.   | 2.000     | 15,69     |           |
| 062 129 209762   | 9x762                   | 80                      | 177               | KABLO BAĞI | 100 ad.   | 1.500     | 20,92     |           |
| 062 129 209940   | 9x940                   | 80                      | 177               | KABLO BAĞI | 100 ad.   | 1.500     | 24,19     |           |
| Beyaz Ürün Kodu  | Siyah Ürün Kodu         | Genişlik X Uzunluk (mm) | Taşıma Kapasitesi |            | Ürün Adı  | Kutu Adet | Koli Adet | Fiyat (₺) |
|  |                         |                         | kg                | lbs        |           |           |           |           |

## MUTLUSAN KABLO BAĞLARI (SİYAH-BEYAZ)

|                |                |         |    |     |            |          |        |       |
|----------------|----------------|---------|----|-----|------------|----------|--------|-------|
| 062 129 025100 | 062 129 125100 | 2,5x100 | 12 | 26  | KABLO BAĞI | 1000 ad. | 60.000 | 0,35  |
| 062 129 025140 | 062 129 125140 | 2,5x140 | 12 | 26  | KABLO BAĞI | 100 ad.  | 35.000 | 0,52  |
| 062 129 025200 | 062 129 125200 | 2,5x200 | 12 | 26  | KABLO BAĞI | 100 ad.  | 25.000 | 0,76  |
| 062 129 036150 | 062 129 136150 | 3,6x150 | 18 | 26  | KABLO BAĞI | 100 ad.  | 25.000 | 0,89  |
| 062 129 036205 | 062 129 136205 | 3,6x205 | 18 | 40  | KABLO BAĞI | 100 ad.  | 20.000 | 1,21  |
| 062 129 036250 | 062 129 136250 | 3,6x250 | 18 | 40  | KABLO BAĞI | 100 ad.  | 18.000 | 1,45  |
| 062 129 036300 | 062 129 136300 | 3,6x300 | 18 | 40  | KABLO BAĞI | 100 ad.  | 15.000 | 1,84  |
| 062 129 036370 | 062 129 136370 | 3,6x370 | 18 | 40  | KABLO BAĞI | 100 ad.  | 12.000 | 2,32  |
| 062 129 048200 | 062 129 148200 | 4,8x200 | 25 | 40  | KABLO BAĞI | 100 ad.  | 12.000 | 1,78  |
| 062 129 048250 | 062 129 148250 | 4,8x250 | 25 | 55  | KABLO BAĞI | 100 ad.  | 12.000 | 2,08  |
| 062 129 048300 | 062 129 148300 | 4,8x300 | 25 | 55  | KABLO BAĞI | 100 ad.  | 11.000 | 2,62  |
| 062 129 048350 | 062 129 148350 | 4,8x350 | 25 | 55  | KABLO BAĞI | 100 ad.  | 9.000  | 3,03  |
| 062 129 048400 | 062 129 148400 | 4,8x400 | 25 | 55  | KABLO BAĞI | 100 ad.  | 8.000  | 3,45  |
| 062 129 048450 | 062 129 148450 | 4,8x450 | 25 | 55  | KABLO BAĞI | 100 ad.  | 6.000  | 4,10  |
| 062 129 008250 | 062 129 108250 | 8x250   | 55 | 55  | KABLO BAĞI | 100 ad.  | 6.000  | 4,16  |
| 062 129 008300 | 062 129 108300 | 8x300   | 55 | 121 | KABLO BAĞI | 100 ad.  | 5.000  | 5,53  |
| 062 129 008380 | 062 129 108380 | 8x380   | 55 | 121 | KABLO BAĞI | 100 ad.  | 5.000  | 5,94  |
| 062 129 008450 | 062 129 108450 | 8x450   | 55 | 121 | KABLO BAĞI | 100 ad.  | 3.500  | 6,66  |
| 062 129 008550 | 062 129 108550 | 8x550   | 55 | 121 | KABLO BAĞI | 100 ad.  | 2.500  | 8,92  |
| 062 129 008750 | 062 129 108750 | 8x750   | 55 | 121 | KABLO BAĞI | 100 ad.  | 2.000  | 14,27 |
| 062 129 009762 | 062 129 109762 | 9x762   | 80 | 177 | KABLO BAĞI | 100 ad.  | 1.500  | 18,99 |
| 062 129 009940 | 062 129 109940 | 9x940   | 80 | 177 | KABLO BAĞI | 100 ad.  | 1.500  | 21,99 |



STANDART TİP



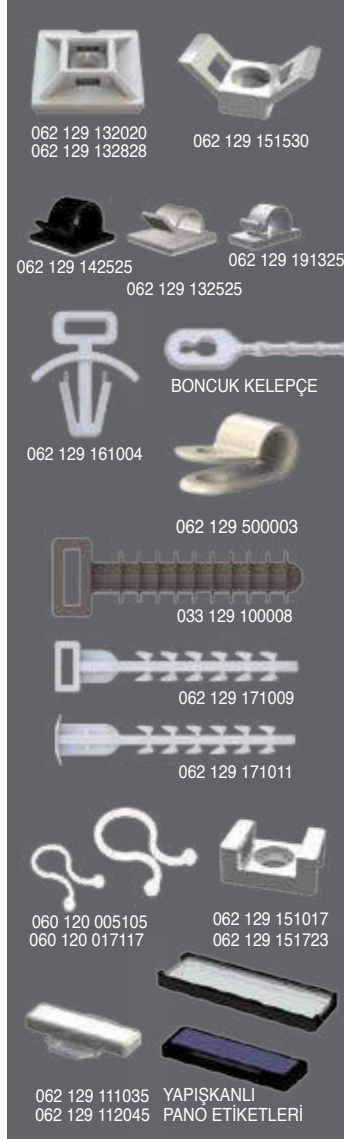

| Ürün Kodu                | Ürün Adı                          | Kutu Adet | Koli Adet | Fiyat (₺) |
|--------------------------|-----------------------------------|-----------|-----------|-----------|
| <b>KROŞE VE KLİPSLER</b> |                                   |           |           |           |
| 062 129 132020           | 20x20 mm YAPIŞKANLI KROŞE         | 100 ad.   | 20.000    | 2,25      |
| 062 129 132828           | 28x28 mm YAPIŞKANLI KROŞE         | 100 ad.   | 9.000     | 3,84      |
| 062 129 131316           | 13x16 mm YAPIŞKANLI KLİPS         | 100 ad.   | 7.000     | 2,45      |
| 062 129 191325           | 13x25 mm YAPIŞKANLI KLİPS         | 100 ad.   | 5.000     | 3,31      |
| 062 129 132525           | 25x25 mm YAPIŞKANLI KLİPS (BEYAZ) | 100 ad.   | 3.000     | 5,21      |
| 062 129 142525           | 25x25 mm YAPIŞKANLI KLİPS (SİYAH) | 100 ad.   | 2.000     | 5,56      |
| 062 129 151017           | 10x17 mm VİDALI KROŞE             | 250 ad.   | 12.500    | 1,80      |
| 062 129 151530           | 15x30 mm VİDALI KROŞE             | 100 ad.   | 5.000     | 2,78      |
| 062 129 151723           | 17x23 mm VİDALI KROŞE             | 250 ad.   | 5.000     | 2,26      |
| 062 129 161004           | DÜBELLİ KROŞE 6 DELİK İÇİN        | 500 ad.   | 15.000    | 1,30      |
| 062 129 171009           | DUVAR KROŞESİ 6 DELİK İÇİN        | 250 ad.   | 7.500     | 2,18      |
| 033 129 100008           | DUVAR KROŞESİ 8 DELİK İÇİN        | 250 ad.   | 9.000     | 2,50      |
| 062 129 171011           | KANAL KROŞESİ 6 DELİK İÇİN        | 250 ad.   | 7.500     | 2,18      |
| 062 129 500003           | KABLO KLİPSİ 6,4 (1/4")           | 100 ad.   | 10.000    | 1,45      |
| 062 129 500004           | KABLO KLİPSİ 7,9 (5/16")          | 100 ad.   | 5.000     | 1,63      |
| 062 129 500005           | KABLO KLİPSİ 10,9 (3/8")          | 100 ad.   | 5.000     | 1,81      |
| <b>KELEPÇELER</b>        |                                   |           |           |           |
| 062 129 010101           | 2x105 mm BONCUK KELEPÇE           | 1000 ad.  | 25.000    | 0,77      |
| 062 129 010102           | 3,5x165 mm BONCUK KELEPÇE         | 500 ad.   | 8.000     | 1,73      |
| 062 129 500000           | 3,5x235 mm BONCUK KELEPÇE         | 100 ad.   | 5.000     | 2,76      |
| 060 120 005105           | 4,5 mm BURMA KELEPÇE              | 500 ad.   | 50.000    | 0,87      |
| 060 120 007107           | 7,0 mm BURMA KELEPÇE              | 500 ad.   | 45.000    | 1,06      |
| 060 120 010110           | 10,5 mm BURMA KELEPÇE             | 500 ad.   | 35.000    | 1,30      |
| 060 120 014114           | 14 mm BURMA KELEPÇE               | 500 ad.   | 30.000    | 1,36      |
| 060 120 017117           | 17 mm BURMA KELEPÇE               | 500 ad.   | 15.000    | 1,50      |
| <b>ETİKETLER</b>         |                                   |           |           |           |
| 062 129 111035           | 10X35 mm KABLO BAĞI ETİKETİ       | 100 ad.   | 4.000     | 3,70      |
| 062 129 112045           | 20X45 mm KABLO BAĞI ETİKETİ       | 100 ad.   | 1.500     | 7,41      |
| 062 129 121730           | 17X30 mm YAPIŞKANLI PANO ETİKETİ  | 100 ad.   | 4.000     | 4,79      |
| 062 129 121750           | 17X50 mm YAPIŞKANLI PANO ETİKETİ  | 50 ad.    | 2.000     | 6,44      |
| 062 129 122075           | 17X75 mm YAPIŞKANLI PANO ETİKETİ  | 25 ad.    | 1.500     | 8,66      |

## KABLO TOPLAMA SİRİRALİ (GRİ - SİYAH)

XX yerine 00 Gri / XX yerine 11 Siyah

| Ürün Kodu      | Ürün Adı                                       | Amb. Birimi | Koli Adedi | Ad. /Mt. Fiyat (\$) |
|----------------|--|-------------|------------|---------------------|
| 888 020 9XX003 | R1034 16 mm KABLO TOPLAMA SİRİRALİ (1,5m VAK)  | 1 ad.       | 60         | 6,88 \$             |
| 888 020 9XX006 | R1035 22 mm KABLO TOPLAMA SİRİRALİ (1,5m VAK)  | 1 ad.       | 40         | 9,32 \$             |
| 888 020 9XX009 | R1036 28 mm KABLO TOPLAMA SİRİRALİ (1,5m VAK)  | 1 ad.       | 35         | 12,04 \$            |
| 888 020 9XX001 | R1033 10 mm KABLO TOPLAMA SİRİRALİ (50 m RULO) | 50 mt.      | 200        | 2,87 \$             |
| 888 020 9XX004 | R1034 16 mm KABLO TOPLAMA SİRİRALİ (25 m RULO) | 25 mt.      | 100        | 3,51 \$             |
| 888 020 9XX007 | R1035 22 mm KABLO TOPLAMA SİRİRALİ (20 m RULO) | 20 mt.      | 80         | 4,95 \$             |
| 888 020 9XX010 | R1036 28 mm KABLO TOPLAMA SİRİRALİ (15 m RULO) | 15 mt.      | 60         | 6,29 \$             |
| 888 020 9XX011 | R1037 34 mm KABLO TOPLAMA SİRİRALİ (25 m RULO) | 25 mt.      | 50         | 7,33 \$             |

## HELEZON PANO SİRİRALİ

XX yerine 00 Şeffaf / XX yerine 11 Siyah

| Ürün Kodu            | Ürün Adı                  | İç Çap | Dış Çap | Amb. Birimi | Koli Adedi | Fiyat (₺) |
|----------------------|---------------------------|--------|---------|-------------|------------|-----------|
| 001 020 500001 05 XX | NO.1 PANO SİRİRALİ (50cm) | 5      | 6       | 100 ad.     | 4.000      | 6,27      |
| 001 020 500002 05 XX | NO.2 PANO SİRİRALİ (50cm) | 7      | 8       | 100 ad.     | 3.000      | 8,33      |
| 001 020 500003 05 XX | NO.3 PANO SİRİRALİ (50cm) | 10     | 11      | 100 ad.     | 2.000      | 9,77      |
| 001 020 500004 05 XX | NO.4 PANO SİRİRALİ (50cm) | 13     | 14      | 50 ad.      | 800        | 17,84     |
| 001 020 500005 05 XX | NO.5 PANO SİRİRALİ (50cm) | 16     | 17      | 25 ad.      | 800        | 18,28     |

## HELEZON PANO SİRİRALİ (RULO)

XX yerine 00 Şeffaf / XX yerine 11 Siyah

| Ürün Kodu            | Ürün Adı                   | İç Çap | Dış Çap | Amb. Birimi | Koli Adedi | Fiyat (₺) |
|----------------------|----------------------------|--------|---------|-------------|------------|-----------|
| 001 020 600001 00 XX | NO.1 PANO SİRİRALİ (100cm) | 5      | 6       | 100 ad.     | 4.000      | 12,68     |
| 001 020 600002 00 XX | NO.2 PANO SİRİRALİ (100cm) | 7      | 8       | 100 ad.     | 3.000      | 15,55     |
| 001 020 600003 00 XX | NO.3 PANO SİRİRALİ (100cm) | 10     | 11      | 100 ad.     | 2.000      | 18,47     |
| 001 020 600004 00 XX | NO.4 PANO SİRİRALİ (100cm) | 13     | 14      | 50 ad.      | 800        | 35,16     |
| 001 020 600005 00 XX | NO.5 PANO SİRİRALİ (100cm) | 16     | 17      | 25 ad.      | 800        | 36,00     |

# R-MEKS SERİSİ

X yerine Gri için 7, Siyah için 1 rakamını yazınız. IP68



750°C  
Alev Yaymazlık

| Ürün Kodu                             | Ürün Adı       | Kablo Sıkma Çapı     | Kutu Adet | Koli Adet | Fiyat (₺) |        |
|---------------------------------------|----------------|----------------------|-----------|-----------|-----------|--------|
| <b>R-MEKS PG PLASTİK KABLO RAKORU</b> |                |                      |           |           |           |        |
| 010 097 1X0007                        | R-MEKS PG-7    | PLASTİK KABLO RAKORU | 3-6,5 mm  | 450       | 4.500     | 10,90  |
| 010 097 1X0009                        | R-MEKS PG-9    | PLASTİK KABLO RAKORU | 4-6 mm    | 300       | 3.000     | 12,76  |
| 010 097 1X0011                        | R-MEKS PG-11   | PLASTİK KABLO RAKORU | 5-10 mm   | 200       | 2.000     | 15,81  |
| 010 097 1X0135                        | R-MEKS PG-13,5 | PLASTİK KABLO RAKORU | 6-12 mm   | 175       | 1750      | 17,23  |
| 010 097 1X0016                        | R-MEKS PG-16   | PLASTİK KABLO RAKORU | 10-14 mm  | 125       | 1250      | 21,37  |
| 010 097 1X0021                        | R-MEKS PG-21   | PLASTİK KABLO RAKORU | 13-18 mm  | 75        | 750       | 33,80  |
| 010 097 1X0029                        | R-MEKS PG-29   | PLASTİK KABLO RAKORU | 18-25 mm  | 40        | 400       | 61,61  |
| 010 097 1X0036                        | R-MEKS PG-36   | PLASTİK KABLO RAKORU | 22-32 mm  | 20        | 200       | 105,11 |
| 010 097 1X0042                        | R-MEKS PG-42   | PLASTİK KABLO RAKORU | 32-38 mm  | 15        | 150       | 129,32 |
| 010 097 1X0048                        | R-MEKS PG-48   | PLASTİK KABLO RAKORU | 37-44 mm  | 12        | 120       | 145,67 |



X yerine Gri için 7, Siyah için 1 rakamını yazınız. IP68

| Ürün Kodu                                 | Ürün Adı   | Kablo Sıkma Çapı | Kutu Adet | Koli Adet | Fiyat (₺) |
|---|--|------------------|-----------|-----------|-----------|
| <b>R-MEKS METRİK PLASTİK KABLO RAKORU</b> |  |                  |           |           |           |
| 010 097 1X0712                            | R-MEKS M12X1,5 METRİK PLASTİK KABLO RAKORU (PG 7)    | 3-6,5 mm         | 450       | 4500      | 11,22     |
| 010 097 1X1112                            | R-MEKS M16X1,5 METRİK PLASTİK KABLO RAKORU (PG 11)   | 5-10 mm          | 200       | 2000      | 15,99     |
| 010 097 1X1320                            | R-MEKS M20X1,5 METRİK PLASTİK KABLO RAKORU (PG 13,5) | 6-12 mm          | 175       | 1750      | 18,40     |
| 010 097 1X1620                            | R-MEKS M20X1,5 METRİK PLASTİK KABLO RAKORU (PG 16)   | 10-14 mm         | 125       | 1250      | 21,89     |
| 010 097 1X2125                            | R-MEKS M25X1,5 METRİK PLASTİK KABLO RAKORU (PG 21)   | 13-18 mm         | 75        | 750       | 34,73     |
| 010 097 1X2932                            | R-MEKS M32X1,5 METRİK PLASTİK KABLO RAKORU (PG 29)   | 18-25 mm         | 40        | 400       | 73,01     |
| 010 097 1X3640                            | R-MEKS M40X1,5 METRİK PLASTİK KABLO RAKORU (PG 36)   | 22-32 mm         | 20        | 200       | 118,71    |
| 010 097 1X4250                            | R-MEKS M50X1,5 METRİK PLASTİK KABLO RAKORU (PG 42)   | 32-38 mm         | 15        | 150       | 152,30    |
| 010 097 1X4863                            | R-MEKS M63X1,5 METRİK PLASTİK KABLO RAKORU (PG 48)   | 37-44 mm         | 12        | 120       | 184,26    |



# R-MEKS SERİSİ



Bağlantılarınızı Güçlendirin

**PG**

**METRİK**

Her İhtiyaca Yönelik Kablo Rakorları

# Promex Rakor

## PLASTİK KABLO RAKORU

X yerine 0 Açık Gri / X yerine 1 Siyah / X yerine 3 Gri IP68



| Ürün Kodu                                | Ürün Adı                  | Kablo Sıkma Çapı | Delik Çapı | Kutu Adet | Koli Adet | Fiyat (€) |
|--|---------------------------|------------------|------------|-----------|-----------|-----------|
| <b>PROMEX SMART PLASTİK KABLO RAKORU</b> |                           |                  |            |           |           |           |
| 057 097 411X16                           | 16'LİK SMART KABLO RAKORU | 5-10 mm          | 16 mm      | 150       | 1350      | 0,94 €    |
| 057 097 412X20                           | 20'LİK SMART KABLO RAKORU | 6-12 mm          | 20 mm      | 120       | 1080      | 0,99 €    |
| 057 097 422X25                           | 25'LİK SMART KABLO RAKORU | 11-17 mm         | 25 mm      | 50        | 450       | 1,43 €    |
| 057 097 422X32                           | 32'LİK SMART KABLO RAKORU | 15-21 mm         | 32 mm      | 40        | 360       | 2,41 €    |
| 057 097 422X40                           | 40'LİK SMART KABLO RAKORU | 19-28 mm         | 40 mm      | 20        | 180       | 4,03 €    |

\* Smart rakorların çikartma somunları harici olarak satılmaktadır.

X yerine 0 Açık Gri / X yerine 1 Siyah / X yerine 3 Gri

IP68



| Ürün Kodu                             | Ürün Adı                     | Kablo Sıkma Çapı | Delik Çapı | Kutu Adet | Koli Adet | Fiyat (€) |
|---------------------------------------|------------------------------|------------------|------------|-----------|-----------|-----------|
| <b>PROMEX PG PLASTİK KABLO RAKORU</b> |                              |                  |            |           |           |           |
| 057 097 211X07                        | PG 7 PLASTİK KABLO RAKORU    | 3-6,5 mm         | 13         | 450       | 4050      | 0,30 €    |
| 057 097 212X09                        | PG 9 PLASTİK KABLO RAKORU    | 4-8 mm           | 15,5       | 300       | 2700      | 0,32 €    |
| 057 097 213X11                        | PG 11 PLASTİK KABLO RAKORU   | 5-10 mm          | 19         | 200       | 1800      | 0,37 €    |
| 057 097 214X14                        | PG 13,5 PLASTİK KABLO RAKORU | 6-12 mm          | 20,5       | 175       | 1575      | 0,43 €    |
| 057 097 215X16                        | PG 16 PLASTİK KABLO RAKORU   | 10-14 mm         | 22,5       | 125       | 1125      | 0,49 €    |
| 057 097 216X21                        | PG 21 PLASTİK KABLO RAKORU   | 13-18 mm         | 28,5       | 75        | 675       | 0,78 €    |
| 057 097 217X29                        | PG 29 PLASTİK KABLO RAKORU   | 18-25 mm         | 37,5       | 40        | 360       | 1,42 €    |
| 057 097 218X36                        | PG 36 PLASTİK KABLO RAKORU   | 22-32 mm         | 47,5       | 20        | 180       | 2,41 €    |
| 057 097 219X42                        | PG 42 PLASTİK KABLO RAKORU   | 30-38 mm         | 54,5       | 15        | 135       | 2,96 €    |
| 057 097 220X48                        | PG 48 PLASTİK KABLO RAKORU   | 34-44 mm         | 60,5       | 12        | 108       | 3,34 €    |

X yerine 0 Açık Gri / X yerine 1 Siyah / X yerine 3 Gri

IP68



| Ürün Kodu                                 | Ürün Adı                     | Kablo Sıkma Çapı | Delik Çapı (Diş Çekilmiş) | Delik Çapı (Diş Çekme) | Kutu Adedi | Koli Adedi | Fiyat (€) |
|---|------------------------------|------------------|---------------------------|------------------------|------------|------------|-----------|
| <b>PROMEX METRİK PLASTİK KABLO RAKORU</b> |                              |                  |                           |                        |            |            |           |
| 057 097 310X12                            | M12x1,5 METRİK PLASTİK RAKOR | 3-6,5 mm         | 12 mm                     | 10,5 mm                | 450        | 4050       | 0,39 €    |
| 057 097 311X16                            | M16x1,5 METRİK PLASTİK RAKOR | 5-10 mm          | 16 mm                     | 14,5 mm                | 200        | 1800       | 0,38 €    |
| 057 097 312X20                            | M20x1,5 METRİK PLASTİK RAKOR | 6-12 mm          | 20 mm                     | 18,5 mm                | 175        | 1575       | 0,43 €    |
| 057 097 313X20                            | M20x1,5 METRİK PLASTİK RAKOR | 10-14 mm         | 20 mm                     | 18,5 mm                | 125        | 1125       | 0,54 €    |
| 057 097 314X20                            | M20x1,5 METRİK PLASTİK RAKOR | 10-14 mm         | 20 mm                     | 18,5 mm                | 125        | 1125       | 0,54 €    |
| 057 097 315X25                            | M25x1,5 METRİK PLASTİK RAKOR | 13-18 mm         | 25 mm                     | 23,5 mm                | 75         | 675        | 0,79 €    |
| 057 097 316X25                            | M25x1,5 METRİK PLASTİK RAKOR | 13-18 mm         | 25 mm                     | 23,5 mm                | 75         | 675        | 0,84 €    |
| 057 097 317X32                            | M32x1,5 METRİK PLASTİK RAKOR | 18-25 mm         | 32 mm                     | 30,5 mm                | 40         | 360        | 1,67 €    |
| 057 097 318X40                            | M40x1,5 METRİK PLASTİK RAKOR | 22-32 mm         | 40 mm                     | 38,5 mm                | 20         | 180        | 2,65 €    |
| 057 097 319X50                            | M50x1,5 METRİK PLASTİK RAKOR | 30-38 mm         | 50 mm                     | 48,5 mm                | 15         | 135        | 3,49 €    |
| 057 097 320X63                            | M63x1,5 METRİK PLASTİK RAKOR | 34-44 mm         | 63 mm                     | 61,5 mm                | 12         | 108        | 3,99 €    |

| Ürün Kodu                                 | Ürün Adı                              | Kablo Sıkma Çapı | Diş Boyu | Kutu Adet | Koli Adet | Fiyat (€) |
|---|---------------------------------------|------------------|----------|-----------|-----------|-----------|
| <b>PROMEX PLASTİK SİRAL RAKORLAR(GRİ)</b> |                                       |                  |          |           |           |           |
| 057 097 601007                            | PROMEX PG-7 SİRAL UÇLU RAKOR (GRİ)    | 3,00-6,50        | 8 mm     | 100       | 2500      | 1,03 €    |
| 057 097 602009                            | PROMEX PG-9 SİRAL UÇLU RAKOR (GRİ)    | 4,00-8,00        | 8 mm     | 50        | 1500      | 1,24 €    |
| 057 097 603011                            | PROMEX PG-11 SİRAL UÇLU RAKOR(GRİ)    | 5,00-10,00       | 8 mm     | 50        | 1500      | 1,38 €    |
| 057 097 604014                            | PROMEX PG-13,5 SİRAL UÇLU RAKOR (GRİ) | 6,00-12,00       | 10 mm    | 50        | 1000      | 1,59 €    |
| 057 097 605016                            | PROMEX PG-16 SİRAL UÇLU RAKOR(GRİ)    | 10,00-14,00      | 10 mm    | 50        | 500       | 1,63 €    |
| 057 097 606021                            | PROMEX PG-21 SİRAL UÇLU RAKOR(GRİ)    | 13,00-18,00      | 11 mm    | 25        | 250       | 2,34 €    |



“Her Bağlantıda; KALİTE”

# POLYAMİD SİRAL RAKORLARI



| Ürün Kodu                    | Ürün Adı                          | Kutu Adet  | Fiyat (€) |
|------------------------------|-----------------------------------|--|-----------|
| <b>POLYAMİD SİRAL RAKORU</b> |                                   | <b>X yerine Gri için 7, Siyah için 1 rakamını yazınız.</b> |           |
| 057 097 1X0007               | PSR-7 SİRAL RAKORU (GRİ-SİYAH)    | 50   | 0,57 €    |
| 057 097 1X0009               | PSR-9 SİRAL RAKORU (GRİ-SİYAH)    | 50   | 0,57 €    |
| 057 097 1X0011               | PSR-11 SİRAL RAKORU (GRİ-SİYAH)   | 50   | 0,60 €    |
| 057 097 1X0135               | PSR-13,5 SİRAL RAKORU (GRİ-SİYAH) | 50   | 0,69 €    |
| 057 097 1X0016               | PSR-16 SİRAL RAKORU (GRİ-SİYAH)   | 50   | 0,74 €    |
| 057 097 1X0021               | PSR-21 SİRAL RAKORU (GRİ-SİYAH)   | 25   | 1,03 €    |
| 057 097 1X0029               | PSR-29 SİRAL RAKORU (GRİ-SİYAH)   | 20   | 1,71 €    |
| 057 097 1X0036               | PSR-36 SİRAL RAKORU (GRİ-SİYAH)   | 10   | 2,40 €    |
| 057 097 1X0048               | PSR-48 SİRAL RAKORU (GRİ-SİYAH)   | 10   | 3,29 €    |



## METRİK POLYAMİD SİRAL RAKORU

|                |  |    |        |
|----------------|--|----|--------|
| 057 097 111012 | M12X1.5 (PSR-7) POLYAMİD SİRAL RAKORU (SİYAH)    | 50 | 0,57 € |
| 057 097 111016 | M16X1.5 (PSR-9) POLYAMİD SİRAL RAKORU (SİYAH)    | 50 | 0,57 € |
| 057 097 111018 | M18X1.5 (PSR-11) POLYAMİD SİRAL RAKORU (SİYAH)   | 50 | 0,60 € |
| 057 097 111020 | M20X1.5 (PSR-13,5) POLYAMİD SİRAL RAKORU (SİYAH) | 50 | 0,69 € |
| 057 097 111025 | M25X1.5 (PSR-16) POLYAMİD SİRAL RAKORU (SİYAH)   | 50 | 0,74 € |
| 057 097 111125 | M25X1.5 (PSR-21) POLYAMİD SİRAL RAKORU (SİYAH)   | 25 | 1,03 € |
| 057 097 111032 | M32X1.5 (PSR-29) POLYAMİD SİRAL RAKORU (SİYAH)   | 20 | 1,71 € |
| 057 097 111040 | M40X1.5 (PSR-36) POLYAMİD SİRAL RAKORU (SİYAH)   | 10 | 2,40 € |
| 057 097 111050 | M50X1.5 (PSR-48) POLYAMİD SİRAL RAKORU (SİYAH)   | 10 | 3,29 € |



## POLYAMİD SİRAL DİRSEĞİ

|                               |   |  |        |
|-------------------------------|---|--|--------|
| <b>POLYAMİD SİRAL DİRSEĞİ</b> |   | <b>X yerine Gri için 7, Siyah için 0 rakamını yazınız.</b> |        |
| 057 097 12X007                | PSRD-7 SİRAL RAKORU 90° DİRSEK (GRİ-SİYAH)    | 50   | 1,20 € |
| 057 097 12X009                | PSRD-9 SİRAL RAKORU 90° DİRSEK (GRİ-SİYAH)    | 50   | 1,28 € |
| 057 097 12X011                | PSRD-11 SİRAL RAKORU 90° DİRSEK (GRİ-SİYAH)   | 50   | 1,41 € |
| 057 097 12X135                | PSRD-13,5 SİRAL RAKORU 90° DİRSEK (GRİ-SİYAH) | 50   | 1,67 € |
| 057 097 12X016                | PSRD-16 SİRAL RAKORU 90° DİRSEK (GRİ-SİYAH)   | 50   | 1,93 € |
| 057 097 12X021                | PSRD-21 SİRAL RAKORU 90° DİRSEK (GRİ-SİYAH)   | 25   | 3,08 € |



## POLYAMİD SİRAL KROŞELERİ

|                                 |  |  |        |
|---------------------------------|--|--|--------|
| <b>POLYAMİD SİRAL KROŞELERİ</b> |  | <b>€ X yerine Gri için 7, Siyah için 0 rakamını yazınız.</b> |        |
| 057 097 16X007                  | PG-7 POLYAMİD SİRAL KROŞESİ (GRİ-SİYAH)    | 50   | 0,70 € |
| 057 097 16X009                  | PG-9 POLYAMİD SİRAL KROŞESİ (GRİ-SİYAH)    | 50   | 0,80 € |
| 057 097 16X011                  | PG-11 POLYAMİD SİRAL KROŞESİ (GRİ-SİYAH)   | 50   | 0,90 € |
| 057 097 16X135                  | PG-13,5 POLYAMİD SİRAL KROŞESİ (GRİ-SİYAH) | 50   | 1,00 € |
| 057 097 16X016                  | PG-16 POLYAMİD SİRAL KROŞESİ (GRİ-SİYAH)   | 50   | 1,10 € |
| 057 097 16X021                  | PG-21 POLYAMİD SİRAL KROŞESİ (GRİ-SİYAH)   | 25   | 1,25 € |
| 057 097 16X029                  | PG-29 POLYAMİD SİRAL KROŞESİ (GRİ-SİYAH)   | 25   | 1,52 € |
| 057 097 16X036                  | PG-36 POLYAMİD SİRAL KROŞESİ (GRİ-SİYAH)   | 25   | 2,33 € |
| 057 097 16X048                  | PG-48 POLYAMİD SİRAL KROŞESİ (GRİ-SİYAH)   | 10   | 3,24 € |



XX yerine Gri için 17, Siyah için 11 rakamını yazınız.

| Ürün Kodu | Ürün Adı | Kutu Adet | Koli Adet | Fiyat (₺) |
|-----------|----------|-----------|-----------|-----------|
|-----------|----------|-----------|-----------|-----------|

### SUNFLEX POLYAMİD SİRAL BORU (UV DAYANIMLI)

Rakor Ölçüsü Ort. İç Çap Ort. Dış Çap

|                      |   |         |       |       |         |      |        |
|----------------------|---|---------|-------|-------|---------|------|--------|
| 001 020 180007 00 XX | Ø7 POLYAMİD SİRAL BORU (UV DAYANIMLI)   | PSR7    | 7     | 10,1  | 100 mt. | 1000 | 27,00  |
| 001 020 180009 00 XX | Ø8,5 POLYAMİD SİRAL BORU (UV DAYANIMLI) |         | 8,4   | 12,05 | 100 mt. | 1000 | 29,15  |
| 001 020 180010 00 XX | Ø10 POLYAMİD SİRAL BORU (UV DAYANIMLI)  | PSR9    | 10,2  | 13,1  | 100 mt. | 1000 | 31,29  |
| 001 020 180012 00 XX | Ø12 POLYAMİD SİRAL BORU (UV DAYANIMLI)  | PSR11   | 12,3  | 15,9  | 50 mt.  | 500  | 50,71  |
| 001 020 180014 00 XX | Ø14 POLYAMİD SİRAL BORU (UV DAYANIMLI)  | PSR13,5 | 14,1  | 18,35 | 50 mt.  | 250  | 60,37  |
| 001 020 180017 00 XX | Ø17 POLYAMİD SİRAL BORU (UV DAYANIMLI)  | PSR16   | 17    | 21,45 | 50 mt.  | 250  | 71,67  |
| 001 020 180019 00 XX | Ø19 POLYAMİD SİRAL BORU (UV DAYANIMLI)  |         | 19    | 24,25 | 50 mt.  | 250  | 83,47  |
| 001 020 180023 00 XX | Ø23 POLYAMİD SİRAL BORU (UV DAYANIMLI)  | PSR21   | 23,25 | 28,5  | 50 mt.  | 250  | 94,70  |
| 001 020 180026 00 XX | Ø26 POLYAMİD SİRAL BORU (UV DAYANIMLI)  |         | 26,2  | 31,3  | 25 mt.  | 125  | 108,61 |
| 001 020 180029 00 XX | Ø29 POLYAMİD SİRAL BORU (UV DAYANIMLI)  | PSR29   | 29,1  | 34,3  | 25 mt.  | 125  | 123,21 |
| 001 020 180036 00 XX | Ø36 POLYAMİD SİRAL BORU (UV DAYANIMLI)  | PSR36   | 36,2  | 42,2  | 25 mt.  | 125  | 162,91 |
| 001 020 180048 00 XX | Ø48 POLYAMİD SİRAL BORU (UV DAYANIMLI)  | PSR48   | 48,5  | 54,5  | 25 mt.  | 125  | 228,93 |

### PA6 POLYAMİD SİRALER (ALEV YAYMAYAN)

|                      |                             |         |       |       |         |      |        |
|----------------------|-----------------------------|---------|-------|-------|---------|------|--------|
| 001 020 170007 00 XX | MUT/PA6-7 (ALEV YAYMAYAN)   | PSR7    | 7     | 10,1  | 100 mt. | 1000 | 20,51  |
| 001 020 170009 00 XX | MUT/PA6-8,5 (ALEV YAYMAYAN) |         | 8,4   | 12,05 | 100 mt. | 1000 | 22,00  |
| 001 020 170010 00 XX | MUT/PA6-10 (ALEV YAYMAYAN)  | PSR9    | 10,2  | 13,1  | 100 mt. | 1000 | 23,50  |
| 001 020 170012 00 XX | MUT/PA6-12 (ALEV YAYMAYAN)  | PSR11   | 12,3  | 15,9  | 50 mt.  | 500  | 38,08  |
| 001 020 170014 00 XX | MUT/PA6-14 (ALEV YAYMAYAN)  | PSR13,5 | 14,1  | 18,35 | 50 mt.  | 250  | 44,17  |
| 001 020 170017 00 XX | MUT/PA6-17 (ALEV YAYMAYAN)  | PSR16   | 17    | 21,45 | 50 mt.  | 250  | 53,14  |
| 001 020 170019 00 XX | MUT/PA6-19 (ALEV YAYMAYAN)  |         | 19    | 24,25 | 50 mt.  | 250  | 61,95  |
| 001 020 170023 00 XX | MUT/PA6-23 (ALEV YAYMAYAN)  | PSR21   | 23,25 | 28,5  | 50 mt.  | 250  | 69,88  |
| 001 020 170026 00 XX | MUT/PA6-26 (ALEV YAYMAYAN)  |         | 26,2  | 31,3  | 25 mt.  | 125  | 80,54  |
| 001 020 170029 00 XX | MUT/PA6-29 (ALEV YAYMAYAN)  | PSR29   | 29,1  | 34,3  | 25 mt.  | 125  | 91,52  |
| 001 020 170036 00 XX | MUT/PA6-36 (ALEV YAYMAYAN)  | PSR36   | 36,2  | 42,2  | 25 mt.  | 125  | 120,21 |
| 001 020 170048 00 XX | MUT/PA6-48 (ALEV YAYMAYAN)  | PSR48   | 48,5  | 54,5  | 25 mt.  | 125  | 166,68 |

### POLİPROPİLEN SİRAL BORU

|                      |                          |         |       |       |         |      |       |
|----------------------|--------------------------|---------|-------|-------|---------|------|-------|
| 001 020 160007 00 XX | MUT/PP-7 PP SİRAL BORU   | PSR7    | 7     | 10,1  | 100 mt. | 1000 | 12,16 |
| 001 020 160009 00 XX | MUT/PP-8,5 PP SİRAL BORU |         | 8,4   | 12,05 | 100 mt. | 1000 | 12,92 |
| 001 020 160010 00 XX | MUT/PP-10 PP SİRAL BORU  | PSR9    | 10,2  | 13,1  | 100 mt. | 1000 | 13,68 |
| 001 020 160012 00 XX | MUT/PP-12 PP SİRAL BORU  | PSR11   | 12,3  | 15,9  | 50 mt.  | 500  | 21,84 |
| 001 020 160014 00 XX | MUT/PP-14 PP SİRAL BORU  | PSR13,5 | 14,1  | 18,35 | 50 mt.  | 250  | 25,61 |
| 001 020 160017 00 XX | MUT/PP-17 PP SİRAL BORU  | PSR16   | 17    | 21,45 | 50 mt.  | 250  | 29,85 |
| 001 020 160019 00 XX | MUT/PP-19 PP SİRAL BORU  |         | 19    | 24,25 | 50 mt.  | 250  | 32,82 |
| 001 020 160023 00 XX | MUT/PP-23 PP SİRAL BORU  | PSR21   | 23,25 | 28,5  | 50 mt.  | 250  | 36,02 |
| 001 020 160026 00 XX | MUT/PP-26 PP SİRAL BORU  |         | 26,2  | 31,3  | 25 mt.  | 125  | 44,70 |
| 001 020 160029 00 XX | MUT/PP-29 PP SİRAL BORU  | PSR29   | 29,1  | 34,3  | 25 mt.  | 125  | 49,10 |
| 001 020 160036 00 XX | MUT/PP-36 PP SİRAL BORU  | PSR36   | 35,8  | 42,2  | 25 mt.  | 125  | 66,10 |
| 001 020 160048 00 XX | MUT/PP-48 PP SİRAL BORU  | PSR48   | 48,5  | 54,5  | 25 mt.  | 125  | 92,44 |

### POLYAMİD YARIKLI SİRAL BORU (ALEV YAYMAYAN)

|                      |  |  |  |  |         |      |        |
|----------------------|--|--|--|--|---------|------|--------|
| 001 020 470007 00 XX | Ø7 POLYAMİD YARIKLI SİRAL BORU (ALEV YAYMAYAN)   |  |  |  | 100 mt. | 1000 | 21,94  |
| 001 020 470009 00 XX | Ø8,5 POLYAMİD YARIKLI SİRAL BORU (ALEV YAYMAYAN) |  |  |  | 100 mt. | 1000 | 23,54  |
| 001 020 470010 00 XX | Ø10 POLYAMİD YARIKLI SİRAL BORU (ALEV YAYMAYAN)  |  |  |  | 100 mt. | 1000 | 25,15  |
| 001 020 470012 00 XX | Ø12 POLYAMİD YARIKLI SİRAL BORU (ALEV YAYMAYAN)  |  |  |  | 100 mt. | 500  | 40,74  |
| 001 020 470014 00 XX | Ø14 POLYAMİD YARIKLI SİRAL BORU (ALEV YAYMAYAN)  |  |  |  | 50 mt.  | 250  | 47,27  |
| 001 020 470017 00 XX | Ø17 POLYAMİD YARIKLI SİRAL BORU (ALEV YAYMAYAN)  |  |  |  | 50 mt.  | 250  | 56,86  |
| 001 020 470019 00 XX | Ø19 POLYAMİD YARIKLI SİRAL BORU (ALEV YAYMAYAN)  |  |  |  | 50 mt.  | 250  | 66,29  |
| 001 020 470023 00 XX | Ø23 POLYAMİD YARIKLI SİRAL BORU (ALEV YAYMAYAN)  |  |  |  | 50 mt.  | 250  | 74,77  |
| 001 020 470026 00 XX | Ø26 POLYAMİD YARIKLI SİRAL BORU (ALEV YAYMAYAN)  |  |  |  | 25 mt.  | 125  | 86,18  |
| 001 020 470029 00 XX | Ø29 POLYAMİD YARIKLI SİRAL BORU (ALEV YAYMAYAN)  |  |  |  | 25 mt.  | 125  | 97,93  |
| 001 020 470036 00 XX | Ø36 POLYAMİD YARIKLI SİRAL BORU (ALEV YAYMAYAN)  |  |  |  | 25 mt.  | 125  | 128,63 |
| 001 020 470048 00 XX | Ø48 POLYAMİD YARIKLI SİRAL BORU (ALEV YAYMAYAN)  |  |  |  | 25 mt.  | 125  | 178,35 |



## İZOLELİ KABLO YÜKSÜKLERİ - TEK GİRİŞ FRANSIZ - ALMAN NORMLARI

Standart : DIN 46228  
Malzeme : Bakır  
İzolasyon : Nylon  
Voltaj : <600V  
Çalışma Sıcaklığı : Max. 105°

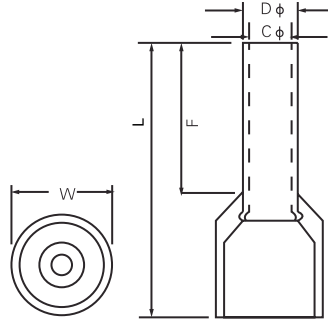

X= 0 Fransız X= F Fransız  
X= 2 Alman X= A Alman

| Ürün Kodu      | Model Kodu | Ebatlar |      |      |      |      | Kablo Kesiti | Renk       |            | Kutu Adet | Fiyat Adet (₺) |
|----------------|------------|---------|------|------|------|------|--------------|------------|------------|-----------|----------------|
|                |            | F       | L    | W    | DØ   | CØ   |              | Fransız    | Alman      |           |                |
| 014 100 X10258 | ITYX-0258  | 8.0     | 12.5 | 2.5  | 1.0  | 0.7  | 0.25         | Menekşe    | Mavi       | 1.000     | 1,26           |
| 014 100 X10348 | ITYX-0348  | 8.0     | 12.5 | 2.5  | 1.1  | 0.8  | 0.34         | Pembe      | Turkuaz    | 1.000     | 1,26           |
| 014 100 X10508 | ITYX-0508  | 8.0     | 14.0 | 2.6  | 1.3  | 1.0  | 0.50         | Beyaz      | Turuncu    | 1.000     | 0,58           |
| 014 100 X17508 | ITYX-7508  | 8.0     | 14.6 | 2.8  | 1.6  | 1.3  | 0.75         | Mavi       | Beyaz      | 1.000     | 0,58           |
| 014 100 X11008 | ITYX-1008  | 8.0     | 14.6 | 3.0  | 1.8  | 1.5  | 1.0          | Kırmızı    | Sarı       | 1.000     | 0,58           |
| 014 100 X11508 | ITYX-1508  | 8.0     | 16.4 | 3.5  | 2.1  | 1.8  | 1.5          | Siyah      | Kırmızı    | 1.000     | 0,64           |
| 014 100 X12508 | ITYX-2508  | 8.0     | 15.2 | 4.0  | 2.6  | 2.3  | 2.5          | Gri        | Mavi       | 500       | 0,82           |
| 014 100 X14009 | ITYX-4009  | 9.0     | 16.5 | 4.4  | 3.2  | 2.8  | 4.0          | Turuncu    | Gri        | 500       | 1,37           |
| 014 100 X16012 | ITYX-6012  | 12.0    | 20.0 | 6.3  | 3.9  | 3.5  | 6.0          | Yeşil      | Siyah      | 250       | 1,89           |
| 014 100 X11012 | ITYX-1012  | 12.0    | 21.5 | 7.6  | 4.9  | 4.5  | 10.0         | Kahverengi | Bej        | 100       | 2,36           |
| 014 100 X11612 | ITYX-1612  | 12.0    | 22.2 | 8.8  | 6.2  | 5.8  | 16.0         | Bej        | Yeşil      | 100       | 3,26           |
| 014 100 X12516 | ITYX-2516  | 16.0    | 29.0 | 11.2 | 7.9  | 7.5  | 25.0         | Siyah      | Kahverengi | 50        | 5,46           |
| 014 100 X13516 | ITYX-3516  | 16.0    | 30.0 | 12.7 | 8.7  | 8.3  | 35.0         | Kırmızı    | Bej        | 25        | 6,83           |
| 014 100 X15020 | ITYX-5020  | 20.0    | 36.0 | 15.3 | 10.9 | 10.3 | 50.0         | Mavi       | Yeşil      | 25        | 12,60          |
| 014 100 017020 | ITYF-7020  | 20.0    | 37.0 | 16.0 | 14.3 | 13.5 | 70.0         | Sarı       | -          | 25        | 23,10          |

## İZOLELİ KABLO YÜKSÜKLERİ - ÇİFT GİRİŞ FRANSIZ - ALMAN NORMLARI

Standart : DIN 46228  
Malzeme : Bakır  
İzolasyon : Nylon  
Voltaj : <600V  
Çalışma Sıcaklığı : Max. 105°

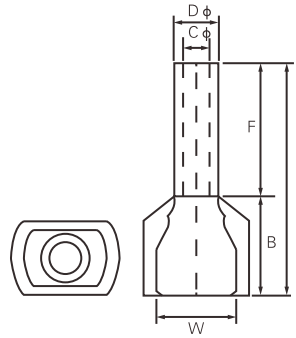

X= 0 Fransız X= F Fransız  
X= 2 Alman X= A Alman

| Ürün Kodu      | Model Kodu | Ebatlar |      |      |      |     |     | Kablo Kesiti | Renk       |         | Kutu Adet | Fiyat Adet (₺) |
|----------------|------------|---------|------|------|------|-----|-----|--------------|------------|---------|-----------|----------------|
|                |            | F       | L    | W    | B    | DØ  | CØ  |              | Fransız    | Alman   |           |                |
| 014 100 X20508 | ICYX-0508  | 8.0     | 14.5 | 5.0  | 6.5  | 1.8 | 1.5 | 2x0.5        | Beyaz      | Turuncu | 1.000     | 1,03           |
| 014 100 X27508 | ICYX-7508  | 8.0     | 14.7 | 5.5  | 6.7  | 2.1 | 1.8 | 2x0.75       | Mavi       | Beyaz   | 500       | 1,10           |
| 014 100 X21008 | ICYX-1008  | 8.0     | 15.1 | 5.5  | 7.1  | 2.3 | 2.0 | 2x1.0        | Kırmızı    | Sarı    | 500       | 1,16           |
| 014 100 X21508 | ICYX-1508  | 8.0     | 15.5 | 6.4  | 7.2  | 2.6 | 2.3 | 2x1.5        | Siyah      | Kırmızı | 500       | 1,42           |
| 014 100 X22510 | ICYX-2510  | 10.0    | 18.5 | 8.0  | 8.5  | 3.3 | 2.9 | 2x2.5        | Gri        | Mavi    | 250       | 2,26           |
| 014 100 X24012 | ICYX-4012  | 12.0    | 23.1 | 8.8  | 11.1 | 4.2 | 3.8 | 2x4.0        | Turuncu    | Gri     | 200       | 2,63           |
| 014 100 X26014 | ICYX-6014  | 14.0    | 26.1 | 9.5  | 12.1 | 5.3 | 4.9 | 2x6.0        | Yeşil      | Siyah   | 100       | 3,26           |
| 014 100 X21014 | ICYX-1014  | 14.0    | 26.6 | 12.6 | 12.0 | 6.9 | 6.5 | 2x10.0       | Kahverengi | Bej     | 50        | 4,99           |
| 014 100 X21614 | ICYX-1614  | 14.0    | 31.3 | 19.0 | 17.3 | 8.7 | 8.3 | 2x16.0       | Bej        | Yeşil   | 50        | 6,30           |

## İZOLESİZ KABLO YÜKSÜKLERİ - TEK GİRİŞ

Standart : DIN 46228  
Malzeme : Bakır  
Voltaj : <600V  
Çalışma Sıcaklığı : Max. 105°

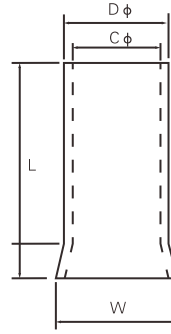

| Ürün Kodu      | Model Kodu | Ebatlar |      |      |      | Kablo Kesiti | Kutu Adet | Fiyat Adet (₺) |
|----------------|------------|---------|------|------|------|--------------|-----------|----------------|
|                |            | L       | W    | DØ   | CØ   |              |           |                |
| 014 100 120510 | KTY-0508   | 10.0    | 1.7  | 1.3  | 1.0  | 0.50         | 2.000     | 0,58           |
| 014 100 127510 | KTY-7508   | 10.0    | 1.9  | 1.6  | 1.3  | 0.75         | 1.000     | 0,58           |
| 014 100 121010 | KTY-1008   | 10.0    | 2.2  | 1.8  | 1.5  | 1.0          | 1.000     | 0,58           |
| 014 100 121510 | KTY-1508   | 10.0    | 2.5  | 2.1  | 1.8  | 1.5          | 1.000     | 0,64           |
| 014 100 122512 | KTY-2508   | 12.0    | 3.3  | 2.6  | 2.3  | 2.5          | 1.000     | 0,89           |
| 014 100 124012 | KTY-4009   | 12.0    | 3.9  | 3.2  | 2.8  | 4.0          | 1.000     | 1,21           |
| 014 100 126012 | KTY-6012   | 12.0    | 4.8  | 3.9  | 3.5  | 6.0          | 500       | 1,63           |
| 014 100 121015 | KTY-1012   | 15.0    | 5.8  | 4.9  | 4.5  | 10.0         | 250       | 2,73           |
| 014 100 121615 | KTY-1612   | 15.0    | 7.2  | 6.2  | 5.8  | 16.0         | 250       | 3,36           |
| 014 100 122516 | KTY-2516   | 16.0    | 9.1  | 7.9  | 7.5  | 25.0         | 100       | 5,06           |
| 014 100 123516 | KTY-3516   | 16.0    | 10.2 | 8.7  | 8.3  | 35.0         | 100       | 5,60           |
| 014 100 125020 | KTY-5020   | 20.0    | 12.4 | 10.9 | 10.3 | 50.0         | 50        | 11,43          |

## İZOLELİ YUVARLAK TİP PAPUÇ

Standart : DIN 46228  
Malzeme : Bakır  
İzolasyon : PVC  
Voltaj : <600V  
Çalışma Sıcaklığı : Max. 105°

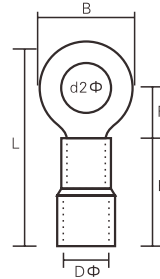

| Ürün Kodu      | Model Kodu | Civata Çapı (d2) mm | Ebatlar |      |      |      |     | Renk    | Kablo Kesiti                    | Kutu Adet | Fiyat Adet (₺) |
|----------------|------------|---------------------|---------|------|------|------|-----|---------|---------------------------------|-----------|----------------|
|                |            |                     | B       | F    | L    | E    | DØ  |         |                                 |           |                |
| 014 100 030153 | IYP-1,5-3  | 3.2                 | 5.7     | 4.95 | 17.8 | 10.0 | 4.3 | Kırmızı | 0.5 ~1.5 mm <sup>2</sup><br>19A | 200       | 1,89           |
| 014 100 030154 | IYP-1,5-4  | 4.3                 | 8.0     | 7.0  | 21.0 | 10.0 | 4.3 |         |                                 | 200       | 2,73           |
| 014 100 030155 | IYP-1,5-5  | 5.3                 | 9.5     | 8.5  | 22.2 | 10.0 | 4.3 |         |                                 | 200       | 2,78           |
| 014 100 030156 | IYP-1,5-6  | 6.5                 | 11.6    | 11.1 | 27.0 | 10.0 | 4.3 |         |                                 | 200       | 4,41           |
| 014 100 030158 | IYP-1,5-8  | 8.5                 | 11.6    | 11.1 | 27.0 | 10.0 | 4.3 |         |                                 | 200       | 4,41           |
| 014 100 030253 | IYP-2,5-3  | 3.2                 | 6.6     | 4.8  | 17.8 | 10.0 | 4.9 | Mavi    | 1.5 ~2.5 mm <sup>2</sup><br>27A | 200       | 3,36           |
| 014 100 030254 | IYP-2,5-4  | 4.3                 | 8.5     | 7.4  | 21.7 | 10.0 | 4.9 |         |                                 | 200       | 3,36           |
| 014 100 030255 | IYP-2,5-5  | 5.3                 | 9.5     | 7.4  | 22.5 | 10.0 | 4.9 |         |                                 | 200       | 3,47           |
| 014 100 030256 | IYP-2,5-6  | 6.5                 | 12.0    | 11.0 | 27.0 | 10.0 | 4.9 |         |                                 | 200       | 4,94           |
| 014 100 030258 | IYP-2,5-8  | 8.5                 | 12.0    | 11.0 | 27.0 | 10.0 | 4.9 |         |                                 | 200       | 4,94           |
| 014 100 032510 | IYP-2,5-10 | 10.5                | 13.6    | 13.9 | 30.7 | 10.0 | 4.9 | 200     | 5,04                            |           |                |
| 014 100 036004 | IYP-6-4    | 4.3                 | 9.5     | 8.3  | 26.0 | 13.0 | 6.7 | Sarı    | 4 ~6 mm <sup>2</sup><br>48A     | 100       | 7,14           |
| 014 100 036005 | IYP-6-5    | 5.3                 | 9.5     | 8.3  | 26.0 | 13.0 | 6.7 |         |                                 | 100       | 7,14           |
| 014 100 036006 | IYP-6-6    | 6.5                 | 12.0    | 10.5 | 29.5 | 13.0 | 6.7 |         |                                 | 100       | 8,09           |
| 014 100 036008 | IYP-6-8    | 8.5                 | 15.0    | 13.7 | 35.0 | 13.0 | 6.7 |         |                                 | 100       | 10,50          |
| 014 100 036010 | IYP-6-10   | 10.5                | 15.0    | 13.7 | 35.0 | 13.0 | 6.7 |         |                                 | 100       | 10,50          |
| 014 100 036012 | IYP-6-12   | 13.0                | 19.2    | 16.0 | 39.4 | 13.0 | 6.7 |         |                                 | 100       | 10,71          |

## ÇATAL TIP İZOLELİ KABLO UÇLARI



Standart : DIN 46228  
Malzeme : Bakır  
İzolasyon : PVC  
Voltaj : <600V  
Çalışma Sıcaklığı : Max. 105°

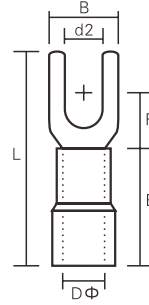

| Ürün Kodu      | Model Kodu | Civata Çapı (d2) mm | Ebatlar |      |      |      |     | Renk    | Kablo Kesiti                    | Kutu Adet | Fiyat Adet (₺) |
|----------------|------------|---------------------|---------|------|------|------|-----|---------|---------------------------------|-----------|----------------|
|                |            |                     | B       | F    | L    | H    | DØ  |         |                                 |           |                |
| 014 100 040153 | ICP-1,5-3  | 3.2                 | 5.7     | 6.5  | 21.2 | 10.0 | 4.3 | Kırmızı | 0.5 ~1.5 mm <sup>2</sup><br>19A | 200       | 2,52           |
| 014 100 040154 | ICP-1,5-4  | 4.3                 | 8.1     | 6.5  | 21.2 | 10.0 | 4.3 |         |                                 | 200       | 2,57           |
| 014 100 040155 | ICP-1,5-5  | 5.3                 | 9.5     | 6.5  | 21.2 | 10.0 | 4.3 |         |                                 | 200       | 2,68           |
| 014 100 040156 | ICP-1,5-6  | 6.5                 | 12.0    | 11.0 | 27.2 | 10.0 | 4.3 |         |                                 | 200       | 3,05           |
| 014 100 040253 | ICP-2,5-3  | 3.2                 | 5.7     | 6.5  | 21.2 | 10.0 | 4.9 | Mavi    | 1.5 ~2.5 mm <sup>2</sup><br>27A | 200       | 2,78           |
| 014 100 040254 | ICP-2,5-4  | 4.3                 | 8.1     | 6.5  | 21.2 | 10.0 | 4.9 |         |                                 | 200       | 2,89           |
| 014 100 040255 | ICP-2,5-5  | 5.3                 | 9.5     | 6.5  | 21.2 | 10.0 | 4.9 |         |                                 | 200       | 2,99           |
| 014 100 040256 | ICP-2,5-6  | 6.5                 | 12.0    | 11.0 | 27.2 | 10.0 | 4.9 |         |                                 | 200       | 3,89           |
| 014 100 046004 | ICP-6-4    | 4.3                 | 9.0     | 7.5  | 26.5 | 13.0 | 6.7 | Sarı    | 4 ~6 mm <sup>2</sup><br>48A     | 100       | 6,30           |
| 014 100 046005 | ICP-6-5    | 5.3                 | 9.0     | 7.5  | 26.5 | 13.0 | 6.7 |         |                                 | 100       | 6,30           |
| 014 100 046006 | ICP-6-6    | 6.5                 | 12.0    | 12.0 | 32.5 | 13.0 | 6.7 |         |                                 | 100       | 8,40           |
| 014 100 046008 | ICP-6-8    | 8.5                 | 14.0    | 11.5 | 31.5 | 13.0 | 6.7 |         |                                 | 100       | 9,98           |



## TAM İZOLELİ FASTON DİŞİ TERMİNAL

Malzeme : Pirinç  
İzolasyon : PVC  
Voltaj : <600V  
Çalışma Sıcaklığı : Max. 75°

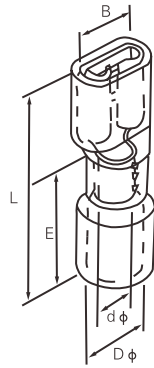

| Ürün Kodu      | Model Kodu      | Soket Ölçüsü | Kalınlık (mm) | Ebatlar |     |     |      |      | Renk    | Kablo Kesiti                    | Kutu Adet | Fiyat Adet (₺) |
|----------------|-----------------|--------------|---------------|---------|-----|-----|------|------|---------|---------------------------------|-----------|----------------|
|                |                 |              |               | B       | DØ  | dØ  | L    | E    |         |                                 |           |                |
| 014 100 090508 | TDT-0,5-1/2.8   | 0.5x2.8      | 0.30          | 3.3     | 3.8 | 1.7 | 20.0 | 10.0 | Kırmızı | 0.5 ~1.5 mm <sup>2</sup><br>10A | 200       | 2,78           |
| 014 100 090509 | TDT-0,5-1/4.8   | 0.8x4.75     | 0.35          | 5.0     | 3.8 | 1.7 | 20.5 | 10.0 |         |                                 | 200       | 3,26           |
| 014 100 090510 | TDT-0,5-1/6.4   | 0.8x6.35     | 0.40          | 6.6     | 3.8 | 1.7 | 22.4 | 10.0 |         |                                 | 200       | 3,89           |
| 014 100 091523 | TDT-1,5-2,5/2.8 | 0.8x2.8      | 0.30          | 3.3     | 4.3 | 2.3 | 20.0 | 10.0 | Mavi    | 1.5 ~2.5 mm <sup>2</sup><br>15A | 200       | 3,26           |
| 014 100 091524 | TDT-1,5-2,5/4.8 | 0.8x4.75     | 0.35          | 5.0     | 4.3 | 2.3 | 20.5 | 10.0 |         |                                 | 200       | 3,36           |
| 014 100 091525 | TDT-1,5-2,5/6.4 | 0.8x6.35     | 0.40          | 6.6     | 4.3 | 2.3 | 22.7 | 10.0 |         |                                 | 200       | 3,99           |
| 014 100 094060 | TDT-4-6         | 0.8x6.35     | 0.40          | 6.6     | 5.7 | 3.4 | 23.0 | 12.5 | Sarı    | 4 ~6 mm <sup>2</sup><br>24A     | 100       | 4,73           |

## TAM İZOLELİ DİŐİ TERMİNAL

Malzeme : Pirinç  
İzolasyon : PVC  
Voltaj : <600V  
Çalışma Sıcaklığı : Max.75°

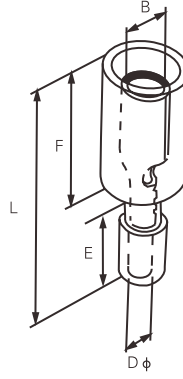

| Ürün Kodu      | Model Kodu  | Kalınlık mm | Ebatlar |     |     |      |      | Renk    | Kablo Kesiti                    | Kutu Adet | Fiyat Adet (₺) |
|----------------|-------------|-------------|---------|-----|-----|------|------|---------|---------------------------------|-----------|----------------|
|                |             |             | B       | F   | DØ  | E    | L    |         |                                 |           |                |
| 014 100 100510 | YDT-0,5-1   | 0.40        | 4.0     | 7.0 | 1.7 | 10.5 | 23.3 | Kırmızı | 0.5 ~1.5 mm <sup>2</sup><br>10A | 200       | 7,77           |
| 014 100 101525 | YDT-1,5-2,5 | 0.40        | 5.0     | 7.0 | 2.3 | 10.5 | 25.1 | Mavi    | 1.5 ~2.5 mm <sup>2</sup><br>15A | 100       | 8,82           |
| 014 100 104060 | YDT-4-6     | 0.40        | 5.0     | 7.0 | 3.4 | 12.5 | 25.1 | Sarı    | 4 ~6 mm <sup>2</sup><br>24A     | 100       | 10,92          |

## İZOLELİ EK MUF - UZUN TİP

Standart : DIN 46237  
Malzeme : Bakır / Copper  
İzolasyon : PVC  
Voltaj : <600V  
Çalışma Sıcaklığı : Max. 75°

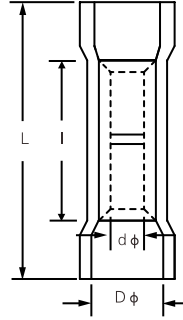

| Ürün Kodu      | Model Kodu | Maximum Akım | Ebatlar |     |     |      | Renk    | Kablo Kesiti             | Kutu Adet | Fiyat Adet (₺) |
|----------------|------------|--------------|---------|-----|-----|------|---------|--------------------------|-----------|----------------|
|                |            |              | l       | dØ  | DØ  | L    |         |                          |           |                |
| 014 100 070015 | IEM-1,5    | 19A          | 15.0    | 1.7 | 4.3 | 25.0 | Kırmızı | 0.5 ~1.5 mm <sup>2</sup> | 200       | 3,89           |
| 014 100 070025 | IEM-2,5    | 27A          | 15.0    | 2.3 | 4.9 | 25.0 | Mavi    | 1.5 ~2.5 mm <sup>2</sup> | 200       | 3,89           |
| 014 100 070040 | IEM-4      | 48A          | 15.0    | 3.4 | 6.7 | 25.0 | Sarı    | 4 ~6 mm <sup>2</sup>     | 100       | 6,56           |

## İZOLELİ İÇNE TİP TERMİNAL

Malzeme : Bakır  
İzolasyon : PVC  
Voltaj : <600V  
Çalışma Sıcaklığı : Max. 75°

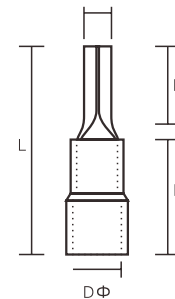

| Ürün Kodu      | Model Kodu | Kalınlık mm | Ebatlar |      |      |      |     | Renk    | Kablo Kesiti                    | Kutu Adet | Fiyat Adet (₺) |
|----------------|------------|-------------|---------|------|------|------|-----|---------|---------------------------------|-----------|----------------|
|                |            |             | B       | F    | L    | E    | DØ  |         |                                 |           |                |
| 014 100 050015 | IIT-1,5    | 0.7         | 1.9     | 10.0 | 20.0 | 10.0 | 4.3 | Kırmızı | 0.5 ~1.5 mm <sup>2</sup><br>19A | 200       | 2,94           |
| 014 100 050025 | IIT-2,5    | 0.8         | 1.9     | 12.0 | 22.0 | 10.0 | 4.9 | Mavi    | 1.5 ~2.5 mm <sup>2</sup><br>27A | 200       | 3,57           |
| 014 100 050040 | IIT-4      | 1.0         | 2.8     | 13.0 | 26.8 | 13.0 | 6.7 | Sarı    | 4 ~6 mm <sup>2</sup><br>48A     | 100       | 8,40           |

## İZOLELİ FASTON ERKEK TERMİNAL

Malzeme : Pirinç  
İzolasyon : PVC  
Voltaj : <600V  
Çalışma Sıcaklığı : Max. 75°

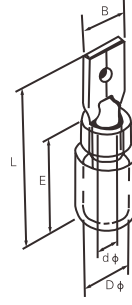

| Ürün Kodu      | Model Kodu  | Soket Ölçüsü | Kalınlık (mm) | Ebatlar |     |     |      |      | Renk    | Kablo Kesiti                    | Kutu Adet | Fiyat Adet (₺) |
|----------------|-------------|--------------|---------------|---------|-----|-----|------|------|---------|---------------------------------|-----------|----------------|
|                |             |              |               | B       | DØ  | dØ  | L    | E    |         |                                 |           |                |
| 014 100 060013 | IFE-1,5/2.8 | 0.8x2.8      | 0.8           | 2.8     | 1.7 | 3.8 | 17.7 | 10.0 | Kırmızı | 0.5 ~1.5 mm <sup>2</sup><br>10A | 200       | 1,84           |
| 014 100 060014 | IFE-1,5/4.8 | 0.4x4.75     | 0.4x2         | 4.8     | 1.7 | 3.8 | 20.0 | 10.0 |         |                                 | 200       | 2,10           |
| 014 100 060015 | IFE-1,5/6.4 | 0.8x6.35     | 0.4x2         | 6.4     | 1.7 | 3.8 | 21.0 | 10.0 |         |                                 | 200       | 2,63           |
| 014 100 060023 | IFE-2,5/2.8 | 0.8x2.8      | 0.8           | 2.8     | 2.3 | 4.3 | 17.7 | 10.0 | Mavi    | 1.5 ~2.5 mm <sup>2</sup><br>15A | 200       | 1,84           |
| 014 100 060024 | IFE-2,5/4.8 | 0.4x4.75     | 0.4x2         | 4.8     | 2.3 | 4.3 | 20.0 | 10.0 |         |                                 | 200       | 2,36           |
| 014 100 060025 | IFE-2,5/6.4 | 0.8x6.35     | 0.4x2         | 6.4     | 2.3 | 4.3 | 21.0 | 10.0 |         |                                 | 200       | 2,78           |
| 014 100 060040 | IFE-4       | 0.8x6.35     | 0.4x2         | 6.4     | 3.4 | 5.7 | 23.0 | 12.5 | Sarı    | 4 ~6 mm <sup>2</sup><br>24A     | 200       | 3,26           |

## YUVARLAK ERKEK TERMİNAL

Malzeme : Pirinç  
İzolasyon : PVC  
Voltaj : <600V  
Çalışma Sıcaklığı : Max. 75°

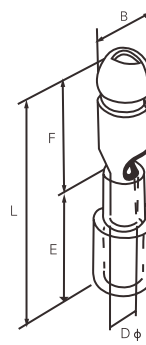

| Ürün Kodu      | Model Kodu  | Kalınlık mm | Ebatlar |     |     |      |      | Renk    | Kablo Kesiti                    | Kutu Adet | Fiyat Adet (₺) |
|----------------|-------------|-------------|---------|-----|-----|------|------|---------|---------------------------------|-----------|----------------|
|                |             |             | B       | F   | DØ  | E    | L    |         |                                 |           |                |
| 014 100 110510 | YET-0,5-1   | 0.4         | 4.0     | 8.5 | 1.7 | 10.5 | 21.5 | Kırmızı | 0.5 ~1.5 mm <sup>2</sup><br>10A | 200       | 6,51           |
| 014 100 111525 | YET-1,5-2,5 | 0.4         | 5.0     | 8.5 | 2.3 | 10.5 | 21.7 | Mavi    | 1.5 ~2.5 mm <sup>2</sup><br>15A | 200       | 7,46           |
| 014 100 114060 | YET-4-6     | 0.4         | 5.0     | 8.5 | 3.4 | 13.0 | 24.0 | Sarı    | 4 ~6 mm <sup>2</sup><br>24A     | 200       | 9,87           |

## İZOLELİ ERKEK - DİŞİ TERMİNAL

Malzeme : Pirinç  
İzolasyon : PVC  
Voltaj : <600V  
Çalışma Sıcaklığı : Max. 75°

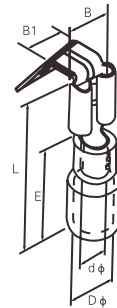

| Ürün Kodu      | Model Kodu   | Soket Ölçüsü | Ebatlar |      |      |     |     |      | Renk    | Kablo Kesiti                    | Kutu Adet | Fiyat Adet (₺) |
|----------------|--------------|--------------|---------|------|------|-----|-----|------|---------|---------------------------------|-----------|----------------|
|                |              |              | B       | B1   | E    | DØ  | dØ  | L    |         |                                 |           |                |
| 014 100 130515 | IEDT-0,5-1,5 | 0.8x6.35     | 6.6     | 6.35 | 10.0 | 3.8 | 1.7 | 22.5 | Kırmızı | 0.5 ~1.5 mm <sup>2</sup><br>10A | 100       | 5,36           |
| 014 100 131525 | IEDT-1,5-2,5 | 0.8x6.35     | 6.6     | 6.35 | 10.0 | 4.3 | 2.3 | 22.5 | Mavi    | 1.5 ~2.5 mm <sup>2</sup><br>15A | 100       | 5,88           |
| 014 100 134060 | IEDT-4-6     | 0.8x6.35     | 6.6     | 6.35 | 13.0 | 5.7 | 3.4 | 24.0 | Sarı    | 4 ~6 mm <sup>2</sup><br>24A     | 100       | 6,41           |

## İZOLELİ TAM DIŞI TERMİNAL

Malzeme : Bakır  
İzolasyon : PVC  
Voltaj : <600V  
Çalışma Sıcaklığı : Max. 75°

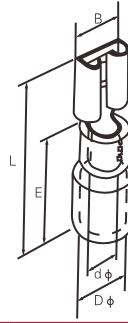

| Ürün Kodu      | Model Kodu      | Soket Ölçüsü | Kalınlık (mm) | Ebatlar |     |     |      |      | Renk    | Kablo Kesiti                    | Kutu Adet | Fiyat Adet (₺) |
|----------------|-----------------|--------------|---------------|---------|-----|-----|------|------|---------|---------------------------------|-----------|----------------|
|                |                 |              |               | B       | DØ  | dØ  | L    | E    |         |                                 |           |                |
| 014 100 080508 | IDT-0,5-1/2.8   | 0.8x2.8      | 0.3           | 3.3     | 3.8 | 1.7 | 18.5 | 10.0 | Kırmızı | 0.5 ~1.5 mm <sup>2</sup><br>10A | 200       | 1,68           |
| 014 100 080509 | IDT-0,5-1/4.8   | 0.8x4.75     | 0.35          | 5.0     | 3.8 | 1.7 | 19.0 | 10.0 |         |                                 | 200       | 2,21           |
| 014 100 080510 | IDT-0,5-1/6.4   | 0.8x6.35     | 0.4           | 6.6     | 3.8 | 1.7 | 19.8 | 10.0 |         |                                 | 200       | 2,89           |
| 014 100 081523 | IDT-1,5-2,5/2.8 | 0.8x2.8      | 0.3           | 3.3     | 4.3 | 2.3 | 18.5 | 10.0 | Mavi    | 1.5 ~2.5 mm <sup>2</sup><br>15A | 200       | 2,21           |
| 014 100 081524 | IDT-1,5-2,5/4.8 | 0.8x4.75     | 0.35          | 5.0     | 4.3 | 2.3 | 19.0 | 10.0 |         |                                 | 200       | 2,31           |
| 014 100 081525 | IDT-1,5-2,5/6.4 | 0.8x6.35     | 0.4           | 6.6     | 4.3 | 2.3 | 19.0 | 10.0 |         |                                 | 200       | 2,89           |
| 014 100 084060 | IDT-4-6         | 0.8x6.35     | 0.4           | 6.6     | 5.7 | 3.4 | 23.4 | 12.5 | Sarı    | 4 ~6 mm <sup>2</sup><br>24A     | 100       | 3,26           |

## TAM İZOLELİ FASTON EĞİK DIŞI TERMİNAL

Malzeme : Piriç  
İzolasyon : Nylon  
Voltaj : <600V  
Sıcaklık : 105° 400V

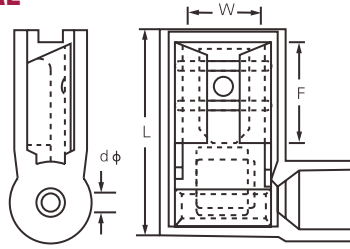

| Ürün Kodu      | Model Kodu   | Soket Ölçüsü | Ebatlar |     |      |     | Renk    | Kablo Kesiti                    | Kutu Adet | Fiyat Adet (₺) |
|----------------|--------------|--------------|---------|-----|------|-----|---------|---------------------------------|-----------|----------------|
|                |              |              | W       | F   | L    | dØ  |         |                                 |           |                |
| 014 100 140515 | TEDT-0,5-1,5 | 0.8x4.75     | 6.6     | 7.6 | 16.0 | 1.7 | Kırmızı | 0.5 ~1.5 mm <sup>2</sup><br>10A | 100       | 7,35           |
| 014 100 141525 | TEDT-1,5-2,5 | 0.8x6.35     | 6.6     | 7.6 | 16.0 | 2.3 | Mavi    | 1.5 ~2.5 mm <sup>2</sup><br>15A | 100       | 7,35           |
| 014 100 144060 | TEDT-4-6     | 0.8x6.35     | 7.0     | 7.6 | 17.5 | 3.4 | Sarı    | 4 ~6 mm <sup>2</sup><br>24A     | 100       | 23,18          |

## POLYAMİD TAM İZOLELİ DIŞI TERMİNAL

Malzeme : Piriç  
İzolasyon : Nylon  
Voltaj : <600V  
Sıcaklık : 105° 400V

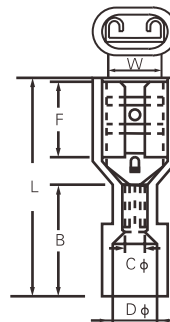

| Ürün Kodu      | Model Kodu       | Soket Ölçüsü | Ebatlar |      |      |      |     |     | Renk    | Kutu Adet | Fiyat Adet (₺) |
|----------------|------------------|--------------|---------|------|------|------|-----|-----|---------|-----------|----------------|
|                |                  |              | W       | F    | L    | B    | DØ  | CØ  |         |           |                |
| 014 100 150510 | TDTP-0,5-1/6.4   | 0.8x6.35     | 8.4     | 10.5 | 22.6 | 11.0 | 4.0 | 1.7 | Kırmızı | 200       | 7,41           |
| 014 100 151525 | TDTP-1,5-2,5/6.4 | 0.8x6.35     | 8.4     | 10.5 | 22.6 | 11.0 | 4.5 | 2.3 | Mavi    | 200       | 7,41           |
| 014 100 154060 | TDTP-4-6         | 0.8x6.35     | 8.6     | 10.5 | 24.0 | 13.0 | 6.3 | 3.4 | Sarı    | 100       | 9,26           |



## TOPRAKLAMA BARASI VE MESNEDİ

| Ürün Kodu      | Ürün Adı                           | Adet | Fiyat (₺) |
|----------------|------------------------------------|------|-----------|
| 034 025 040000 | TOPRAKLAMA BARASI 1,5 mm (31 VİDA) | 40   | 1.387,65  |
| 034 025 100001 | TOPRAKLAMA BARASI MESNEDİ          | 100  | 32,41     |

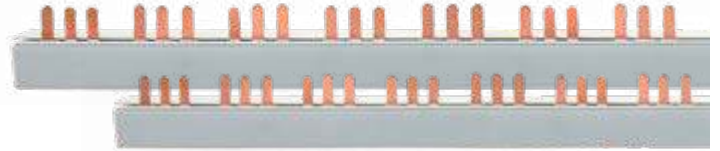

## TRİFAZE BARALAR

| Ürün Kodu      | Ürün Adı                                     | Adet | Fiyat (₺) |
|----------------|--|------|-----------|
| 034 025 040004 | TRİFAZE MÜŞTEREK BARA İÇNE UÇLU 80A - 53 cm  | 24   | 1.224,90  |
| 034 025 040005 | TRİFAZE MÜŞTEREK BARA İÇNE UÇLU 63A - 53 cm  | 24   | 985,06    |
| 034 025 040006 | TRİFAZE MÜŞTEREK BARA İÇNE UÇLU 80A - 106 cm | 24   | 2.449,80  |
| 034 025 040007 | TRİFAZE MÜŞTEREK BARA İÇNE UÇLU 63A - 106 cm | 24   | 1.970,12  |



## MONOFAZE BARALAR

| Ürün Kodu      | Ürün Adı                                | Adet | Fiyat (₺) |
|----------------|---|------|-----------|
| 034 025 040002 | MONOFAZE MÜŞTEREK BARA İÇNE UÇLU 106 cm | 50   | 849,72    |
| 034 025 040003 | MONOFAZE MÜŞTEREK BARA İÇNE UÇLU 53 cm  | 50   | 424,86    |



## 250 MİKRON BAKIR KAPLAMA TOPRAKLAMA ÇUBUĞU

| Ürün Kodu      | Ürün Adı   | Adet   | Fiyat (₺) |
|----------------|--|--------|-----------|
| 091 025 011610 | 16 mm 1 m TOPRAKLAMA ÇUBUĞU 250 MİKRON BAKIR KAPLAMA   | 10 ad. | 1.151,94  |
| 091 025 011615 | 16 mm 1,5 m TOPRAKLAMA ÇUBUĞU 250 MİKRON BAKIR KAPLAMA | 10 ad. | 1.651,12  |
| 091 025 012010 | 20 mm 1 m TOPRAKLAMA ÇUBUĞU 250 MİKRON BAKIR KAPLAMA   | 5 ad.  | 1.651,12  |
| 091 025 012015 | 20 mm 1,5 m TOPRAKLAMA ÇUBUĞU 250 MİKRON BAKIR KAPLAMA | 5 ad.  | 2.419,08  |

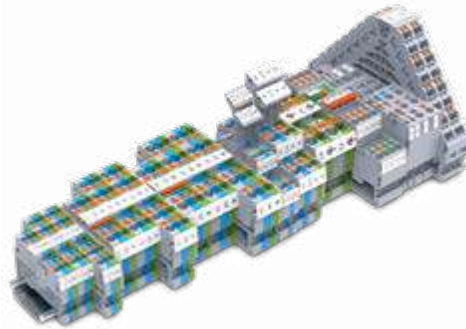

## RAYLAR

| Ürün Kodu            | Ürün Adı                              | Adet | Fiyat (₺) |
|----------------------|---------------------------------------|------|-----------|
| 001 025 020100 00 00 | KLEMENS RAYI(1m)                      | 25 m | 203,70    |
| 001 025 000100 00 00 | W OTOMAT RAYI (1m) (1m Fiyatı)        | 50 m | 100,00    |
| 001 025 000200 00 00 | W OTOMAT RAYI (2m) (1m Fiyatı)        | 50 m | 100,00    |
| 001 025 000033 00 00 | W OTOMAT RAYI (33 cm)                 | 50 m | 35,19     |
| 001 025 900100 00 00 | W OTOMAT RAYI(DELİKLİ)(1m)(1m Fiyatı) | 50 m | 111,11    |
| 001 025 900200 00 00 | W OTOMAT RAYI(DELİKLİ)(2m)(1m Fiyatı) | 50 m | 111,11    |

## EKO KABLO PABUÇLARI

| Ürün Kodu      | Ürün Adı                    | Civata | D3   | D2   | D1   | L  | A    | Kutu Adet | Fiyat (₺) |
|----------------|-----------------------------|--------|------|------|------|----|------|-----------|-----------|
| 123 037 000016 | 16-06 EKO TİP KABLO PABUCU  | M6     | 6,5  | 5,8  | 7,4  | 30 | 12   | 500       | 28,27     |
| 123 037 000025 | 25-08 EKO TİP KABLO PABUCU  | M8     | 8,5  | 7    | 9,2  | 40 | 14   | 350       | 46,26     |
| 123 037 000035 | 35-08 EKO TİP KABLO PABUCU  | M8     | 8,5  | 8,2  | 10,7 | 44 | 15,3 | 200       | 64,24     |
| 123 037 000050 | 50-10 EKO TİP KABLO PABUCU  | M10    | 10,5 | 10,2 | 12,8 | 52 | 20   | 150       | 82,23     |
| 123 037 000070 | 70-10 EKO TİP KABLO PABUCU  | M10    | 10,5 | 11,7 | 14,7 | 55 | 22   | 100       | 148,19    |
| 123 037 000095 | 95-12 EKO TİP KABLO PABUCU  | M12    | 13   | 13,6 | 16,7 | 59 | 26   | 70        | 166,18    |
| 123 037 000120 | 120-12 EKO TİP KABLO PABUCU | M12    | 13   | 15,5 | 19   | 70 | 29   | 50        | 228,71    |
| 123 037 000150 | 150-12 EKO TİP KABLO PABUCU | M12    | 13   | 16,7 | 21   | 77 | 32   | 40        | 349,48    |
| 123 037 000185 | 185-16 EKO TİP KABLO PABUCU | M16    | 17   | 18,8 | 23   | 85 | 35   | 30        | 422,29    |
| 123 037 000240 | 240-16 EKO TİP KABLO PABUCU | M16    | 17   | 21,2 | 26   | 90 | 38,5 | 24        | 645,86    |

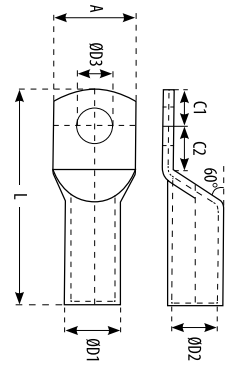

## STANDART KABLO PABUÇLARI

CE

| Ürün Kodu      | Ürün Adı                         | Civata | D3   | D2   | D1   | L    | A    | Kutu Adet | Fiyat (₺) |
|----------------|----------------------------------|--------|------|------|------|------|------|-----------|-----------|
| 123 037 500010 | 10-05 STANDART TİP KABLO PABUCU  | M5     | 5,2  | 4,7  | 6,5  | 27,5 | 10,5 | 800       | 27,41     |
| 123 037 500011 | 10-06 STANDART TİP KABLO PABUCU  | M6     | 6,5  | 4,7  | 6,5  | 27,5 | 10,5 | 800       | 27,41     |
| 123 037 500012 | 10-08 STANDART TİP KABLO PABUCU  | M8     | 8,5  | 4,7  | 6,5  | 27,5 | 10,5 | 800       | 27,41     |
| 123 037 500016 | 16-06 STANDART TİP KABLO PABUCU  | M6     | 6,5  | 5,8  | 7,4  | 30   | 12   | 500       | 41,12     |
| 123 037 500017 | 16-08 STANDART TİP KABLO PABUCU  | M8     | 8,5  | 5,8  | 7,8  | 30   | 12   | 500       | 41,12     |
| 123 037 500018 | 16-10 STANDART TİP KABLO PABUCU  | M10    | 10,5 | 5,8  | 7,8  | 30   | 12   | 500       | 41,12     |
| 123 037 500024 | 25-06 STANDART TİP KABLO PABUCU  | M6     | 6,5  | 7    | 9,2  | 40   | 14   | 350       | 68,53     |
| 123 037 500025 | 25-08 STANDART TİP KABLO PABUCU  | M8     | 8,5  | 7    | 9,2  | 40   | 14   | 350       | 68,53     |
| 123 037 500026 | 25-10 STANDART TİP KABLO PABUCU  | M10    | 10,5 | 7    | 9,5  | 40   | 14   | 350       | 68,53     |
| 123 037 500034 | 35-06 STANDART TİP KABLO PABUCU  | M6     | 6,5  | 8,2  | 10,7 | 44   | 15,3 | 200       | 94,22     |
| 123 037 500035 | 35-08 STANDART TİP KABLO PABUCU  | M8     | 8,5  | 8,2  | 10,7 | 44   | 15,3 | 200       | 94,22     |
| 123 037 500036 | 35-10 STANDART TİP KABLO PABUCU  | M10    | 10,5 | 8,2  | 10,7 | 44   | 15,3 | 200       | 94,22     |
| 123 037 500037 | 35-12 STANDART TİP KABLO PABUCU  | M12    | 13   | 8,2  | 10,7 | 44   | 15,3 | 200       | 94,22     |
| 123 037 500049 | 50-08 STANDART TİP KABLO PABUCU  | M8     | 8,5  | 10,2 | 12,8 | 52   | 20   | 150       | 143,05    |
| 123 037 500050 | 50-10 STANDART TİP KABLO PABUCU  | M10    | 10,5 | 10,2 | 12,8 | 52   | 20   | 150       | 143,05    |
| 123 037 500051 | 50-12 STANDART TİP KABLO PABUCU  | M12    | 13   | 10,2 | 12,8 | 52   | 20   | 150       | 143,05    |
| 123 037 500069 | 70-08 STANDART TİP KABLO PABUCU  | M8     | 8,5  | 11,7 | 14,7 | 55   | 22   | 100       | 179,88    |
| 123 037 500070 | 70-10 STANDART TİP KABLO PABUCU  | M10    | 10,5 | 11,7 | 14,7 | 55   | 22   | 100       | 179,88    |
| 123 037 500071 | 70-12 STANDART TİP KABLO PABUCU  | M12    | 13   | 11,7 | 14,7 | 55   | 22   | 100       | 179,88    |
| 123 037 500094 | 95-10 STANDART TİP KABLO PABUCU  | M10    | 10,5 | 13,6 | 16,7 | 59   | 26   | 70        | 221,85    |
| 123 037 500095 | 95-12 STANDART TİP KABLO PABUCU  | M12    | 13   | 13,6 | 16,7 | 59   | 26   | 70        | 221,85    |
| 123 037 500119 | 120-10 STANDART TİP KABLO PABUCU | M10    | 10,5 | 15,5 | 19   | 70   | 29   | 50        | 334,06    |
| 123 037 500120 | 120-12 STANDART TİP KABLO PABUCU | M12    | 13   | 15,5 | 19   | 70   | 29   | 50        | 334,06    |
| 123 037 500149 | 150-10 STANDART TİP KABLO PABUCU | M10    | 10,5 | 16,7 | 21   | 77   | 32   | 40        | 525,94    |
| 123 037 500150 | 150-12 STANDART TİP KABLO PABUCU | M12    | 13   | 16,7 | 21   | 77   | 32   | 40        | 525,94    |
| 123 037 500183 | 185-10 STANDART TİP KABLO PABUCU | M10    | 10,5 | 18,8 | 23   | 85   | 35   | 30        | 620,16    |
| 123 037 500184 | 185-12 STANDART TİP KABLO PABUCU | M12    | 13   | 18,8 | 23   | 85   | 35   | 30        | 620,16    |
| 123 037 500185 | 185-16 STANDART TİP KABLO PABUCU | M16    | 17   | 18,8 | 23   | 85   | 35   | 30        | 620,16    |
| 123 037 500238 | 240-10 STANDART TİP KABLO PABUCU | M10    | 10,5 | 21,2 | 26   | 90   | 38,5 | 24        | 829,16    |
| 123 037 500239 | 240-12 STANDART TİP KABLO PABUCU | M12    | 13   | 21,2 | 26   | 90   | 38,5 | 24        | 829,16    |
| 123 037 500240 | 240-16 STANDART TİP KABLO PABUCU | M16    | 17   | 21,2 | 26   | 90   | 38,5 | 24        | 829,16    |
| 123 037 500299 | 300-12 STANDART TİP KABLO PABUCU | M12    | 13   | 23,5 | 28,6 | 100  | 43   | 20        | 1.086,14  |
| 123 037 500300 | 300-16 STANDART TİP KABLO PABUCU | M16    | 17   | 23,5 | 28,6 | 100  | 43   | 20        | 1.086,14  |



## BORU TİP SIKMALI EK MUFLAR

| Ürün Kodu      | Ürün Adı                                    | D2   | D3   | L  | Kutu Adet | Fiyat (₺) |
|----------------|---|------|------|----|-----------|-----------|
| 123 037 300016 | 16 mm <sup>2</sup> BORU TİP SIKMALI EK MUF  | 5,8  | 7,4  | 30 | 500       | 28,27     |
| 123 037 300025 | 25 mm <sup>2</sup> BORU TİP SIKMALI EK MUF  | 7,2  | 9,2  | 40 | 300       | 49,68     |
| 123 037 300035 | 35 mm <sup>2</sup> BORU TİP SIKMALI EK MUF  | 8,5  | 11   | 44 | 200       | 67,67     |
| 123 037 300050 | 50 mm <sup>2</sup> BORU TİP SIKMALI EK MUF  | 10   | 13   | 52 | 150       | 87,37     |
| 123 037 300070 | 70 mm <sup>2</sup> BORU TİP SIKMALI EK MUF  | 11,5 | 14,7 | 55 | 100       | 158,47    |
| 123 037 300095 | 95 mm <sup>2</sup> BORU TİP SIKMALI EK MUF  | 13,5 | 16,7 | 59 | 70        | 175,60    |
| 123 037 300120 | 120 mm <sup>2</sup> BORU TİP SIKMALI EK MUF | 15,6 | 19   | 70 | 50        | 241,55    |
| 123 037 300150 | 150 mm <sup>2</sup> BORU TİP SIKMALI EK MUF | 17   | 21   | 77 | 40        | 373,47    |
| 123 037 300185 | 185 mm <sup>2</sup> BORU TİP SIKMALI EK MUF | 19   | 23   | 85 | 30        | 457,41    |
| 123 037 300240 | 240 mm <sup>2</sup> BORU TİP SIKMALI EK MUF | 21   | 26   | 90 | 24        | 685,26    |



**KOLAY MONTAJ**  
**İSTER FİŞ OLSUN İSTER PRİZ!!**  
**DUVARDAN, MAKİNADAN**  
**SÖKMEYEN TEK TUŞLA DEĞİŞİM**  
**YAPABİLİRSİNİZ...**



010 083 041516  
010 083 041532

010 083 051516  
010 083 051532

010 083 021516  
010 083 021532

010 083 001516  
010 083 001532

010 083 011516  
010 083 011532

010 083 061516  
010 083 061532

## MUTLUSAN CEE NORM SANAYİ TİPİ FİŞ - PRİZ GRUBU (TRİFAZE)



| Ürün Kodu      | Ürün Adı  | Kutu / Adet | Koli / Adet | Fiyat (₺) |
|----------------|---|-------------|-------------|-----------|
| 010 083 041516 | MUT-105 CEE NORM 5X16A DUVAR FİŞİ (TUŞ KİLİTLİ)     | 8           | 64          | 644,83    |
| 010 083 051516 | MUT-106 CEE NORM 5X16A MAKİNE FİŞİ (TUŞ KİLİTLİ)    | 20          | 160         | 507,62    |
| 010 083 021516 | MUT-107 CEE NORM 5X16A MAKİNE PRİZİ (TUŞ KİLİTLİ)   | 20          | 160         | 570,88    |
| 010 083 001516 | MUT-108 CEE NORM 5X16A DÜZ FİŞ ÜST MEKANİZMA        | 25          | 200         | 384,76    |
| 010 083 011516 | MUT-109 CEE NORM 5X16A UZATMA PRİZİ ÜST MEKANİZMA   | 25          | 200         | 456,49    |
| 010 083 061516 | MUT-116 CEE NORM 5X16A TUŞ KİLİTLİ FİŞ PRİZ APARATI | 25          | 750         | 130,43    |
| 010 083 041532 | MUT-205 CEE NORM 5X32A DUVAR FİŞİ (TUŞ KİLİTLİ)     | 8           | 64          | 824,95    |
| 010 083 051532 | MUT-206 CEE NORM 5X32A MAKİNE FİŞİ (TUŞ KİLİTLİ)    | 20          | 160         | 680,31    |
| 010 083 021532 | MUT-207 CEE NORM 5X32A MAKİNE PRİZİ (TUŞ KİLİTLİ)   | 20          | 160         | 686,30    |
| 010 083 001532 | MUT-208 CEE NORM 5X32A DÜZ FİŞ ÜST MEKANİZMA        | 25          | 200         | 521,71    |
| 010 083 011532 | MUT-209 CEE NORM 5X32A UZATMA PRİZİ ÜST MEKANİZMA   | 25          | 200         | 554,31    |
| 010 083 061532 | MUT-216 CEE NORM 5X32A TUŞ KİLİTLİ FİŞ PRİZ APARATI | 25          | 750         | 130,43    |

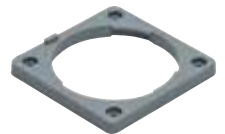

010 083 041416  
010 083 041432

010 083 051416  
010 083 051432

010 083 021416  
010 083 021432

010 083 001416  
010 083 001432

010 083 011416  
010 083 011432

010 083 061416  
010 083 061432

## MUTLUSAN CEE NORM SANAYİ TİPİ FİŞ - PRİZ GRUBU (TRİFAZE)



| Ürün Kodu      | Ürün Adı  | Kutu / Adet | Koli / Adet | Fiyat (₺) |
|----------------|---|-------------|-------------|-----------|
| 010 083 041416 | MUT-405 CEE NORM 4X16A DUVAR FİŞİ (TUŞ KİLİTLİ)     | 8           | 64          | 670,59    |
| 010 083 051416 | MUT-406 CEE NORM 4X16A MAKİNE FİŞİ (TUŞ KİLİTLİ)    | 20          | 160         | 473,25    |
| 010 083 021416 | MUT-407 CEE NORM 4X16A MAKİNE PRİZİ (TUŞ KİLİTLİ)   | 20          | 160         | 526,53    |
| 010 083 001416 | MUT-408 CEE NORM 4X16A DÜZ FİŞ ÜST MEKANİZMA        | 30          | 240         | 320,33    |
| 010 083 011416 | MUT-409 CEE NORM 4X16A UZATMA PRİZİ ÜST MEKANİZMA   | 30          | 240         | 433,02    |
| 010 083 061416 | MUT-416 CEE NORM 4X16A TUŞ KİLİTLİ FİŞ PRİZ APARATI | 30          | 900         | 130,43    |
| 010 083 041432 | MUT-450 CEE NORM 4X32A DUVAR FİŞİ (TUŞ KİLİTLİ)     | 8           | 64          | 766,26    |
| 010 083 051432 | MUT-460 CEE NORM 4X32A MAKİNE FİŞİ (TUŞ KİLİTLİ)    | 20          | 160         | 650,76    |
| 010 083 021432 | MUT-470 CEE NORM 4X32A MAKİNE PRİZİ (TUŞ KİLİTLİ)   | 20          | 160         | 624,09    |
| 010 083 001432 | MUT-480 CEE NORM 4X32A DÜZ FİŞ ÜST MEKANİZMA        | 25          | 200         | 489,36    |
| 010 083 011432 | MUT-490 CEE NORM 4X32A UZATMA PRİZİ ÜST MEKANİZMA   | 25          | 200         | 548,84    |
| 010 083 061432 | MUT-432 CEE NORM 4X32A TUŞ KİLİTLİ FİŞ PRİZ APARATI | 25          | 750         | 130,43    |



010 083 041316  
010 083 041332

010 083 051316  
010 083 051332

010 083 021316  
010 083 021332

010 083 001316  
010 083 001332

010 083 011316  
010 083 011332

010 083 061316  
010 083 061332

## MUTLUSAN CEE NORM SANAYİ TİPİ FİŞ - PRİZ GRUBU (MONOFAZE)



| Ürün Kodu      | Ürün Adı  | Kutu / Adet | Koli / Adet | Fiyat (₺) |
|----------------|---|-------------|-------------|-----------|
| 010 083 041316 | MUT-305 CEE NORM 16A DUVAR FİŞİ (TUŞ KİLİTLİ)     | 8           | 64          | 565,27    |
| 010 083 051316 | MUT-306 CEE NORM 16A MAKİNE FİŞİ (TUŞ KİLİTLİ)    | 20          | 160         | 384,50    |
| 010 083 021316 | MUT-307 CEE NORM 16A MAKİNE PRİZİ ( TUŞ KİLİTLİ)  | 20          | 160         | 422,13    |
| 010 083 001316 | MUT-308 CEE NORM 16A DÜZ FİŞ ÜST MEKANİZMA        | 30          | 240         | 235,81    |
| 010 083 011316 | MUT-309 CEE NORM 16A UZATMA PRİZİ ÜST MEKANİZMA   | 30          | 240         | 271,61    |
| 010 083 061316 | MUT-316 CEE NORM 16A TUŞ KİLİTLİ FİŞ PRİZ APARATI | 30          | 750         | 130,43    |
| 010 083 041332 | MUT-350 CEE NORM 32A DUVAR FİŞİ (TUŞ KİLİTLİ)     | 8           | 64          | 689,50    |
| 010 083 051332 | MUT-360 CEE NORM 32A MAKİNE FİŞİ (TUŞ KİLİTLİ)    | 20          | 160         | 579,81    |
| 010 083 021332 | MUT-370 CEE NORM 32A MAKİNE PRİZİ ( TUŞ KİLİTLİ)  | 20          | 160         | 544,27    |
| 010 083 001332 | MUT-380 CEE NORM 32A DÜZ FİŞ ÜST MEKANİZMA        | 25          | 200         | 421,80    |
| 010 083 011332 | MUT-390 CEE NORM 32A UZATMA PRİZİ ÜST MEKANİZMA   | 25          | 200         | 461,51    |
| 010 083 061332 | MUT-332 CEE NORM 32A TUŞ KİLİTLİ FİŞ PRİZ APARATI | 25          | 750         | 130,43    |



010 083 071563  
010 083 081563

010 083 091563  
010 083 011563

010 083 021563  
010 083 101563

010 083 051563  
010 083 111563

## MUTLUSAN CEE NORM SANAYİ TİPİ FİŞ - PRİZ GRUBU (TRİFAZE - IP44)



| Ürün Kodu      | Ürün Adı   | Kutu / Adet | Koli / Adet | Fiyat (₺) |
|----------------|--|-------------|-------------|-----------|
| 010 083 071563 | MUT-501 CEE NORM 5X63A ERKEK FİŞ IP44            | 4           | 32          | 2.328,12  |
| 010 083 011563 | MUT-502 CEE NORM 5X63A UZATMA PRİZİ IP44         | 4           | 32          | 3.012,86  |
| 010 083 021563 | MUT-503 CEE NORM 5X63A MAKİNE PRİZİ IP44         | 6           | 48          | 2.491,08  |
| 010 083 051563 | MUT-504 CEE NORM 5X63A MAKİNE FİŞİ IP44          | 6           | 48          | 2.491,08  |
| 010 083 081563 | MUT-509 CEE NORM 5X63A ERKEK FİŞ PİLOTLU IP44    | 4           | 32          | 2.444,52  |
| 010 083 091563 | MUT-510 CEE NORM 5X63A UZATMA PRİZİ PİLOTLU IP44 | 4           | 32          | 3.163,50  |
| 010 083 101563 | MUT-511 CEE NORM 5X63A MAKİNE PRİZİ PİLOTLU IP44 | 6           | 48          | 2.615,64  |
| 010 083 111563 | MUT-512 CEE NORM 5X63A MAKİNE FİŞİ PİLOTLU IP44  | 6           | 48          | 2.615,64  |



010 083 092563  
010 083 012563

010 083 072563  
010 083 082563

010 083 072563  
010 083 082563

010 083 052563  
010 083 112563

## MUTLUSAN CEE NORM SANAYİ TİPİ FİŞ - PRİZ GRUBU (TRİFAZE - IP67)



| Ürün Kodu      | Ürün Adı   | Kutu / Adet | Koli / Adet | Fiyat (₺) |
|----------------|--|-------------|-------------|-----------|
| 010 083 072563 | MUT-505 CEE NORM 5X63A ERKEK FİŞ IP67            | 4           | 32          | 2.584,21  |
| 010 083 012563 | MUT-506 CEE NORM 5X63A UZATMA PRİZİ IP67         | 4           | 32          | 3.223,75  |
| 010 083 022563 | MUT-507 CEE NORM 5X63A MAKİNE PRİZİ IP67         | 6           | 48          | 2.864,75  |
| 010 083 052563 | MUT-508 CEE NORM 5X63A MAKİNE FİŞİ IP67          | 6           | 48          | 2.864,75  |
| 010 083 082563 | MUT-513 CEE NORM 5X63A ERKEK FİŞ PİLOTLU IP67    | 4           | 32          | 2.713,42  |
| 010 083 092563 | MUT-514 CEE NORM 5X63A UZATMA PRİZİ PİLOTLU IP67 | 4           | 32          | 3.384,94  |
| 010 083 102563 | MUT-515 CEE NORM 5X63A MAKİNE PRİZİ PİLOTLU IP67 | 6           | 48          | 3.007,98  |
| 010 083 112563 | MUT-516 CEE NORM 5X63A MAKİNE FİŞİ PİLOTLU IP67  | 6           | 48          | 3.007,98  |



010 083 000516  
010 083 000532



010 083 010516  
010 083 010532



010 083 020516  
010 083 020532



010 083 030516  
010 083 030532

## MUTLUSAN CEE NORM SANAYİ TİPİ FİŞ - PRİZ GRUBU (TRİFAZE)



| Ürün Kodu      | Ürün Adı                            | Kutu / Adet | Koli / Adet | Fiyat (₺) |
|----------------|-------------------------------------|-------------|-------------|-----------|
| 010 083 000516 | MUT-101 CEE NORM 5x16A DÜZ FİŞ      | 16          | 128         | 442,03    |
| 010 083 010516 | MUT-102 CEE NORM 5x16A UZATMA PRİZİ | 15          | 120         | 561,55    |
| 010 083 020516 | MUT-103 CEE NORM 5x16A MAKİNE PRİZİ | 20          | 160         | 497,19    |
| 010 083 030516 | MUT-104 CEE NORM 5x16A DUVAR PRİZİ  | 8           | 64          | 618,91    |
| 010 083 000532 | MUT-201 CEE NORM 5x32A DÜZ FİŞ      | 14          | 112         | 592,46    |
| 010 083 010532 | MUT-202 CEE NORM 5x32A UZATMA PRİZİ | 12          | 96          | 686,91    |
| 010 083 020532 | MUT-203 CEE NORM 5x32A MAKİNE PRİZİ | 14          | 112         | 597,61    |
| 010 083 030532 | MUT-204 CEE NORM 5x32A DUVAR PRİZİ  | 8           | 64          | 718,72    |



010 083 000416  
010 083 000432



010 083 010416  
010 083 010432



010 083 020416  
010 083 020432

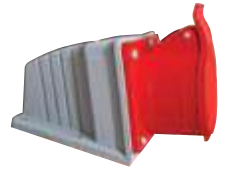

010 083 030416  
010 083 030432

## MUTLUSAN CEE NORM SANAYİ TİPİ FİŞ - PRİZ GRUBU (TRİFAZE)



| Ürün Kodu      | Ürün Adı                            | Kutu / Adet | Koli / Adet | Fiyat (₺) |
|----------------|-------------------------------------|-------------|-------------|-----------|
| 010 083 000416 | MUT-401 CEE NORM 4/16A DÜZ FİŞ      | 16          | 128         | 412,15    |
| 010 083 010416 | MUT-402 CEE NORM 4/16A UZATMA PRİZ  | 15          | 120         | 515,19    |
| 010 083 020416 | MUT-403 CEE NORM 4/16A MAKİNE PRİZİ | 20          | 160         | 458,51    |
| 010 083 030416 | MUT-404 CEE NORM 4/16A DUVAR PRİZİ  | 8           | 64          | 583,88    |
| 010 083 000432 | MUT-410 CEE NORM 4/32A DÜZ FİŞ      | 14          | 112         | 566,70    |
| 010 083 010432 | MUT-420 CEE NORM 4/32A UZATMA PRİZ  | 12          | 96          | 620,97    |
| 010 083 020432 | MUT-430 CEE NORM 4/32A MAKİNE PRİZİ | 14          | 112         | 543,55    |
| 010 083 030432 | MUT-440 CEE NORM 4/32A DUVAR PRİZİ  | 8           | 64          | 667,20    |



010 083 000316  
010 083 000332



010 083 010316  
010 083 010332



010 083 020316  
010 083 020332



010 083 030316  
010 083 030332

## MUTLUSAN CEE NORM SANAYİ TİPİ FİŞ - PRİZ GRUBU (MONOFAZE)



| Ürün Kodu      | Ürün Adı                          | Kutu / Adet | Koli / Adet | Fiyat (₺) |
|----------------|-----------------------------------|-------------|-------------|-----------|
| 010 083 000316 | MUT-301 CEE NORM 16A DÜZ FİŞ      | 16          | 128         | 334,87    |
| 010 083 010316 | MUT-302 CEE NORM 16A UZATMA PRİZ  | 15          | 120         | 389,00    |
| 010 083 020316 | MUT-303 CEE NORM 16A MAKİNE PRİZİ | 20          | 160         | 367,50    |
| 010 083 030316 | MUT-304 CEE NORM 16A DUVAR PRİZİ  | 8           | 64          | 492,17    |
| 010 083 000332 | MUT-310 CEE NORM 32A DÜZ FİŞ      | 12          | 112         | 504,88    |
| 010 083 010332 | MUT-320 CEE NORM 32A UZATMA PRİZ  | 12          | 96          | 541,29    |
| 010 083 020332 | MUT-330 CEE NORM 32A MAKİNE PRİZİ | 14          | 112         | 473,97    |
| 010 083 030332 | MUT-340 CEE NORM 32A DUVAR PRİZİ  | 8           | 64          | 600,36    |



010 083 500298



010 083 501297



010 083 500297



010 083 500299



010 083 502910

## MUTLUSAN SANAYİ TİPİ FİŞ - PRİZ GRUBU (MONOFAZE)

CE

| Ürün Kodu      | Ürün Adı  | Kutu / Adet | Koli / Adet | Fiyat (₺) |
|----------------|---|-------------|-------------|-----------|
| 010 083 500298 | MUT-29/8 MONOFAZE 16A TOPRAKLI PANO PRİZİ       | 40          | 320         | 105,47    |
| 010 083 501297 | MUT-29/8-U MONOFAZE 16A UPS TOPRAKLI PANO PRİZİ | 40          | 320         | 128,80    |
| 010 083 500297 | MUT-29/7 MONOFAZE 16A DUVAR PRİZİ               | 30          | 240         | 170,11    |
| 010 083 500299 | MUT-29/9 MONOFAZE 16A MAKİNE PRİZİ              | 20          | 160         | 214,34    |
| 010 083 502910 | MUT-29/10 MONOFAZE 16A DUVAR PRİZİ              | 15          | 120         | 284,66    |

010 083 400064  
010 083 400318  
010 083 400074



010 083 400063  
010 083 400319  
010 083 400073



## MUTLUSAN SANAYİ TİPİ FİŞ - PRİZ GRUBU (MONOFAZE)

CE

| Ürün Kodu      | Ürün Adı                           | Kutu / Adet | Koli / Adet | Fiyat (₺) |
|----------------|------------------------------------|-------------|-------------|-----------|
| 010 083 400064 | MUT-64 16A MONOFAZE MAKİNE PRİZİ   | 20          | 160         | 341,36    |
| 010 083 400063 | MUT-63 16A MONOFAZE DUVAR PRİZİ    | 12          | 96          | 382,19    |
| 010 083 400318 | MUT-31/8 25A MONOFAZE MAKİNE PRİZİ | 20          | 160         | 286,90    |
| 010 083 400319 | MUT-31/9 25A MONOFAZE DUVAR PRİZİ  | 15          | 120         | 365,77    |
| 010 083 400074 | MUT-74 32A MONOFAZE MAKİNE PRİZİ   | 20          | 160         | 419,49    |
| 010 083 400073 | MUT-73 32A MONOFAZE DUVAR PRİZİ    | 12          | 96          | 491,50    |



010 083 300027



010 083 300028



010 083 300029



010 083 301029



010 083 500296



010 083 502294



010 083 500293

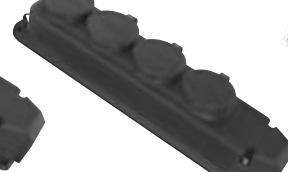

010 083 500294



010 083 501292



010 083 501293



010 083 500292

## MUTLUSAN KAUÇUK SANAYİ TİPİ FİŞ - PRİZ GRUBU (MONOFAZE)

CE

| Ürün Kodu           | Ürün Adı  | Kutu / Adet | Koli / Adet | Fiyat (₺) |
|---------------------|---|-------------|-------------|-----------|
| 010 083 300027      | MUT-27 16A MONOFAZE TOPRAKLI ERKEK FİŞ (EĞİK)   | 40          | 320         | 100,46    |
| 010 083 300028      | MUT-28 16A MONOFAZE TOPRAKLI ERKEK FİŞ (DÜZ)    | 40          | 320         | 100,46    |
| 010 083 300029      | MUT-29 16A MONOFAZE TOPRAKLI DIŞI FİŞ           | 25          | 200         | 154,56    |
| YENİ 010 083 301029 | OLİMPİA MUT-29 16A MONOFAZE TOPRAKLI DIŞI FİŞ   | 25          | 200         | 127,31    |
| 010 083 500296      | MUT-29/6 16A MONOFAZE TOPRAKLI DUVAR PRİZ       | 20          | 160         | 195,77    |
| 010 083 500293      | MUT-29/3 16A MONOFAZE 3'LÜ GRUP PRİZ            | 12          | 96          | 311,69    |
| YENİ 010 083 502293 | OLİMPİA MUT-29/3 16A MONOFAZE 3'LÜ GRUP PRİZ    | 12          | 96          | 266,20    |
| 010 083 500294      | MUT-29/4 16A MONOFAZE 4'LÜ GRUP PRİZ            | 10          | 80          | 396,93    |
| 010 083 501292      | MUT-29/2A 16A MONOFAZE 2'Lİ GRUP PRİZ ANAHTARLI | 12          | 96          | 568,76    |
| 010 083 501293      | MUT-29/3A 16A MONOFAZE 3'LÜ GRUP PRİZ ANAHTARLI | 10          | 80          | 654,70    |
| 010 083 500292      | MUT-29/2 16A MONOFAZE 2'Lİ GRUP PRİZ            | 14          | 112         | 243,85    |



010 083 400030    010 083 400031    010 083 600315    010 083 600311    010 083 600312    010 083 600313    010 083 600316    010 083 600317

## MUTLUSAN KAUCUK SANAYİ TİPİ FİŞ - PRİZ GRUBU (TRİFAZE)



| Ürün Kodu      | Ürün Adı                                  | Kutu / Adet | Koli / Adet | Fiyat (₺) |
|----------------|---|-------------|-------------|-----------|
| 010 083 400030 | MUT-30 25A TRİFAZE ERKEK FİŞ              | 25          | 200         | 195,77    |
| 010 083 400031 | MUT-31 25A TRİFAZE DIŞI FİŞ (SEYYAR)      | 20          | 160         | 308,62    |
| 010 083 600315 | MUT-31/5 25A TRİFAZE DUVAR PRİZ           | 20          | 160         | 365,77    |
| 010 083 600311 | MUT-31/1 1 TRİFAZE + 1 MONOFAZE GRUP PRİZ | 10          | 80          | 664,67    |
| 010 083 600312 | MUT-31/2 TRİFAZE GRUP PRİZ - 2'Lİ         | 10          | 80          | 736,04    |
| 010 083 600313 | MUT-31/3 TRİFAZE GRUP PRİZ - 3'LÜ         | 10          | 80          | 839,08    |
| 010 083 600316 | MUT-31/6 2 TRİFAZE + 1 MONOFAZE GRUP PRİZ | 10          | 80          | 839,08    |
| 010 083 600317 | MUT-31/7 1 TRİFAZE + 2 MONOFAZE GRUP PRİZ | 10          | 80          | 839,08    |



010 083 400060  
010 083 400070



010 083 400061  
010 083 400071



010 083 400062  
010 083 400072

## MUTLUSAN KAUCUK SANAYİ TİPİ FİŞ - PRİZ GRUBU (TRİFAZE)



| Ürün Kodu      | Ürün Adı                           | Kutu / Adet | Koli / Adet | Fiyat (₺) |
|----------------|------------------------------------|-------------|-------------|-----------|
| 010 083 400060 | MUT-60 16A TRİFAZE ERKEK FİŞ       | 30          | 240         | 340,23    |
| 010 083 400061 | MUT-61 16A TRİFAZE SEYYAR DIŞI FİŞ | 25          | 200         | 416,21    |
| 010 083 400062 | MUT-62 16A TRİFAZE DUVAR PRİZİ     | 20          | 160         | 521,68    |
| 010 083 400070 | MUT-70 32A TRİFAZE ERKEK FİŞ       | 20          | 160         | 491,50    |
| 010 083 400071 | MUT-71 32A TRİFAZE SEYYAR DIŞI FİŞ | 15          | 120         | 560,08    |
| 010 083 400072 | MUT-72 32A TRİFAZE DUVAR PRİZİ     | 20          | 160         | 737,25    |

## SANAYİ TİPİ FİŞ - PRİZLER

| Ürün Kodu      | Ürün Adı                   | Kutu Adet | Fiyat (₺) |
|----------------|----------------------------|-----------|-----------|
| 019 107 016250 | 16/25A 4 KUTUPLU FİŞ-PRİZ  | 30        | 1.627,01  |
| 019 107 016252 | 16/25A 4 KUTUPLU PRİZ      | 45        | 861,39    |
| 019 107 016251 | 16/25A 4 KUTUPLU FİŞ       | 60        | 765,63    |
| 019 107 025400 | 25/40A 4 KUTUPLU FİŞ-PRİZ  | 15        | 2.089,79  |
| 019 107 025402 | 25/40A 4 KUTUPLU PRİZ      | 25        | 1.082,08  |
| 019 107 025401 | 25/40A 4 KUTUPLU FİŞ       | 35        | 1.007,71  |
| 019 107 040630 | 40/63A 4 KUTUPLU FİŞ-PRİZ  | 10        | 2.706,18  |
| 019 107 040632 | 40/63A 4 KUTUPLU PRİZ      | 15        | 1.391,74  |
| 019 107 040631 | 40/63A 4 KUTUPLU FİŞ       | 25        | 1.314,44  |
| 019 107 063100 | 63/100A 4 KUTUPLU FİŞ-PRİZ | 5         | 4.301,11  |
| 019 107 063102 | 63/100A 4 KUTUPLU PRİZ     | 10        | 2.228,33  |
| 019 107 063101 | 63/100A 4 KUTUPLU FİŞ      | 15        | 2.072,78  |



## SANAYİ TİPİ SEYYAR PRİZLER

| Ürün Kodu      | Ürün Adı                      | Kutu Adet | Fiyat (₺) |
|----------------|-------------------------------|-----------|-----------|
| 019 107 016253 | 16/25A 4 KUTUPLU SEYYAR PRİZ  | 45        | 861,39    |
| 019 107 025403 | 25/40A 4 KUTUPLU SEYYAR PRİZ  | 25        | 1.082,08  |
| 019 107 040633 | 40/63A 4 KUTUPLU SEYYAR PRİZ  | 15        | 1.391,74  |
| 019 107 063103 | 63/100A 4 KUTUPLU SEYYAR PRİZ | 10        | 2.228,33  |

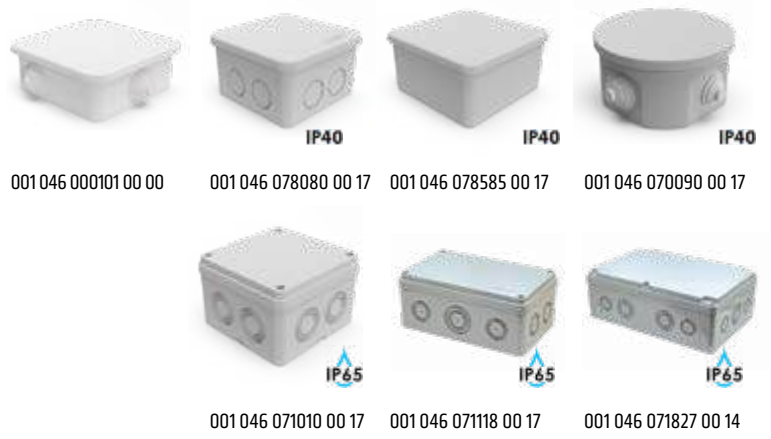

## TERMOPLASTİK BUATLAR (GRİ-BEYAZ)

| Gri Kodu                         | Beyaz Kodu           | Ürün Adı  | Kutu Adet | Koli Adet | Gri Fiyat (₺) | Beyaz Fiyat (₺) |
|----------------------------------|----------------------|---|-----------|-----------|---------------|-----------------|
| -                                | 001 046 000101 00 00 | 85x85 KARE ANTİGRON BUAT                                | 10        | 300       |               | 48,98           |
| 001 046 078080 00 17             | 001 046 078080 00 00 | 80x80x48 (7 ÇIKIŞLI) TERMOPLASTİK BUAT                  | 18        | 108       | 78,35         | 83,25           |
| 001 046 078585 00 17             | 001 046 078585 00 00 | 85x85x48 TERMOPLASTİK BUAT                              | 18        | 108       | 73,46         | 78,35           |
| 001 046 070090 00 17             | 001 046 070090 00 00 | Ø90 TERMOPLASTİK BUAT                                   | 18        | 108       | 132,22        | 142,02          |
| <b>YENİ</b> 001 046 070110 00 17 | 001 046 070110 00 00 | 110x110x74 (8 ÇIKIŞ) TERMOPLASTİK BUAT - TIRNAKLI KAPAK | 10        | 40        | 142,04        | 171,41          |
| 001 046 071010 00 17             | 001 046 071010 00 00 | 110x110x74 (8 ÇIKIŞ) TERMOPLASTİK BUAT                  | 10        | 40        | 142,02        | 171,40          |
| 001 046 071118 00 17             | 001 046 071118 00 00 | 110x180x77 (10 ÇIKIŞ) TERMOPLASTİK BUAT                 | 5         | 30        | 220,37        | 284,03          |
| 001 046 071827 00 17             | 001 046 071827 00 00 | 180x270x100 (14 ÇIKIŞ) TERMOPLASTİK BUAT                | 2         | 8         | 612,14        | 685,60          |



001 046 072698 00 44



001 046 072698 00 17



001 046 076131 00 44



001 046 076131 00 17



001 046 078226 00 17

## TERMOPLASTİK BUATLAR VE KOMBİNASYON KUTULARI

| Ürün Kodu            | Ürün Adı                                       | Koli Adet | Fiyat (₺) |
|----------------------|--|-----------|-----------|
| 001 046 072698 00 44 | 138x226x98 TERMOPLASTİK BUAT (ŞEFFAF KAPAKLI)  | 8         | 576,13    |
| 001 046 072698 00 17 | 138x226x98 TERMOPLASTİK BUAT                   | 8         | 504,12    |
| 001 046 076131 00 44 | 138x226x131 TERMOPLASTİK BUAT (ŞEFFAF KAPAKLI) | 8         | 576,13    |
| 001 046 076131 00 17 | 138x226x131 TERMOPLASTİK BUAT                  | 8         | 552,13    |
| 001 046 078226 00 17 | 138x226x127 KOMBİNASYON KUTUSU                 | 8         | 624,14    |



001 046 071199 00 44



001 046 071199 00 17



001 046 071130 00 44



001 046 071130 00 17



001 046 075311 00 17

## TERMOPLASTİK BUATLAR VE KOMBİNASYON KUTULARI

| Ürün Kodu            | Ürün Adı                                       | Koli Adet | Fiyat (₺) |
|----------------------|--|-----------|-----------|
| 001 046 071199 00 44 | 225x311x99 TERMOPLASTİK BUAT (ŞEFFAF KAPAKLI)  | 4         | 888,21    |
| 001 046 071199 00 17 | 225x311x99 TERMOPLASTİK BUAT                   | 4         | 720,17    |
| 001 046 071130 00 44 | 225x311x130 TERMOPLASTİK BUAT (ŞEFFAF KAPAKLI) | 4         | 888,21    |
| 001 046 071130 00 17 | 225x311x130 TERMOPLASTİK BUAT                  | 4         | 720,17    |
| 001 046 075311 00 17 | 225x311x132 KOMBİNASYON KUTUSU                 | 4         | 1.008,23  |

**YENİ**



001 046 098080 00 17

001 046 098585 00 17

001 046 090090 00 17



001 046 091010 00 17

001 046 091118 00 17

001 046 091827 00 17

## ALEV YAYMAYAN TERMOPLASTİK BUATLAR (GRİ-BEYAZ)



| Grİ Kodu             | BeYaz Kodu           | Ürün Adı   | Kutu Adet | Koli Adet | Grİ Fiyat (₺) | BeYaz Fiyat (₺) |
|----------------------|----------------------|--|-----------|-----------|---------------|-----------------|
| 001 046 098080 00 17 | -                    | 80x80x48 (7 ÇIKIŞLI) TERMOPLASTİK BUAT - ALEV YAYMAYAN               | 18        | 108       | 118,68        | -               |
| 001 046 098585 00 17 | 001 046 098585 00 00 | 85x85x48 TERMOPLASTİK BUAT - ALEV YAYMAYAN                           | 18        | 108       | 138,46        | 138,46          |
| 001 046 090090 00 17 | 001 046 090090 00 00 | Ø90 TERMOPLASTİK BUAT - ALEV YAYMAYAN                                | 18        | 108       | 128,58        | 128,58          |
| 001 046 090110 00 17 | 001 046 090110 00 00 | 110x110x74 (8 ÇIKIŞ) TERMOPLASTİK BUAT - TIRNAKLI KAPAK - A.YAYMAYAN | 10        | 40        | 296,70        | 296,70          |
| 001 046 091010 00 17 | 001 046 091010 00 00 | 110x110x74 (8 ÇIKIŞ) TERMOPLASTİK BUAT - ALEV YAYMAYAN               | 10        | 40        | 296,70        | 296,70          |
| 001 046 091118 00 17 | 001 046 091118 00 00 | 110x180x77 (10 ÇIKIŞ) TERMOPLASTİK BUAT - ALEV YAYMAYAN              | 5         | 30        | 519,24        | 519,24          |
| 001 046 091827 00 17 | 001 046 091827 00 00 | 180x270x100 (14 ÇIKIŞ) TERMOPLASTİK BUAT - ALEV YAYMAYAN             | 2         | 8         | 1.137,38      | 1.137,38        |



001 046 092698 00 44



001 046 092698 00 17



001 046 096131 00 44



001 046 096131 00 17



001 046 098226 00 17

## ALEV YAYMAYAN TERMOPLASTİK BUATLAR VE KOMBİNASYON KUTULARI

| Ürün Kodu            | Ürün Adı   | Koli Adet | Fiyat (₺) |
|----------------------|--|-----------|-----------|
| 001 046 092698 00 44 | 138x226x98 TERMOPLASTİK BUAT (ŞEFFAF KAPAKLI) - ALEV YAYMAYAN  | 8         | 600,52    |
| 001 046 092698 00 17 | 138x226x98 TERMOPLASTİK BUAT - ALEV YAYMAYAN                   | 8         | 640,23    |
| 001 046 096131 00 44 | 138x226x131 TERMOPLASTİK BUAT (ŞEFFAF KAPAKLI) - ALEV YAYMAYAN | 8         | 647,03    |
| 001 046 096131 00 17 | 138x226x131 TERMOPLASTİK BUAT - ALEV YAYMAYAN                  | 8         | 726,37    |
| 001 046 098226 00 17 | 138x226x127 KOMBİNASYON KUTUSU - ALEV YAYMAYAN                 | 8         | 809,47    |



001 046 091199 00 44



001 046 091199 00 17



001 046 091130 00 44



001 046 091130 00 17



001 046 095311 00 17

## ALEV YAYMAYAN TERMOPLASTİK BUATLAR VE KOMBİNASYON KUTULARI

| Ürün Kodu            | Ürün Adı   | Koli Adet | Fiyat (₺) |
|----------------------|--|-----------|-----------|
| 001 046 091199 00 44 | 225x311x99 TERMOPLASTİK BUAT (ŞEFFAF KAPAKLI) - ALEV YAYMAYAN  | 4         | 1.031,64  |
| 001 046 091199 00 17 | 225x311x99 TERMOPLASTİK BUAT - ALEV YAYMAYAN                   | 4         | 1.096,51  |
| 001 046 091130 00 44 | 225x311x130 TERMOPLASTİK BUAT (ŞEFFAF KAPAKLI) - ALEV YAYMAYAN | 4         | 1.044,94  |
| 001 046 091130 00 17 | 225x311x130 TERMOPLASTİK BUAT - ALEV YAYMAYAN                  | 4         | 1.185,83  |
| 001 046 095311 00 17 | 225x311x132 KOMBİNASYON KUTUSU - ALEV YAYMAYAN                 | 4         | 1.333,33  |



010 104 000180



010 104 000181



010 104 000182



010 104 000183

## KOMBİNASYON PANOLARI

| Ürün Kodu      | Ürün Adı                                    | Koli Adet | Fiyat (₺) |
|----------------|---|-----------|-----------|
| 010 104 000180 | MK-325-2 3x25A 1 ADET ÖN + 1x16A 2 ADET YAN | 4         | 1.269,44  |
| 010 104 000181 | MK-516-1 5x16A 1 ADET ÖN + 1x16A 1 ADET YAN | 6         | 962,52    |
| 010 104 000182 | MK-516-2 5x16A 1 ADET ÖN + 1x16A 2 ADET YAN | 4         | 1.538,78  |
| 010 104 000183 | MK-532-1 5x32A 1 ADET ÖN + 1x16A 1 ADET YAN | 6         | 1.089,68  |



010 104 000184



010 104 000185



010 104 000186



010 104 000187

| Ürün Kodu      | Ürün Adı                                      | Koli Adet | Fiyat (₺) |
|----------------|---|-----------|-----------|
| 010 104 000184 | MK-532-2 5x32 A 1 ADET ÖN + 1x16A 2 ADET YAN  | 4         | 1.669,38  |
| 010 104 000185 | MK-2325-2 3x25 A 2 ADET ÖN + 1x16A 2 ADET YAN | 4         | 1.979,02  |
| 010 104 000186 | MK-2516-2 5x16A 2 ADET ÖN + 1x16A 2 ADET YAN  | 4         | 2.517,06  |
| 010 104 000187 | MK-2516-4 5x16 A 2 ADET ÖN + 1x16A 4 ADET YAN | 4         | 2.855,41  |



010 104 000188



010 104 000189



010 104 000190



010 104 000191



010 104 000192

| Ürün Kodu      | Ürün Adı   | Koli Adet | Fiyat (₺) |
|----------------|--|-----------|-----------|
| 010 104 000188 | MK-2532-2 5x32A 2 ADET ÖN + 1x16A 2 ADET YAN                     | 4         | 2.773,38  |
| 010 104 000189 | MK-2532-4 5x32A 2 ADET ÖN + 1x16A 4 ADET YAN                     | 4         | 3.113,82  |
| 010 104 000190 | MK-5164-4 5x16A 4 ADET ÖN + 1x16A 4 ADET YAN                     | 3         | 4.699,14  |
| 010 104 000191 | MK-5324-4 5x32A 4 ADET ÖN + 1x16A 4 ADET YAN                     | 3         | 5.213,22  |
| 010 104 000192 | MK-51632-4 5x16A 2 ADET ÖN + 5x32 A 2 ADET ÖN + 1x16A 4 ADET YAN | 3         | 4.954,81  |



010 104 000120



010 104 000121



010 104 000122



010 104 000123



010 104 000124



010 104 000125



010 104 000126



010 104 000127



010 090 050009



010 104 000129



010 104 000130



010 104 000133

## KUTU MONTAJLI ÜRÜNLER

| Ürün Kodu      | Ürün Adı  | Koli Adet | Fiyat (₺) |
|----------------|---|-----------|-----------|
| 010 104 000120 | MS-KK31 1'Lİ KUTULU START BUTONU (1NO)                            | 18        | 283,52    |
| 010 104 000121 | MS-KK42 1'Lİ KUTULU STOP BUTONU (1NC)                             | 18        | 283,52    |
| 010 104 000122 | MS-KK51 1'Lİ KUTULU START BUTONU (1NO)                            | 18        | 283,52    |
| 010 104 000123 | MS-BX71 1'Lİ KUTULU ALARM BUTONU (1NO)                            | 18        | 296,00    |
| 010 104 000124 | MS-BX81 1'Lİ KUTULU AYDINLATMA BUTONU (1NO)                       | 18        | 296,00    |
| 010 104 000125 | MS-KK7325 1'Lİ KUTULU İKİZ BUTONU (1NO+1NC)                       | 18        | 402,60    |
| 010 104 000126 | MS-KK4151 1'Lİ KUTULU İŞARETLİ İKİZ BUTONU (1NO+1NO)              | 18        | 413,94    |
| 010 104 000127 | MS-KBZ 1'Lİ KUTULU KABİN ALTI İKAZ LAMBASI BUZZERLİ               | 18        | 487,66    |
| 010 090 050009 | MS-BX542 1'Lİ KUTULU ACİL STOP BUTONU (1NC)                       | 18        | 340,23    |
| 010 104 000129 | MS-BX542E 1'Lİ KUTULU EMERGENCY STOP BUTONU (1NC)                 | 18        | 351,57    |
| 010 104 000130 | MS-BX542ASP 1'Lİ KUTULU MÜHÜRLÜ TİP KORUMA ACİL STOP BUTONU (1NC) | 12        | 612,41    |
| 010 104 000133 | MS-KANT 1'Lİ KUTULU KAYICI RESET ANAHTARI                         | 12        | 464,98    |



010 104 000105



010 104 000106



010 104 000107



010 104 000156

## EKO SERİSİ KUMANDA KUTULARI

| Ürün Kodu      | Ürün Adı  | Koli Adet | Fiyat (₺) |
|----------------|---|-----------|-----------|
| 010 104 000105 | EKO101S EKO 1'Lİ BOŞ KUMANDA KUTUSU                       | 90        | 61,82     |
| 010 104 000106 | EKO201S EKO 1'Lİ KORUMALI BOŞ KUMANDA KUTUSU              | 50        | 67,65     |
| 010 104 000107 | EKO301S EKO 1'Lİ ACİL STOP ETİKETLİ YAZILI KUMANDA KUTUSU | 50        | 267,90    |
| 010 104 000156 | EKO401S EKO 1'Lİ ACİL STOPLU KUMANDA KUTUSU               | 50        | 261,03    |



010 091 01XX01



010 091 01XX02



010 091 01XX03



010 091 01XX04



010 104 000114



010 104 000115



010 104 000116



010 104 000117

## BOŞ KUMANDA KUTULARI

XX yerine Gri için 00, Sarı için 14 rakamını yazınız.

| Ürün Kodu      | Ürün Adı                                  | Koli Adet | Fiyat (₺) |
|----------------|---|-----------|-----------|
| 010 091 01XX01 | 1'Lİ ETANJ BUTON KUTUSU EUROBOX           | 24        | 121,10    |
| 010 091 01XX02 | 2'Lİ ETANJ BUTON KUTUSU EUROBOX           | 18        | 152,01    |
| 010 091 01XX03 | 3'LÜ ETANJ BUTON KUTUSU EUROBOX           | 12        | 203,67    |
| 010 091 01XX04 | 4'LÜ ETANJ BUTON KUTUSU EUROBOX           | 10        | 236,99    |
| 010 104 000114 | SW-BX055B 5'Lİ ETANJ BUTON KUTUSU EUROBOX | 8         | 314,56    |
| 010 104 000115 | SW-BX065B 6'Lİ ETANJ BUTON KUTUSU EUROBOX | 8         | 346,76    |
| 010 104 000116 | SW-BX075B 7'Lİ ETANJ BUTON KUTUSU EUROBOX | 6         | 366,57    |
| 010 104 000117 | SW-BX085B 8'Lİ ETANJ BUTON KUTUSU EUROBOX | 6         | 391,34    |



## ASANSÖR KUYU DİBİ SETLERİ VE KUMANDALARI

| Ürün Kodu      | Ürün Adı  | Koli Adet | Fiyat (₺) |
|----------------|---|-----------|-----------|
| 010 104 000134 | MS-KYD02 2'Lİ ASANSÖR KUYU DİBİ BUTON 220V 16A TOPRAKLAMALI PRİZ + ACİL STOP BUTON  | 9         | 592,05    |
| 010 104 000135 | MS-KYD03 ACİL STOP BUTON + SEÇİCİ BUTON (2NO) 220V 16A TOPRAKLAMALI PANO PRİZİ  | 6         | 899,69    |
| 010 104 000136 | MS-KYD04 6'Lİ ACİL STOP BUTON + 2 ADET OKLU BUTON (1NO) 1 İKİZ BUTON ( 2NO) 1 SEÇİCİ BUTON (2NO)                              | 5         | 1.474,32  |
| 010 104 000137 | MS-KYD05 ACİL STOP BUTON + 2 OKLU BUTON ORTAK OKLU (1NO) SEÇİCİ BUTON (2NO-1NC)   | 4         | 1.358,23  |
| 010 104 000138 | MS-KYD06 ACİL STOP BUTON + 2 OKLU BUTON (2NO)1 ORTAK BUTON (1NO) ALARM BUTONU +SEÇİCİ BUTON (2NO-1NC)                         | 2         | 1.474,32  |
| 010 104 000139 | KY2-ALR KORUMALI ACİL STOP BUTON (1NC)NO KONTAKLI ALARM BUTONU KOMBİNASYON  | 10        | 592,05    |
| 010 104 000140 | MS-KY5-24 KORUMALI ACİL STOP BUTON (1NC)LAMBA VAVİEN (1NO)24V KATTA LED (1NO) ALARM BUTON 16A KAPAKLI PRİZ                    | 4         | 1.543,98  |
| 010 104 000141 | MS-KY3 KORUMALI ACİL STOP BUTON + ALARM BUTON +16A KAPAKLI PRİZ KOMBİNASYON   | 5         | 859,05    |
| 010 104 000142 | MS-KY3ES5012 KORUMALI ACİL STOP BUTON + ALARM + 9V PİLLİ 130 dB KOMBİNASYON   | 5         | 1.393,06  |
| 010 104 000143 | MS-KY4ES5012 KORUMALI ACİL STOP BUTON + 9V PİLLİ 130 dB ALARM + 16A KAPAKLI PRİZ KOMBİNASYON                                  | 4         | 1.543,98  |
| 010 091 020001 | MS-LV4 YUKARI (1NO) AŞAĞI (1NO) 0-1 REVİZYON (1NO) ACİL STOP BUTON (1NC) EL TERMİNALİ (EL KUMANDA)                            | 6         | 1.091,23  |
| 010 104 000145 | MS-LV5 YUKARI (1NO) ORTAK (1NO) AŞAĞI (1NO) 0-1 REVİZYON (1NO) ACİL STOP BUTON (1NC) 16A KAPAKLI PRİZ EL TERMİNALİ            | 4         | 1.543,98  |
| 010 104 000146 | MS3BY-BG53P 3KADEME BY-PASSLI LAMBA BUTON (1NO) 24V KATTA LEDLİ REG.AÇMA (1NO) 16A KAPAKLI PRİZ KOMBİN.                       | 4         | 2.112,81  |
| 010 104 000147 | MS9-BX07 YUKARI (1NO) AŞAĞI (1NO) ORTAK (1NO) 24V KATTA LEDLİ KOR. ACİL STOP(1NC) ALARM (1NO) LAMBA (1NO)KOR. 0-1REV.(1NO)16A | 1         | 2.275,33  |
| 010 104 000148 | MS102-ED21 3BY 3KADEME BY-PASSLI REG.KİLİT (1NO) REG.AÇ(1NO) 24V KATTA LED FREN AÇMA (1NO) KOR.0-1SET RESET (1NO)             | 4         | 2.344,99  |
| 010 104 000149 | MS201-ED21 REG.AÇ KAPA (2NO)24V KATTA LED LAMBA BUTON (1NO) FREN AÇMA1 (1NO) FREN AÇMA2(1NO) KORUMA SET RESET (2NO)           | 4         | 1.567,19  |



## VİNÇ KUTULARI

| Ürün Kodu      | Ürün Adı                       | Kutu Adet | Fiyat (₺) |
|----------------|--------------------------------|-----------|-----------|
| 010 092 000001 | İKİLİ VİNÇ KUTUSU - TEK HIZLI  | 1         | 1.559,38  |
| 010 092 000002 | ÜÇLÜ VİNÇ KUTUSU - TEK HIZLI   | 1         | 1.778,47  |
| 010 092 000003 | DÖRTLÜ VİNÇ KUTUSU - TEK HIZLI | 1         | 2.010,44  |
| 010 092 000004 | BEŞLİ VİNÇ KUTUSU - TEK HIZLI  | 1         | 2.233,82  |
| 010 092 000005 | ALTILI VİNÇ KUTUSU - TEK HIZLI | 1         | 2.723,54  |
| 010 092 000006 | YEDİLİ VİNÇ KUTUSU - TEK HIZLI | 1         | 2.946,93  |



010 104 000003



010 104 000004



010 104 000005



010 104 000006



010 104 000007



010 104 000008

## SWISS SERİSİ PLASTİK YAYLI BUTONLAR

| Ürün Kodu      | Ürün Adı                                  | Kutu Adet | Fiyat (₺) |
|----------------|---|-----------|-----------|
| 010 104 000003 | SW-AA42 22 mm PLASTİK YAYLI BUTON - STOP  | 10        | 123,05    |
| 010 104 000004 | SW-AA31 22 mm PLASTİK YAYLI BUTON - START | 10        | 123,05    |
| 010 104 000005 | SW-AA51 22 mm PLASTİK YAYLI BUTON - START | 10        | 123,05    |
| 010 104 000006 | SW-AA61 22 mm PLASTİK YAYLI BUTON - START | 10        | 123,05    |
| 010 104 000007 | SW-AA21 22 mm PLASTİK YAYLI BUTON - START | 10        | 123,05    |
| 010 104 000008 | SW-AA11 22 mm PLASTİK YAYLI BUTON - START | 10        | 123,05    |



010 104 000009



010 104 000010



010 104 000011



010 104 000012



010 104 000013



010 104 000014

## SWISS SERİSİ PLASTİK YAYLI BUTONLAR

| Ürün Kodu      | Ürün Adı                                    | Kutu Adet | Fiyat (₺) |
|----------------|---|-----------|-----------|
| 010 104 000009 | SW-AA4322 22 mm PLASTİK YAYLI BUTON - STOP  | 10        | 129,28    |
| 010 104 000010 | SW-AA3361 22 mm PLASTİK YAYLI BUTON - START | 10        | 129,28    |
| 010 104 000011 | SW-AA3351 22 mm PLASTİK YAYLI BUTON - START | 10        | 129,28    |
| 010 104 000012 | SW-AA3341 22 mm PLASTİK YAYLI BUTON - START | 10        | 129,28    |
| 010 104 000013 | SW-AA3371 22 mm PLASTİK YAYLI BUTON - START | 10        | 129,28    |
| 010 104 000014 | SW-AA3381 22 mm PLASTİK YAYLI BUTON - START | 10        | 129,28    |



010 104 000015



010 104 000016



010 104 000017



010 104 000018



010 104 000019



010 104 000020



010 104 000021



010 104 000022



010 104 000023



010 104 000024

## SWISS SERİSİ PLASTİK YAYLI İKİZ BUTONLAR

| Ürün Kodu      | Ürün Adı  | Kutu Adet | Fiyat (₺) |
|----------------|---|-----------|-----------|
| 010 104 000015 | SW-AL7325 22 mm PLASTİK İKİZ BUTON (1NO+1NC)                              | 10        | 252,40    |
| 010 104 000016 | SW-AL7181 22 mm PLASTİK ALARM - LAMBA İKİZ BUTON (1NO+1NO)                | 10        | 277,91    |
| 010 104 000017 | SW-AL4252 22 mm PLASTİK YUKARI AŞAĞI OKLU TERS YÖNLÜ İKİZ BUTON (1NO+1NO) | 10        | 277,91    |
| 010 104 000018 | SW-AL6171 22 mm PLASTİK ALARM ORTAK OKLU İKİZ BUTON (1NO+1NO)             | 10        | 277,91    |
| 010 104 000019 | SW-AL6181 22 mm PLASTİK LAMBA ORTAK OKLU İKİZ BUTON (1NO+1NO)             | 10        | 277,91    |
| 010 104 000020 | SW-AL7425 22 mm PLASTİK İŞARETLİ İKİZ BUTON (1NO+1NC)                     | 10        | 277,91    |
| 010 104 000021 | SW-AL7525 22 mm PLASTİK YAZILI İKİZ BUTON (1NO+1NC)                       | 10        | 277,91    |
| 010 104 000022 | SW-AL4151 22 mm PLASTİK YUKARI AŞAĞI OKLU BUTON (1NO+1NO)                 | 10        | 277,91    |
| 010 104 000023 | SW-AL7465L 22 mm PLASTİK İKİZ BUTON (1NO+1NC) LEDLİ 220V AC/DC            | 10        | 467,43    |
| 010 104 000024 | SW-AL7465-24L 22 mm PLASTİK İKİZ BUTON (1NO+1NC) LEDLİ 24V AC/DC          | 10        | 467,43    |



010 104 000025



010 104 000026



010 104 000027



010 104 000028

## SWISS SERİSİ PLASTİK KALICI VE KAYICI MANDAL BUTONLAR

| Ürün Kodu      | Ürün Adı  | Kutu Adet | Fiyat (₺) |
|----------------|---|-----------|-----------|
| 010 104 000025 | SW-AD21 PLASTİK KALICI 0 - 1 MANDAL BUTON (1NO)         | 10        | 145,11    |
| 010 104 000026 | SW-AD41 PLASTİK KAYICI 0 - 1 MANDAL BUTON (1NO)         | 10        | 164,46    |
| 010 104 000027 | SW-AD33 PLASTİK KALICI 2 - 0 - 1 MANDAL BUTON (1NO+1NO) | 10        | 211,07    |
| 010 104 000028 | SW-AD53 PLASTİK KAYICI 2 - 0 - 1 MANDAL BUTON (1NO+1NO) | 10        | 228,66    |



010 104 000029



010 104 000030



010 104 000031



010 104 000032

## SWISS SERİSİ PLASTİK ANAHTARLI KALICI VE KAYICI MANDAL BUTONLAR

| Ürün Kodu      | Ürün Adı  | Kutu Adet | Fiyat (₺) |
|----------------|---|-----------|-----------|
| 010 104 000029 | SW-AG21 PLASTİK KALICI 0 - 1 ANAHTARLI MANDAL BUTON (1NO)         | 10        | 385,20    |
| 010 104 000030 | SW-AG41 PLASTİK KAYICI 0 - 1 ANAHTARLI MANDAL BUTON (1NO)         | 10        | 385,20    |
| 010 104 000031 | SW-AG33 PLASTİK KALICI 2 - 0 - 1 ANAHTARLI MANDAL BUTON (1NO+1NO) | 10        | 452,92    |
| 010 104 000032 | SW-AG53 PLASTİK KAYICI 2 - 0 - 1 ANAHTARLI MANDAL BUTON (1NO+1NO) | 10        | 452,92    |



010 104 000037



010 104 000038



010 104 000039

## SWISS SERİSİ PLASTİK KAYICI MANTAR BUTONLAR

| Ürün Kodu      | Ürün Adı   | Kutu Adet | Fiyat (₺) |
|----------------|--|-----------|-----------|
| 010 104 000037 | SW-AC42 40 mm KAFA PLASTİK KAYICI MANTAR BUTON (1NC) | 10        | 164,86    |
| 010 104 000038 | SW-AC31 40 mm KAFA PLASTİK KAYICI MANTAR BUTON (1NO) | 10        | 164,86    |
| 010 104 000039 | SW-AC51 40 mm KAFA PLASTİK KAYICI MANTAR BUTON (1NO) | 10        | 164,86    |



010 104 000033



010 104 000034



010 104 000035



010 104 000036

## SWISS SERİSİ PLASTİK MANTAR ACİL STOP BUTONLAR

| Ürün Kodu      | Ürün Adı   | Kutu Adet | Fiyat (₺) |
|----------------|--|-----------|-----------|
| 010 104 000033 | SW-AS142 40 mm KAFA PLASTİK ANAHTARLI MANTAR BUTON (1NC) ACİL STOP | 10        | 439,73    |
| 010 104 000034 | SW-AS542E 40 mm KAFA PLASTİK MANTAR BUTON (1NC) ACİL STOP ETİKETLİ | 10        | 206,07    |
| 010 104 000035 | SW-AS542 40 mm KAFA PLASTİK MANTAR BUTON (1NC) ACİL STOP           | 10        | 184,69    |
| 010 104 000036 | SW-AS442 30 mm KAFA PLASTİK MANTAR BUTON (1NC) ACİL STOP           | 10        | 184,69    |



010 104 000040  
010 104 000041



010 104 000042  
010 104 000043



010 104 000044  
010 104 000045



010 104 000046  
010 104 000047

## SWISS SERİSİ PLASTİK LEDLİ, İŞIKLI, YAYLI BUTONLAR

| Ürün Kodu      | Ürün Adı  | Kutu Adet | Fiyat (₺) |
|----------------|---|-----------|-----------|
| 010 104 000040 | SW-AW3475 22 mm LEDLİ İŞIKLI YAYLI BUTON STOP - 110-240V AC   | 10        | 360,58    |
| 010 104 000041 | SW-AW3475 22 mm LEDLİ İŞIKLI YAYLI BUTON STOP - 10-30V DC     | 10        | 360,58    |
| 010 104 000042 | SW-AW3375 22 mm LEDLİ İŞIKLI YAYLI BUTON START - 110-240V AC  | 10        | 360,58    |
| 010 104 000043 | SW-AW3375-24 22 mm LEDLİ İŞIKLI YAYLI BUTON START - 10-30V DC | 10        | 360,58    |
| 010 104 000044 | SW-AW3575 22 mm LEDLİ İŞIKLI YAYLI BUTON START - 110-240V AC  | 10        | 360,58    |
| 010 104 000045 | SW-AW3575-24 22 mm LEDLİ İŞIKLI YAYLI BUTON START - 10-30V DC | 10        | 360,58    |
| 010 104 000046 | SW-AW3675 22 mm LEDLİ İŞIKLI YAYLI BUTON START - 110-240V AC  | 10        | 360,58    |
| 010 104 000047 | SW-AW3675-24 22 mm LEDLİ İŞIKLI YAYLI BUTON START - 10-30V DC | 10        | 360,58    |



010 104 000054  
010 104 000057



010 104 000055  
010 104 000058



010 104 000056  
010 104 000059

## SWISS SERİSİ 1-0-2 PLASTİK LEDLİ, İŞIKLI KALICI MANDAL BUTONLAR

| Ürün Kodu      | Ürün Adı  | Kutu Adet | Fiyat (₺) |
|----------------|---|-----------|-----------|
| 010 104 000054 | SW-AK323L 1-0-2 PLASTİK LEDLİ KALICI MANDAL BUTON (2NO) 110-240V AC     | 10        | 451,58    |
| 010 104 000055 | SW-AK324L 1-0-2 PLASTİK LEDLİ KALICI MANDAL BUTON (2NC) 110-240V AC     | 10        | 451,58    |
| 010 104 000056 | SW-AK325L 1-0-2 PLASTİK LEDLİ KALICI MANDAL BUTON (2NO) 110-240V AC     | 10        | 451,58    |
| 010 104 000057 | SW-AK323-24L 1-0-2 PLASTİK LEDLİ KALICI MANDAL BUTON (2NO) 10-24V AC/DC | 10        | 451,58    |
| 010 104 000058 | SW-AK324-24L 1-0-2 PLASTİK LEDLİ KALICI MANDAL BUTON (2NC) 10-24V AC/DC | 10        | 451,58    |
| 010 104 000059 | SW-AK325-24L 1-0-2 PLASTİK LEDLİ KALICI MANDAL BUTON (2NO) 10-24V AC/DC | 10        | 451,58    |



010 104 000048  
010 104 000051



010 104 000049  
010 104 000052



010 104 000050  
010 104 000053

## SWISS SERİSİ 0-1 PLASTİK LEDLİ, İŞIKLI KALICI MANDAL BUTONLAR

| Ürün Kodu      | Ürün Adı  | Kutu Adet | Fiyat (₺) |
|----------------|---|-----------|-----------|
| 010 104 000048 | SW-AK123L 0-1 PLASTİK LEDLİ KALICI MANDAL BUTON (1NO) 110-240V AC     | 10        | 382,56    |
| 010 104 000049 | SW-AK124L 0-1 PLASTİK LEDLİ KALICI MANDAL BUTON (1NC) 110-240V AC     | 10        | 382,56    |
| 010 104 000050 | SW-AK125L 0-1 PLASTİK LEDLİ KALICI MANDAL BUTON (1NO) 110-240V AC     | 10        | 382,56    |
| 010 104 000051 | SW-AK123-24L 0-1 PLASTİK LEDLİ KALICI MANDAL BUTON (1NO) 10-24V AC/DC | 10        | 382,56    |
| 010 104 000052 | SW-AK124-24L 0-1 PLASTİK LEDLİ KALICI MANDAL BUTON (1NC) 10-24V AC/DC | 10        | 382,56    |
| 010 104 000053 | SW-AK125-24L 0-1 PLASTİK LEDLİ KALICI MANDAL BUTON (1NO) 10-24V AC/DC | 10        | 382,56    |



010 104 000001



010 104 000002

## POTANSİYOMETRE

| Ürün Kodu      | Ürün Adı            | Kutu Adet | Fiyat (₺) |
|----------------|---------------------|-----------|-----------|
| 010 104 000001 | MS22-5K POTANS 5K   | 15        | 669,74    |
| 010 104 000002 | MS22-10K POTANS 10K | 15        | 669,74    |



010 104 000064



010 104 000065



010 104 000066



010 104 000067



010 104 000068



010 104 000069

## SWISS SERİSİ METAL KAPLAMALI YAYLI BUTONLAR

| Ürün Kodu      | Ürün Adı                              | Kutu Adet | Fiyat (₺) |
|----------------|---------------------------------------|-----------|-----------|
| 010 104 000064 | SW-BA42 22 mm YAYLI BUTON STOP (1NC)  | 10        | 136,32    |
| 010 104 000065 | SW-BA31 22 mm YAYLI BUTON START (1NO) | 10        | 136,32    |
| 010 104 000066 | SW-BA51 22 mm YAYLI BUTON START (1NO) | 10        | 136,32    |
| 010 104 000067 | SW-BA11 22 mm YAYLI BUTON START (1NO) | 10        | 136,32    |
| 010 104 000068 | SW-BA61 22 mm YAYLI BUTON START (1NO) | 10        | 136,32    |
| 010 104 000069 | SW-BA21 22 mm YAYLI BUTON START (1NO) | 10        | 136,32    |



010 104 000071



010 104 000072



010 104 000073



010 104 000074



010 104 000075



010 104 000076

## SWISS SERİSİ METAL KAPLAMALI İŞARETLİ YAYLI BUTONLAR

| Ürün Kodu      | Ürün Adı   | Kutu Adet | Fiyat (₺) |
|----------------|--|-----------|-----------|
| 010 104 000071 | SW-BA4322 22 mm İŞARETLİ YAYLI BUTON STOP (1NC)  | 10        | 148,59    |
| 010 104 000072 | SW-BA3351 22 mm İŞARETLİ YAYLI BUTON START (1NO) | 10        | 148,59    |
| 010 104 000073 | SW-BA3341 22 mm İŞARETLİ YAYLI BUTON START (1NO) | 10        | 148,59    |
| 010 104 000074 | SW-BA3361 22 mm İŞARETLİ YAYLI BUTON START (1NO) | 10        | 148,59    |
| 010 104 000075 | SW-BA3371 22 mm İŞARETLİ YAYLI BUTON START (1NO) | 10        | 148,59    |
| 010 104 000076 | SW-BA3381 22 mm İŞARETLİ YAYLI BUTON START (1NO) | 10        | 148,59    |



010 104 000077



010 104 000078



010 104 000079

## SWISS SERİSİ METAL KAPLAMALI İKİZ BUTONLAR

| Ürün Kodu      | Ürün Adı  | Kutu Adet | Fiyat (₺) |
|----------------|---|-----------|-----------|
| 010 104 000077 | SW-BL7325 22 mm PLASTİK İKİZ BUTON (1NO+1NC)        | 10        | 277,03    |
| 010 104 000078 | SW-BL7425 22 mm PLASTİK İKİZ BUTON (1NO+1NC)        | 10        | 306,47    |
| 010 104 000079 | SW-BL7525 22 mm PLASTİK YAZILI İKİZ BUTON (1NO+1NC) | 10        | 306,47    |



010 104 000080

010 104 000081

010 104 000082

010 104 000083

010 104 000084

010 104 000085

010 104 000086

## SWISS SERİSİ METAL KAPLAMALI İKİZ BUTONLAR

| Ürün Kodu      | Ürün Adı  | Kutu Adet | Fiyat (₺) |
|----------------|---|-----------|-----------|
| 010 104 000080 | SW-BL4151 22 mm PLASTİK YUKARI AŞAĞI OKLU İKİZ BUTON (1NO+1NO)          | 10        | 306,47    |
| 010 104 000081 | SW-BL4252 22 mm PLASTİK YUKARI AŞAĞI TERS YÖN OKLU İKİZ BUTON (1NO+1NO) | 10        | 306,47    |
| 010 104 000082 | SW-BL6171 22 mm PLASTİK ALARM ORTAK OKLU İKİZ BUTON (1NO+1NO)           | 10        | 306,47    |
| 010 104 000083 | SW-BL7181 22 mm PLASTİK ALARM - LAMBA İKİZ BUTON (1NO+1NO)              | 10        | 306,47    |
| 010 104 000084 | SW-BL6181 22 mm PLASTİK LAMBA ORTAK OKLU İKİZ BUTON (1NO+1NO)           | 10        | 306,47    |
| 010 104 000085 | SW-BL7465L 22 mm PLASTİK İKİZ BUTON LEDLİ (220V AC)                     | 10        | 514,48    |
| 010 104 000086 | SW-BL7465L-24L 22 mm PLASTİK İKİZ BUTON LEDLİ (24V AC/DC)               | 10        | 514,48    |



010 104 000087



010 104 000088



010 104 000089



010 104 000090

## SWISS SERİSİ METAL KAPLAMALI KALICI VE KAYICI MANDAL BUTONLAR

| Ürün Kodu      | Ürün Adı                                    | Kutu Adet | Fiyat (₺) |
|----------------|---|-----------|-----------|
| 010 104 000087 | SW-BD21 0-1 KALICI MANDAL BUTON (1NO)       | 10        | 159,62    |
| 010 104 000088 | SW-BD41 0-1 KAYICI MANDAL BUTON (1NO)       | 10        | 180,29    |
| 010 104 000089 | SW-BD33 1-0-2 KALICI MANDAL BUTON (1NO+1NO) | 10        | 233,06    |
| 010 104 000090 | SW-BD53 1-0-2 KAYICI MANDAL BUTON (1NO+1NO) | 10        | 255,04    |



010 104 000168



010 104 000169



010 104 000170



010 104 000171



010 104 000172



010 104 000173

## SWISS SERİSİ METAL KAPLAMALI 0-1 LEDLİ KALICI BUTONLAR

| Ürün Kodu      | Ürün Adı  | Kutu Adet | Fiyat (₺) |
|----------------|---|-----------|-----------|
| 010 104 000168 | SW-BK123L 0-1 LEDLİ İŞIKLI KALICI MANDAL BUTON (1NO) 110-240V AC      | 10        | 394,88    |
| 010 104 000169 | SW-BK124L 0-1 LEDLİ İŞIKLI KALICI MANDAL BUTON (1NC) 110-240V AC      | 10        | 394,88    |
| 010 104 000170 | SW-BK125L 0-1 LEDLİ İŞIKLI KALICI MANDAL BUTON (1NO) 110-240V AC      | 10        | 394,88    |
| 010 104 000171 | SW-BK123L-24L 0-1 LEDLİ İŞIKLI KALICI MANDAL BUTON (1NO) 10-30V AC/DC | 10        | 394,88    |
| 010 104 000172 | SW-BK124L-24L 0-1 LEDLİ İŞIKLI KALICI MANDAL BUTON (1NC) 10-30V AC/DC | 10        | 394,88    |
| 010 104 000173 | SW-BK125L-24L 0-1 LEDLİ İŞIKLI KALICI MANDAL BUTON (1NC) 10-30V AC/DC | 10        | 394,88    |



010 104 000160



010 104 000162



010 104 000164



010 104 000166



010 104 000161



010 104 000163



010 104 000165



010 104 000167

## SWISS SERİSİ METAL KAPLAMALI LEDLİ İŞIKLI YAYLI BUTONLAR

| Ürün Kodu      | Ürün Adı  | Kutu Adet | Fiyat (₺) |
|----------------|---|-----------|-----------|
| 010 104 000160 | BW-3475 22 mm LEDLİ İŞIKLI YAYLI BUTON STOP 110-240V AC       | 10        | 369,37    |
| 010 104 000161 | BW-3475-24L 22 mm LEDLİ İŞIKLI YAYLI BUTON STOP 10-30V AC/DC  | 10        | 369,37    |
| 010 104 000162 | BW-3375 22 mm LEDLİ İŞIKLI YAYLI BUTON START 110-240V AC      | 10        | 369,37    |
| 010 104 000163 | BW-3375-24L 22 mm LEDLİ İŞIKLI YAYLI BUTON START 10-30V AC/DC | 10        | 369,37    |
| 010 104 000164 | BW-3575 22 mm LEDLİ İŞIKLI YAYLI BUTON START 110-240V AC      | 10        | 369,37    |
| 010 104 000165 | BW-3575-24L 22 mm LEDLİ İŞIKLI YAYLI BUTON START 10-30V AC/DC | 10        | 369,37    |
| 010 104 000166 | BW-3675 22 mm LEDLİ İŞIKLI YAYLI BUTON START 110-240V AC      | 10        | 369,37    |
| 010 104 000167 | BW-3675-24L 22 mm LEDLİ İŞIKLI YAYLI BUTON START 10-30V AC/DC | 10        | 369,37    |



010 104 000174



010 104 000175



010 104 000176



010 104 000177



010 104 000178



010 104 000179

## SWISS SERİSİ METAL KAPLAMALI 0-1-2 LEDLİ KALICI MANDAL BUTONLAR

| Ürün Kodu      | Ürün Adı  | Kutu Adet | Fiyat (₺) |
|----------------|---|-----------|-----------|
| 010 104 000174 | BK-323L 1-0-2 PLASTİK LEDLİ KALICI MANDAL BUTON (2NO) 110-240V AC     | 10        | 460,87    |
| 010 104 000175 | BK-324L 1-0-2 PLASTİK LEDLİ KALICI MANDAL BUTON (2NC) 110-240V AC     | 10        | 460,87    |
| 010 104 000176 | BK-325L 1-0-2 PLASTİK LEDLİ KALICI MANDAL BUTON (2NO) 110-240V AC     | 10        | 460,87    |
| 010 104 000177 | BK-323-24L 1-0-2 PLASTİK LEDLİ KALICI MANDAL BUTON (2NO) 10-24V AC/DC | 10        | 460,87    |
| 010 104 000178 | BK-324-24L 1-0-2 PLASTİK LEDLİ KALICI MANDAL BUTON (2NC) 10-24V AC/DC | 10        | 460,87    |
| 010 104 000179 | BK-325-24L 1-0-2 PLASTİK LEDLİ KALICI MANDAL BUTON (2NO) 10-24V AC/DC | 10        | 460,87    |



010 104 000060



010 104 000061



010 104 000062

## YAYLI BUTON YEDEK KONTAKLARI VE KILIFI

| Ürün Kodu      | Ürün Adı                               | Kutu Adet | Fiyat (₺) |
|----------------|--|-----------|-----------|
| 010 104 000060 | SW-BE101 KONTAK BLOK (NO)              | 50        | 68,60     |
| 010 104 000061 | SW-BE102 KONTAK BLOK (NC)              | 50        | 68,60     |
| 010 104 000062 | SW-BE103 İŞIK SOKETİ 10/30 110-240V AC | 50        | 237,45    |



010 104 000091



010 104 000092



010 104 000093



010 093 000002



010 093 000001



010 093 000099

## BUTON AKSESUARLARI

| Ürün Kodu      | Ürün Adı   | Kutu Adet | Fiyat (₺) |
|----------------|--|-----------|-----------|
| 010 104 000091 | SW-BR1 PLASTİK BUTON ROZETİ 26x8 CAMLI                     | 100       | 46,61     |
| 010 104 000092 | SW-BR2 PLASTİK BUTON ROZETİ 26x18 CAMLI                    | 100       | 52,77     |
| 010 104 000093 | SW-SIE-R PLASTİK BUTON ROZETİ 27x12 CAMSIZ                 | 100       | 41,33     |
| 010 093 000002 | SW-BRY PLASTİK YAZILI BUTON ROZETİ                         | 100       | 25,50     |
| 010 093 000001 | SW-AP2 BUTON KORUMA KILIFI (YAYLI BUTONLAR İÇİN)           | 50        | 51,85     |
| 010 104 000099 | SW-AP4 IP67 İKİZ BUTON KORUMA KILIFI (YAYLI BUTONLAR İÇİN) | 50        | 51,85     |



010 104 000213



010 104 000214  
010 104 000215  
010 104 000216  
010 104 000217



010 090 050008



010 104 000101



010 104 000096



010 093 000003



010 104 000104

## ACİL STOP ETİKETLERİ

| Ürün Kodu      | Ürün Adı   | Kutu Adet | Fiyat (₺) |
|----------------|--|-----------|-----------|
| 010 104 000213 | SW-ASP TAM KAPAKLI MÜHÜRLÜ ACİL STOK KORUMA KAPAĞI                 | 10        | 103,04    |
| 010 104 000214 | SW-SY60L SÜREKLİ YANAR LEDLİ ETİKET 220V                           | 25        | 592,46    |
| 010 104 000215 | SW-SY60-24 SÜREKLİ YANAR LEDLİ ETİKET 24V                          | 25        | 592,46    |
| 010 104 000216 | SW-FY60L FLAŞ YANAR LEDLİ ETİKET 220V                              | 25        | 592,46    |
| 010 104 000217 | SW-FY60L-24 FLAŞ YANAR LEDLİ ETİKET 24V                            | 25        | 592,46    |
| 010 104 000096 | SW-ER60EN-Y Ø60 mm PLASTİK EMERGENCY ROZETİ (İNCE TİP) LAZER BASKI | 50        | 43,97     |
| 010 093 000003 | ACİL DURDURMA ETİKETİ  | 50        | 41,33     |
| 010 090 050008 | SW-AKKM EMNİYET BASMA DÜĞMESİ MUHAFAZA                             | 50        | 36,84     |
| 010 104 000101 | SW-AKK ACİL STOP KORUMA KAPAĞI                                     | 50        | 51,00     |
| 010 104 000104 | SW-MKKY MANDAL BUTON KORUMA KAPAĞI                                 | 50        | 42,50     |



999 999 995000

999 999 995001

999 999 995002

## VOLTMETRE VE AMPERMETRE

| Ürün Kodu      | Ürün Adı  | Kutu Adet | Fiyat (₺) |
|----------------|---|-----------|-----------|
| 999 999 995000 | 22 mm VOLTMETRE PLASTİK LED GÖSTERGELİ 20-500V AC                                   | 10        | 334,87    |
| 999 999 995001 | 22 mm AMPERMETRE (AKIM TRAFOLU) PLASTİK LED GÖSTERGE 1A-100A AC / 60-380V AC        | 10        | 669,74    |
| 999 999 995002 | 22 mm VOLT + AMPERMETRE (AKIM TRAFOLU) PLASTİK LED GÖSTERGE 20-500V AC / 1A-100A AC | 10        | 839,75    |



010 090 01XX01

010 090 01XX05  
010 090 01XX06  
010 090 01XX07

010 090 01XX04  
010 090 07XX02

010 111 070001  
010 111 070002

### XX KARŞILIĞI OLAN RENK KODLARI

|       |      |      |       |         |
|-------|------|------|-------|---------|
| ○     | ●    | ●    | ●     | ●       |
| Beyaz | Mavi | Sarı | Yeşil | Kırmızı |
| 00    | 13   | 14   | 15    | 16      |

## MUTLUSAN SİNYAL VE KUMANDA BUTONLARI

| Ürün Kodu      | Ürün Adı                           | Kutu Adet | Fiyat (₺) |
|----------------|------------------------------------|-----------|-----------|
| 010 090 01XX01 | 10 mm KABLOLU SİNYAL ARMATÜRÜ      | 100       | 34,00     |
| 010 090 01XX05 | 14 mm SİNYAL ARMATÜRÜ - 12V        | 50        | 47,49     |
| 010 090 01XX06 | 14 mm SİNYAL ARMATÜRÜ - 24V        | 50        | 47,49     |
| 010 090 01XX07 | 14 mm SİNYAL ARMATÜRÜ - 220V       | 50        | 47,49     |
| 010 090 01XX04 | 22 mm SİNYAL ARMATÜRÜ LEDLİ - 220V | 24        | 72,13     |
| 010 090 07XX02 | 22 mm SİNYAL ARMATÜRÜ LEDLİ - 24V  | 24        | 69,65     |
| 010 111 070001 | BUZZER LEDLİ - 220V                | 24        | 257,59    |
| 010 111 070002 | BUZZER LEDLİ - 24V                 | 24        | 257,59    |